

PDF Book.
FREE to download and keep !!



William Wilberforce
On Friday July 26th 1833 as he lay on his deathbed Wilberforce exclaimed: "Thank God that I have lived to witness the day in which England is willing to give £20 million for the abolishment of slavery." (What would that be worth today ?)
He died three days later.

The Slavery Abolition Bill 1833 passed through the House of Lords, it received the Royal Assent (which means it became law) on 29 August 1833 and came into force on 1 August 1834. On that date slavery was abolished throughout the vast British Empire. The Act automatically applied as new possessions (principally in Africa) subsequently became part of the British Empire.

To know who rules over you. Simply find out who it is that you are not allowed to criticise.Voltaire

We, as White people, have been GAGGED!! Then bullied, insulted, demonised, and provoked, until we object and complain. We then get called *dirty names* like Nazi, Racist, White Extremist, etc, etc.

Our weak & corrupt Lib/Lab/Con Politicians are the problem. As of Jan 2021, the UK elections are years away. Check out Populism, and Nationalism ASAP. Become "WHITE WOKE" & Push Back.

Do it today, NOW!

Slavery lessons for
White Children.



That every White
Parent should learn,
and teach.

What your school 'knowingly' hid from you!



KILL A WHITE ON SIGHT AVENGE SLAVERY ?

The pamphlet above was being distributed by BLM in Scotland around June and July 2020.

Not a word in our Media about this. If anything was said it was very little, and I missed it.

Can you imagine the outcry if BLM had said ...
KILL A JEW ON SIGHT
or
KILL A MUSLIM ON SIGHT

Imagine if some "White" pressure group, had distributed any sort of pamphlet like this.

Black people need to face up to, and 100% own, their absolute complicity, in the Slave Trade.

Black African Slave Traders were always in charge of this industry.

Not White Europeans.

At all future elections
Vote for one of the Populist or
Nationalist parties.

Never again give your vote to
the Lib/Lab/Con tricksters.

Just vote for someone else.
But always, always, VOTE !!

They depend on voter apathy
to get away with what they do.



Black African Slave Traders Resisted Abolition by Britain

Tunde Obadina - Slave Trade: A Root Of Contemporary African Crisis

From <http://www.afbis.com/analysis/slave.htm>

"The past is what makes the present coherent,"

said Afro-American writer James Baldwin, and the past "will remain horrible for exactly as long as we refuse to assess it honestly."

Why go back five centuries to start an explanation of Africa's crisis in the late 1990s? Must every story of Africa's political and economic under-development begin with the contact with Europe?

The intention is not to produce another nationalist tract on how whites, driven by lust for material possession and armed with firearms, gin and a bag full of tricks, subjugated innocent Africans who were living blissfully close to nature.

The reason for looking back is that the root of the crisis facing African societies is their failure to come to terms with the consequences of that contact.

Portuguese seamen first landed in Africa in the fourth decade of the fifteenth century. From the outset they seized Africans and shipped them to Europe. In 1441 ten Africans were kidnapped from the Guinea coast and taken to Portugal as gifts to Prince Henry the Navigator. In subsequent expeditions to the West African coast, inhabitants were taken and shipped to Portugal to be sold as servants and objects of curiosity to households. In the Portuguese port of Lagos, where the first African slaves landed in 1442, the old slave market now serves as an art gallery.

Portuguese adventurers who sailed southeast along the Gulf of Guinea in 1472 landed on the coast of what became Nigeria. Others followed. They found people of varying cultures. Some lived in towns ruled by kings with nobility and courtiers, very much like the medieval societies they left behind them. A Dutch visitor to Benin City wrote in around 1600: "As you enter it, the town appears very great. You go into a great broad street, not paved, which seems to be seven or eight times broader than the Warmoes Street in Amsterdam...The houses in this town stand in good order, one close and even with the other, as the houses in Holland stand..." More than a century earlier Benin exchanged ambassadors with Portugal. But not all African societies were as developed. Some enjoyed village existence in primeval forests remote from outside influences.

Economics was the driving force.

From the outset, relations between Europe and Africa were economic. Portuguese merchants traded with Africans from trading posts they set up along the coast. They exchanged items like brass and copper bracelets for such products as pepper, cloth, beads and slaves - all part of an existing internal African trade. Domestic slavery was common in Africa and well before European slave buyers arrived, there was trading in humans. Black slaves were captured or bought by Arabs and exported across the Saharan desert to the Mediterranean and Near East.

In 1492, the Spaniard Christopher Columbus discovered for Europe a 'New World'. The find proved disastrous not only for the 'discovered' people but also for Africans. It marked the beginning of a triangular trade between Africa, Europe and the New World. European slave ships, mainly British and French, took people from Africa to the New World. They were initially taken to the West Indies to supplement local Indians decimated by the Spanish Conquistadors. The slave trade grew from a trickle to a flood, particularly from the seventeenth century onwards.

Portugal's monopoly in the obnoxious trade was broken in the sixteenth century when England followed by France and other European nations entered the trade. The English led in the business of transporting young Africans from their homeland to work in mines and till lands in the Americas.

Most slaves sold by Africans.

Estimates of the total human loss to Africa over the four centuries of the transatlantic slave trade range from 30 million to 200 million. At the initial stage of the trade parties of Europeans captured Africans in raids on communities in the coastal areas. But this soon gave way to buying slaves from African rulers and traders. The vast majority of slaves taken out of Africa were sold by African rulers, traders and a military aristocracy, who all grew wealthy from the business.

Most slaves were acquired through wars or by kidnapping.

The Portuguese Duarte Pacheco Pereira wrote in the early sixteenth century after a visit to Benin that the kingdom "is usually at war with its neighbours and takes many captives, whom we buy at twelve or fifteen brass bracelets each, or for copper bracelets, which they prize more." Olaudah Equiano, an ex-slave, described in his memoirs published in 1789 how African rulers carried out raids to capture slaves. "When a trader wants slaves, he applies to a chief for them, and tempts him with his wares. It is not extraordinary, if on this occasion he yields to the temptation with as little firmness, and accepts the price of his fellow creature's liberty with as little reluctance, as the enlightened merchant. Accordingly, he falls upon his neighbours, and a desperate battle ensues...if he prevails, and takes prisoners, he gratifies his avarice by selling them." Equiano was born in 1745 in an area under the kingdom of Benin. At the age of ten he was kidnapped by slave



William Wilberforce

On Friday July 26th 1833 as he lay on his deathbed Wilberforce exclaimed: "Thank God that I have lived to witness the day in which England is willing to give £20 million for the abolishment of slavery." (What would that be worth today?)

He died three days later.

The Slavery Abolition Bill 1833 passed through the House of Lords, it received the Royal Assent (which means it became law) on 29 August 1833 and came into force on 1 August 1834. On that date slavery was abolished throughout the vast British Empire.

The Act automatically applied as new possessions (principally in Africa) subsequently became part of the British Empire.

To know who rules over you. Simply find out who it is that you are not allowed to criticise.Voltaire

We, as White people, have been GAGGED!! Then bullied, insulted, demonised, and provoked, until we object and complain. We then get called *dirty names* like Nazi, Racist, White Extremist, etc, etc.

Our weak & corrupt Lib/Lab/Con Politicians are the problem. As of Jan 2021, the UK elections are years away. Check out Populism, and Nationalism ASAP. Become "WHITE WOKE" & Push Back.

Do it today, NOW!



William Wilberforce

On Friday July 26th 1833 as he lay on his deathbed Wilberforce exclaimed: "Thank God that I have lived to witness the day in which England is willing to give £20 million for the abolishment of slavery." (What would that be worth today ?)

He died three days later.

The Slavery Abolition Bill 1833 passed through the House of Lords, it received the Royal Assent (which means it became law) on 29 August 1833 and came into force on 1 August 1834. On that date slavery was abolished throughout the vast British Empire.

The Act automatically applied as new possessions (principally in Africa) subsequently became part of the British Empire.

To know who rules over you. Simply find out who it is that you are not allowed to criticise.Voltaire

We, as White people, have been GAGGED!! Then bullied, insulted, demonised, and provoked, until we object and complain. We then get called *dirty names* like Nazi, Racist, White Extremist, etc, etc.

Our weak & corrupt Lib/Lab/Con Politicians are the problem. As of Jan 2021, the UK elections are years away. Check out Populism, and Nationalism ASAP. Become "WHITE WOKE" & Push Back.

Do it today, NOW!

hunters who also took his sister. He was more fortunate than most other slaves. After serving in America, the West Indies and England he was able to save for and buy his freedom in 1756 at the age of twenty-one.

Ottobah Cugoano, who was about 13 years old when he was kidnapped in 1770 in Ajumako in today's Ghana, had no doubt the shared responsibility of Africans for the horrid business. Referring to his own capture Cugoano wrote after he regained his freedom "I must own, to the shame of my own countrymen, that I was first kidnapped and betrayed by some of my own complexion, who were the first cause of my exile and slavery." But he added, "If there were no buyers there would be no sellers." By the same token, if there were no sellers there would be no buyers.

A profitable trade.

European slave buyers made the greater profit from the despicable trade, but their African partners also prospered. Many grew strong and fat on profits made from selling their brethren. Tinubu square, commercial centre of today's Lagos and home to Nigeria's Central Bank, is named after a major nineteenth century slave trader. Madam Tinubu was born in Egbaland and rose from rags to riches by trading in slaves, salt and tobacco in Badagry. She later became one of Nigeria's pioneering nationalists.

Africa's rulers, traders and military aristocracy protected their interest in the slave trade. They discouraged Europeans from leaving the coastal areas to venture into the interior of the continent. European trading companies realised the benefit of dealing with African suppliers and not unnecessarily antagonising them. The companies could not have mustered the resources it would have taken to directly capture the tens of millions of people shipped out of Africa. It was far more sensible and safer to give Africans guns to fight the many wars that yielded captives for the trade. The slave trading network stretched deep into the Africa's interior. Slave trading firms were aware of their dependency on African suppliers. The Royal African Company, for instance, instructed its agents on the West coast "if any differences happen, to endeavour an amicable accommodation rather than use force." They were "to endeavour to live in all friendship with them" and "to hold frequent palavers with the Kings and the Great Men of the Country, and keep up a good correspondent with them, ingratiating yourself by such prudent methods" as may be deemed appropriate.

Africans faced with a new world.

Contact with Europe opened new images of the world for the African elite and presented them with products of a civilisation which as the centuries passed became more technologically differentiated from their own. The slave trade whetted their appetite for the products of a changing world. Sadly it was not only

tinpot rulers who were mesmerised by the glitters of western artefacts. An African slave in Cuba in the nineteenth century recalled how his people were captivated by the bright colour of European manufacturers. "It was the scarlet which did for the Africans: both the kings and the rest surrendered without a struggle. When the kings saw that the whites were taking out these scarlet handkerchiefs as if they were waving, they told the blacks, "Go on then, go get a scarlet handkerchief" and the blacks were so excited by the scarlet they ran down to the ships, like sheep and there were captured."

European traders saw the advantages of helping African kings and chiefs realise their desire to acquire western culture, if not for themselves then for their children. Hugh Crow, who commanded the last British slave ship to leave a British port, wrote "It has always been the practice of merchants and commanders of ships to Africa, to encourage the natives to send their children to England as it not only conciliates their friendship, and softens their manner, but adds greatly to the security of the traders." With their children in Europe, African chiefs were likely to be more accommodating, knowing full well their offspring could be held as ransom.

European powers also hoped that by entertaining African princes in Europe to win the friendship of their fathers. By far the most important reason why African rulers and traders participated in the slave trade was their desire for its material rewards and the power it brought. They were obsessed with the variety of goods available through the trade. Locally produced equivalents of some merchandise, like cloth and jewellery, existed but greater satisfaction and prestige was got from having imported varieties. The man with a warehouse full with goods from abroad was a powerful figure in the community, able to buy favours and influence with his ill-gotten wealth.

African traders resist abolition of obnoxious trade.

When Britain abolished the slave trade in 1807 it not only had to contend with opposition from white slavers but also from African rulers who had become accustomed to wealth gained from selling slaves or from taxes collected on slaves passed through their domain.

African slave-trading classes were greatly distressed by the news that legislators sitting in parliament in London had decided to end their source of livelihood. But for as long as there was demand from the Americas for slaves, the lucrative business continued.

English missionary and abolitionist Thomas Buxton wrote in 1840 that the best way to suppress the slave trade was to offer Africa's slaving elites legitimate business that would give them means to satisfy their hunger for Western goods.



William Wilberforce

On Friday July 26th 1833 as he lay on his deathbed Wilberforce exclaimed: "Thank God that I have lived to witness the day in which England is willing to give £20 million for the abolishment of slavery." (What would that be worth today?)

He died three days later.

The Slavery Abolition Bill 1833 passed through the House of Lords, it received the Royal Assent (which means it became law) on 29 August 1833 and came into force on 1 August 1834.

On that date slavery was abolished throughout the vast British Empire.

The Act automatically applied as new possessions (principally in Africa) subsequently became part of the British Empire.

To know who rules over you. Simply find out who it is that you are not allowed to criticise.Voltaire

We, as White people, have been GAGGED!! Then bullied, insulted, demonised, and provoked, until we object and complain. We then get called *dirty names* like Nazi, Racist, White Extremist, etc, etc.

Our weak & corrupt Lib/Lab/Con Politicians are the problem. As of Jan 2021, the UK elections are years away. Check out Populism, and Nationalism ASAP. Become "WHITE WOKE" & Push Back.

Do it today, NOW!

"The African has acquired a taste for the civilised world. They have become essential to his. To say that the African, under present circumstances, shall not deal in man, is to say he shall long in vain for his accustomed gratification." This was the crux of the African condition.

The slave trade business continued in many parts of Africa for many decades after the British abolished it. For as long as there was demand for slave labour in the Americas, the supply was available. The British set up a naval blockade to stop ships carrying slaves from West Africa, but it was not very effective in suppressing the trade. Thousands of slave ships were detained during the decades the blockade was in operation. One Lieutenant Patrick Forbes, a British naval officer, estimated in 1849 that during a period of 26 years 103,000 slaves were emancipated by the warships of the naval blockade while ships carrying 1,795,000 slaves managed to slip past the blockage and land their cargo in the Americas.

British efforts to suppress the trade made it even more profitable because the price of slaves rose in the Americas. The numerous wars that plagued Yorubaland for half a century following the fall of the Oyo empire was largely driven by demand for slaves. Reverend Samuel Johnson wrote of the subjugation of neighbouring Yoruba kingdoms by Ibadan war-chiefs in the 1850s: "Slave-raiding now became a trade to many who would get rich speedily." It took the intervention of British colonialism to impose peace in Yorubaland in 1893. Slave trading for export ended in Nigeria and elsewhere in West Africa after slavery ended in the Spanish colonies of Brazil and Cuba in 1880. A consequence of the ending of the slave trade was the expansion of domestic slavery as African businessmen replaced trade in human chattel with increased export of primary commodities. Labour was needed to cultivate the new source of wealth for the African elites.

What if the West not abolish slavery?

Had Europe not decided to end the slave trade and the New World ceased demanding chattel labour, the transatlantic trade might still be rolling today. The ending of the obnoxious business had nothing to do with events in Africa.

Rulers and traders there would have happily continued to sell humans for as long as there was demand for them. One can only imagine how more determinedly African merchants would have clung on to the business as goods offered by European buyers became more attractive with changes in Western technology.

How many souls would African chiefs have been prepared to trade for a television or a car?

It is a disturbing thought.

To highlight the role of the African elites in the slave trade is not to argue the obvious that they were morally depraved like the Europeans who bought slaves from them. It is to show that the corrupt leadership that undermines democracy and economic development in African countries today has a long history. The selfishness and disregard for the welfare of fellow humans manifest in the sacking of national resources by modern African leaders also motivated the pillaging of the human resources of the continent in times past.

A long history of corrupt African ruling classes.

Some African writers, seeking to maximise the culpability of Europe in the slave trade, minimise the part played by African rulers and traders or explain it as the result of white trickery. Such distortion of history may make the moral case against European imperialism seem sharper, but it does nothing to aid the understanding by Africans of a critical period of their history. African slavers acted out of their own volition and for their self interest. They took advantage of the opportunity provided by Europe to consume the products of its civilisation. The triangular slave trade was a major part in the early stages of the emergence of the international market. The role of slave-trading African ruling classes in this market is not radically different from the position of the African elite in today's global economy. They both traded the resources of their people for their own gratification and prosperity. In the process they helped to weaken their nations and dim their prospects for economic and social development.

The slave trade had a profound economic, social, cultural and psychological impact on African societies and peoples. It did more to undermine African development than the colonialism that followed it. Through the trade the continent lost a large proportion of its young and able bodied population. Guyanese historian Walter Rodney cites in his book 'How Europe Underdeveloped Africa' one estimate showing that while Europe's population more than quadrupled between 1650 and 1900, Africa's population rose only by 20 per cent during the same period. The loss of work-force was not more serious than the damage to the social and economic fabric of the society and the undermining of the confidence of Africans in their historical evolution.

The transatlantic slave trade and slavery were major elements in the emergence of capitalism in the West. As Karl Marx noted, they were as pivotal to western industrialisation as the new machinery and financial systems. Slavery gave value to the colonies in the New World which were crucial in the development of international trade. Trinidadian historian Eric Williams showed in his well-researched book *Capitalism and Slavery*, that the slave trade and slavery helped to make England the workshop of the world. Profit from slave-worked colonies and the slave trade were major sources of capital accumulation which helped finance the industrial revolution. The transportation of slave transformed British seaport areas into booming centres. One Englishman calling himself 'A Genuine "Dicky Sam"', had no doubt about the link between the slave trade and prosperity of



William Wilberforce

On Friday July 26th 1833 as he lay on his deathbed Wilberforce exclaimed: "Thank God that I have lived to witness the day in which England is willing to give £20 million for the abolishment of slavery." (What would that be worth today ?)

He died three days later.

The Slavery Abolition Bill 1833 passed through the House of Lords, it received the Royal Assent (which means it became law) on 29 August 1833 and came into force on 1 August 1834. On that date slavery was abolished throughout the vast British Empire.

The Act automatically applied as new possessions (principally in Africa) subsequently became part of the British Empire.

To know who rules over you. Simply find out who it is that you are not allowed to criticise.Voltaire

We, as White people, have been GAGGED!! Then bullied, insulted, demonised, and provoked, until we object and complain. We then get called *dirty names* like Nazi, Racist, White Extremist, etc, etc.

Our weak & corrupt Lib/Lab/Con Politicians are the problem. As of Jan 2021, the UK elections are years away. Check out Populism, and Nationalism ASAP. Become "WHITE WOKE" & Push Back.

Do it today, NOW!

seaport city of Liverpool. "Like the magical wand, the traffic worked wonders; once poor, now rich; once ignoble, now great. Churches have been built and grand legacies bequeathed to all sorts of charities."

Europeans built empires, Africans drunk gin.

While Europe invested profits from the trade in laying the foundation of a powerful economic empire, African kings and traders were content with wearing used caps and admiring themselves in worthless mirrors while swigging adulterated brandy bought with the freedom of their kinsmen. Virtually all the items imported during the nefarious business were for consumption or weapons for waging wars. A slave ship's manifest published in 1665 listed items carried for sale to Africans as old hats, caps, salt, swords, knives, axe-heads, hammers, belts, sheepskin gloves, bracelets, iron jugs and even "cats to catch their mice." One African trader calling himself Grandy King George was quite specific in his demand. He wrote to a slave captain: "send me one lucking-glass, six foot long by six foot wide." He also asked for an armchair, a gold mounted cane and a stool." The more common imports were alcohol, guns and gunpowder, salt and textiles. The quality of the items shipped to Africa was inferior - the spirits were adulterated and the guns designed for the African market.

Africa's contemporary history may have been different had its rulers and traders demanded capital goods for use in building the economy rather than trinkets and booze. As it was, the slave trade arrested economic development in Africa. The loss in human resources had dire consequences for labour dependent agricultural economies. Any possibility that the internal dynamics of African society could have led to the development of capitalism and industrialisation was blocked by the slave trade. The few existing manufacturing activities were either destroyed or denied conditions for growth. Cheap European textiles, for instance, undermined local cloth production. Samuel Johnson wrote in the late nineteenth century about Yorubaland: "Before the period of intercourse with Europeans, all articles made of iron and steel, from weapons of war to pins and needles, were of home manufacture; but the cheaper and more finished articles of European make, especially cutlery, though less durable are fast displacing home-made wares." The predominance of the slave trade prevented the emergence of business classes that could have spearheaded the internal exploitation of the resources of their societies. The slave trade drew African societies into the international economy but as fodder for western economic development.

Africa devastated by slave trade wars.

Inter-communal wars waged to procure slaves were intensely destructive of human lives.

Tens of thousands of people were slaughtered in a single skirmish.

The wars and rampant kidnappings fuelled hostility and suspicion between communities. Distrust was a basic requirement for individual and communal survival. The slave trade arrested and distorted the cultural development of African societies. It affected the meaning people gave to the world and their place within it. Increased uncertainty of life gave added force to superstitious beliefs and customs. People sought salvation and protection from the spiritual world. They paid homage to gods to safeguard themselves and their families from misfortune. The psychological impact of the dehumanising trade was crippling. There was constant anxiety caused by perpetual fear of being captured and herded away like common animals to a place of no return. Some Africans believed that whites took slaves to eat them.

Whites assert racial superiority.

It was during the slave trade and slavery that white people affirmed their superiority over blacks. It is not difficult to understand why white traders who bought black people for price of adulterated brandy and packed them onto slave ships like cattle could consider themselves to be superior. Though most were illiterate, crude and drunken, white slave traders were free men herding flocks of human cattle. As the centuries passed Europeans became more and more scornful of black people. By the nineteenth century various theories of black inferiority were developed and used to justify the colonisation of Africa. During the slave trade Africans came to believe themselves to be inferior. They lost confidence in themselves, their culture and their ability to development. The late Afro-American civil rights leader Martin Luther King's comment that few people realise the extent that slavery had "scarred the soul and wounded the spirit of the black man," holds true not only with respect to the descendants of the Africans who arrived in the New World but also the descendants of those left behind. "The backwardness of black Africa," said the late Senegalese president Leopold Senghor, "...has been caused less by colonialism than by the Slave Trade."

Would the history of Africa have been turned out differently had it's leaders taken the advice of eighteenth century French thinker Jean Jacques Rousseau. He said: "If I were chief of one of the African peoples, I declare that I would have a gallows set up at the frontier, on which I would hang, without mercy, the first European who dared enter the country, and the first citizen who tried to leave it." Perhaps if more African rulers had militarily resisted the design of the better armed Europeans their peoples might have paid a bloody price, as did the Indians in the Americas who fought to keep their lands and expel the white intruders. Before Columbus arrived in Hispanoila in 1492, the native population of North America was perhaps 40 million. By 1900, in the U.S. less than quarter of a million remained, scattered among 1,500 remote reservations.

Africa's underdevelopment was not inevitable

Would Africans have suffered the same genocide had they tried to end the slave trade? Unlikely. It is doubtful that the human cost of resistance would have been

greater than the many millions of Africans killed in slave producing wars as well as those eaten by sharks after being jettisoned during the Atlantic crossings. We cannot know for certain. It seems more likely that Europe would have had to look elsewhere for cheap labour. It was one thing for European nations to use military might to protect their coastal trading posts and subdue disgruntled local chiefs, it would have been an entirely different matter for them to penetrate the interior of the continent and fight the hundreds of war that fed the slave trade.

The cost of such ventures would have made the price of slaves unattractive to the plantation owners in the Americas. As the historian Philip Curtin noted " If the prices of African-born slaves had not been competitive with those of labour from other sources - native born or European - the slave trade could never have come into existence, no matter what the epidemiological consequences of movement across the Atlantic."

Had cheap Africans not been available to work the land and mines of the 'New World', white planters and landowners would have sought other sources of cheap labour. They would have made more use of the native population and also turned more to Europe for labour. In the seventeenth and eighteenth centuries large numbers of poor whites were shipped to the 'New World', most involuntarily, to work on plantations, mines and as servants. Some poor whites kidnapped on European streets were sold in the West Indies much in the same way as Africans were. Indentured servants, convicts and deportees from Europe were often treated not much better than black slaves. But as the transatlantic slave trade boomed, the number of whites in forced labour decreased. It was because of the relative cheapness of African slave labour, and therefore the plantation owners' preference for them, that the trade in white labour ended. This gave rise to what Afro-American writer William DuBois described as the replacement of "a caste of condition by a caste of race." Had the costs of black slaves been much dearer, Europe might have become a major source of unfree labour.

Tunde Obadina is director of Africa Business Information Services



RACIST BRITAIN?

In 1833, Britain used 40% of its national budget to **buy freedom for all slaves** in the Empire. Britain borrowed such a large sum of money for the Slavery Abolition Act that it **wasn't paid off until 2015**. This means that **living British citizens** helped pay for the ending of the slave trade with their taxes.

LEAVE.EU



William Wilberforce
On Friday July 26th 1833 as he lay on his deathbed Wilberforce exclaimed: "Thank God that I have lived to witness the day in which England is willing to give £20 million for the abolishment of slavery." (What would that be worth today ?)
He died three days later.

The Slavery Abolition Bill 1833 passed through the House of Lords, it received the Royal Assent (which means it became law) on 29 August 1833 and came into force on 1 August 1834. On that date slavery was abolished throughout the vast British Empire. The Act automatically applied as new possessions (principally in Africa) subsequently became part of the British Empire.

To know who rules over you. Simply find out who it is that you are not allowed to criticise.Voltaire

We, as White people, have been GAGGED!! Then bullied, insulted, demonised, and provoked, until we object and complain. We then get called *dirty names* like Nazi, Racist, White Extremist, etc, etc.

Our weak & corrupt Lib/Lab/Con Politicians are the problem. As of Jan 2021, the UK elections are years away. Check out Populism, and Nationalism ASAP. Become "WHITE WOKE" & Push Back.

Do it today, NOW!

African Chiefs Urged To Apologise For Slave Trade

"We cannot continue to blame the white men, as Africans, particularly the traditional rulers, are not blameless."

From <https://www.theguardian.com>

African chiefs urged to apologise for slave trade

Nigerian civil rights group says tribal leaders' ancestors sold people to slavers and should say sorry like US and Britain.

Traditional African rulers whose ancestors collaborated with European and Arab slave traders should follow Britain and the United States by publicly saying sorry, according to human rights organisations.

The Civil Rights Congress of Nigeria has written to tribal chiefs saying: "We cannot continue to blame the white men, as Africans, particularly the traditional rulers, are not blameless."

The appeal has reopened a sensitive debate over the part some chiefs played in helping to capture their fellow Africans and sell them into bondage as part of the transatlantic slave trade. The congress argued that the ancestors of the chiefs had helped to raid and kidnap defenceless communities and traded them to Europeans.

They should now apologise to "put a final seal to the history of slave trade", it said. "In view of the fact that the Americans and Europe have accepted the cruelty of their roles and have forcefully apologised, it would be logical, reasonable and humbling if African traditional rulers ... [can] accept blame and formally apologise to the descendants of the victims of their collaborative and exploitative slave trade."

Estimates vary that between 10 million and 28 million Africans were sent to the Americas and sold into slavery between 1450 and the early 19th century. More than a million are believed to have died in transit across the so-called "middle passage" of the Atlantic due to inhumane conditions aboard slave ships and the brutal crushing of any resistance. Three years ago Tony Blair described Britain's participation as a "crime against humanity" and expressed his "deep sorrow". The US Senate voted for an apology this year.

Shehu Sani, head of the congress, said it was calling for traditional rulers to apologise now because they were seeking inclusion in a forthcoming constitutional amendment in Nigeria. "We felt that for them to have the moral standing to be part of our constitutional arrangement there are some historical issues for them to address," he told the BBC World Service. "One part of which is the involvement of their institutions in the slave trade." He said that on behalf of the buyers of slaves, the ancestors of the traditional rulers "raided communities and kidnapped people,

shipping them away across the Sahara or across the Atlantic".

Many slaves captured inland in Africa died on the long journey to the coast.

The position was endorsed by Henry Bonsu, a British-born broadcaster of Ghanaian descent who examined the issue in Ghana for a radio documentary. He said some chiefs had accepted responsibility and sought atonement by visiting Liverpool and the United States. "I interviewed a chief who acknowledged there was collaboration and that without that involvement we wouldn't have seen human trafficking on an industrial scale," said Bonsu, the co-founder of digital station Colourful Radio. "An apology in Nigeria might be helpful because the chiefs did some terrible things and abetted a major crime."

The non-government organisation Africa Human Right Heritage, based in Accra, Ghana, supports the campaign for an apology. Baffour Anning, its chief executive, said: "I certainly agree with the Nigeria Civil Rights Congress that the traditional leaders should render an apology for their role in the inhuman slavery administration." He said it would accord with the UN's position on human rights. But the issue was not a high priority for most African citizens, according to Bonsu. "In my experience it's mainly the African diaspora who want an apology. People aren't milling around Lagos or Accra moaning about why chiefs don't apologise. They are more concerned about the everyday and why they still have bad governance."

Fred Swaniker, the founder of the African Leadership Academy, said: "I'm not sure whether an apology is needed, but it would be worth looking at and acknowledging the role Africa did play in the slave trade. Someone had to find the slaves and bring them before the Europeans."

The shameful history of some traditional leaders remains an awkward subject on which many politicians prefer to maintain silence. One exception was in 1998 when Yoweri Museveni, the president of Uganda, told an audience including Bill Clinton: "African chiefs were the ones waging war on each other and capturing their own people and selling them. If anyone should apologise it should be the African chiefs. We still have those traitors here even today."

Marxist Generals - Ethnic Soldiers - White Victims - Worldwide



William Wilberforce

On Friday July 26th 1833 as he lay on his deathbed Wilberforce exclaimed: "Thank God that I have lived to witness the day in which England is willing to give £20 million for the abolishment of slavery." (What would that be worth today ?) He died three days later.

The Slavery Abolition Bill 1833 passed through the House of Lords, it received the Royal Assent (which means it became law) on 29 August 1833 and came into force on 1 August 1834. On that date slavery was abolished throughout the vast British Empire. The Act automatically applied as new possessions (principally in Africa) subsequently became part of the British Empire.

To know who rules over you. Simply find out who it is that you are not allowed to criticise.Voltaire

We, as White people, have been GAGGED!! Then bullied, insulted, demonised, and provoked, until we object and complain. We then get called *dirty names* like Nazi, Racist, White Extremist, etc, etc.

Our weak & corrupt Lib/Lab/Con Politicians are the problem. As of Jan 2021, the UK elections are years away. Check out Populism, and Nationalism ASAP. Become "WHITE WOKE" & Push Back. **Do it today, NOW!**

European Imperialism Ended Slavery Worldwide

The resistance put up by Africans, Asians and Arabs was monumental in defense of slavery, and lasted for more than a century.

From <http://homepage.eircom.net/~odyssey>

"The widespread revulsion which the hideous institution of slavery inspires today was largely confined to Western civilisation a century ago, and a century before that was largely confined to a portion of British society.

No one seems interested in the epic story of how this curse that covered the globe and endured for thousands of years was finally gotten rid of by the West - not only in Western societies but in other societies conquered, controlled, or pressured by the West.

The resistance put up by Africans, Asians and Arabs was monumental in defense of slavery, and lasted for more than a century. Only the overwhelming military power of the West enabled it to prevail on this issue, and only the moral outrage of Western peoples kept their government's feet to the fire politically to maintain the pressure against slavery around the world.

Of course, this is not the kind of story that appeals to the multiculturalists. If it had been the other way around - if Asian or African imperialists had stamped out slavery in Europe - it would still be celebrated, in story and song, on campuses across America."

- Thomas Sowell, "Multicultural instruction"

"Whenever I hear anyone arguing for slavery, I feel a strong impulse to see it tried on him personally."

- Abraham Lincoln

"In Africa down to the 1930's, the various tribes continued to raid one another to capture slaves both for domestic use and to sell to outsiders. Moreover, in spite of the picture presented in Alex Haley's Roots, white slave traders almost never entered the interior in pursuit of prey but rather purchased their cargo from Africans at the ocean front; coastal Africans would not allow Europeans either into or through their own countries... ..some scholars claimed that slavery in Africa was a response to the international slave trade, but it is now obvious that (Black) slavery was an old domestic institution that was adapted for supplying the

international market when it developed."

- Richard Hellie, "Slavery in Russia 1450-1725"

"Among the Tuareg of the southern Sahara, during the 19th century 70-90% of the population were probably slaves. In the Sahel and the savannah, half the population might be slaves, while in the forests the figure could be as low as 10 to 20 percent. Professor Oliver in "The African Experience" argues that the European and American demand for slaves may not have increased the supply. White slave traders almost never ventured into the interior and were dependent on a varying supply over which they had no control. They followed the flow of captives rather than create it, shifting their bases up and down the coast according to where tribal wars were producing the most slaves. Africa clung to slavery long after it was abolished elsewhere. Between the world wars, Liberia, founded by freed American slaves, was censured by the League of Nations for practising slavery."

- Thomas Jackson, 1992, American Renaissance 3, x.

Thomas Sowell in "Race and Culture" notes that, historically speaking, it was not only blacks who bore the burden of slavery. Millions of people - Europeans, Africans and Asians - have suffered the indignity of involuntary servitude. The very word "slave", he notes, is a close etymological relative of the word "Slav", and came to be used because the Slavic peoples were once a favorite prey of slave traders. To contend, therefore, that some of the uglier social difficulties commonplace within the black community are a "legacy of slavery" is unequivocal rubbish, in Sowell's view.

As he points out, before 1950, and going back over 100 years to the era of slavery, most black children were reared in two-parent homes. Black social problems are a legacy of the welfare state, Sowell asserts, not of events in past centuries and certainly not of "racism".

- James Thornton, 1995, New American 11, i.

Was slavery a racist institution? No. Slavery was practised for thousands of years in virtually all societies: in China, India, Europe, the Arab world, sub-Saharan Africa, and the Americas. In the United States, slave-holding was not confined to whites: American Indians and free blacks owned thousands of slaves. Thus slavery is neither distinctively Western nor racist. What is uniquely Western is the abolition of slavery.

- Dinesh D'Souza, "The End of Racism"

Slavery was an ugly, dirty business but people of virtually every race, color, and creed engaged in it on every inhabited continent. And the people they enslaved were also of virtually every race, color, and creed... a million Europeans were enslaved by North Africans between 1500 and 1800. Europeans enslaved other Europeans for centuries before the drying up of that supply led them to turn to Africa as a source of slaves for the Western Hemisphere.

- Thomas Sowell

On the issue of slavery, it was essentially Western civilization against the world. What was peculiar about the West was not that it participated in the worldwide evil of slavery, but that it later abolished that evil... it was essentially European imperialism which ended slavery.



William Wilberforce

On Friday July 26th 1833 as he lay on his deathbed Wilberforce exclaimed: "Thank God that I have lived to witness the day in which England is willing to give £20 million for the abolishment of slavery." (What would that be worth today ?) He died three days later.

The Slavery Abolition Bill 1833 passed through the House of Lords, it received the Royal Assent (which means it became law) on 29 August 1833 and came into force on 1 August 1834. On that date slavery was abolished throughout the vast British Empire. The Act automatically applied as new possessions (principally in Africa) subsequently became part of the British Empire.

To know who rules over you. Simply find out who it is that you are not allowed to criticise.Voltaire

We, as White people, have been GAGGED!! Then bullied, insulted, demonised, and provoked, until we object and complain. We then get called *dirty names* like Nazi, Racist, White Extremist, etc, etc.

Our weak & corrupt Lib/Lab/Con Politicians are the problem. As of Jan 2021, the UK elections are years away. Check out Populism, and Nationalism ASAP. Become "WHITE WOKE" & Push Back.

Do it today, NOW!

- Thomas Sowell, "Black Rednecks and White Liberals"

African kings were glad to provide a steady flow of men, women and children, who they said were criminals or prisoners of war doomed for execution. Many were not, but this did not prevent partisans of the trade from posing as philanthropists who were rescuing the Africans from death and offering them a better and, of course, more productive life. An African chief, dismayed by the news that the slave trade was on the verge of abolition, insisted that his "oracle and priests" had told him that their god wholeheartedly approved of it. The Christian and Muslim gods agreed, or so their clerics proclaimed.

- Lawrence James, reviewing Hugh Thomas' "The Slave Trade"

The vogue of repudiating black family names that supposedly were given by slaveowners in times past is another reflection of the widespread ignorance of history among Americans in general, as a result of our dumbed-down education. Slaves were not only not given family names, they were forbidden to have family names.

Slaveowners in the American antebellum South were especially opposed to slaves having family names because such names emphasized family ties - and the only legally recognized tie of a slave was to his owner, who could sell him miles away from his kin. The slaves themselves, however, used family names to create a sense of family, though they were careful not to use these names around whites.

- Thomas Sowell, "Naming Names"

It was Al Gore who, in an election campaign attack on Bush's alleged judicial preferences, repeated the libel claiming that the framers of the Constitution regarded a black person as 'three-fifths of a human being'. This is one of the most widely believed myths in black America today. In fact, it was not 'blacks' as such, who were so designated but slaves, there were thousands of free blacks, and it was the anti-slavery Framers who insisted on the three-fifths figure in order to diminish the electoral power of the slave South.

- David Horowitz, "Bush's Political Lynching", Salon.Com

"If great improvements are seldom to be expected from great proprietors, they are least of all to be expected when they employ slaves for their workmen. The experience of all ages and nations, I believe, demonstrates that the work done by slaves, though it appears to cost only their maintenance, is in the end the dearest of any. A person who can acquire no property, can have no other interest but to eat as much, and to labour as little as possible. Whatever work he does beyond what is sufficient to purchase his own maintenance can be squeezed out of him by violence only... the pride of man makes him love to domineer, and nothing mortifies him so much as to be obliged to condescend to persuade his inferiors. Wherever the law allows it, and the nature of the work can afford it, therefore, he will generally prefer the service of slaves to that of freemen."

- Adam Smith, "The Wealth of Nations" (1776)

The anti-slavery movement was spearheaded by people who would today be called "the religious right" and its organization was created by conservative businessmen. Moreover, what destroyed slavery in the non-Western world was Western imperialism. Nothing could be more jolting and discordant with the vision of today's intellectuals than the fact that it was businessmen, devout religious leaders and Western imperialists who together destroyed slavery around the world. And if it doesn't fit their vision, it is the same to them as if it never happened.

- Thomas Sowell

Since the 1960s, it has been fashionable in some quarters to take cheap shots at Lincoln, asking such questions as "Why didn't he free all the slaves?" "Why did he wait so long?" "How come the Emancipation Proclamation didn't just come right out and say that slavery was wrong?"

People who indulge themselves in this kind of self-righteous carping act as if Lincoln was someone who could do whatever he damn well pleased, without regard to the law, the Congress, or the Supreme Court. Just one fact should give pause to Lincoln's critics today: When Lincoln sat down to write the Emancipation Proclamation, the Supreme Court was still headed by Chief Justice Roger Taney, who had issued the infamous Dred Scott decision, saying a black man had no rights which a white man needed to respect. This was a Supreme Court that would not have hesitated to declare the freeing of slaves unconstitutional — and Lincoln knew it. There would have been no point in issuing an Emancipation Proclamation that didn't actually emancipate anybody. Ringing rhetoric about the wrongness of slavery would not have gotten the Emancipation Proclamation past Taney and his Supreme Court. Since Lincoln's purpose was to free millions of human beings, not leave some rhetoric to be preserved in the anthologies, he wrote the Emancipation Proclamation in dry legalistic terms that disappointed thoughtless critics in his time and ours, but got it past the Supreme Court. Nothing in the Constitution gave a President the authority to free slaves. The only thing Lincoln could use to make his actions legal was his authority as commander-in-chief in wartime. But that meant that he could only free the slaves in territory controlled by enemy forces. Lincoln was out on a limb, both politically and legally. He could have been impeached. At a minimum, he expected to lose the next election and was surprised when he didn't. But today we see the spectacle of pygmies sniping at this giant. As for the other slaves not covered by the Emancipation Proclamation, Lincoln worked behind the scenes to try to get slave-holding border states to emancipate them by state actions that would be beyond the jurisdiction of the U.S. Supreme Court.

- Thomas Sowell, "Trashing Our History: Lincoln"

WHITE SLAVERY

Julius Caesar enslaved as many as one million Whites from Gaul. From the eighth to the eleventh century France was a major transfer point for White slaves to the Muslim world, with Rouen being the center for the selling of Irish and Flemish



William Wilberforce

On Friday July 26th 1833 as he lay on his deathbed Wilberforce exclaimed: "Thank God that I have lived to witness the day in which England is willing to give £20 million for the abolishment of slavery." (What would that be worth today ?) He died three days later.

The Slavery Abolition Bill 1833 passed through the House of Lords, it received the Royal Assent (which means it became law) on 29 August 1833 and came into force on 1 August 1834. On that date slavery was abolished throughout the vast British Empire. The Act automatically applied as new possessions (principally in Africa) subsequently became part of the British Empire.

To know who rules over you. Simply find out who it is that you are not allowed to criticise.Voltaire

We, as White people, have been GAGGED!! Then bullied, insulted, demonised, and provoked, until we object and complain. We then get called *dirty names* like Nazi, Racist, White Extremist, etc, etc.

Our weak & corrupt Lib/Lab/Con Politicians are the problem. As of Jan 2021, the UK elections are years away. Check out Populism, and Nationalism ASAP. Become "WHITE WOKE" & Push Back.

Do it today, NOW!



William Wilberforce

On Friday July 26th 1833 as he lay on his deathbed Wilberforce exclaimed: "Thank God that I have lived to witness the day in which England is willing to give £20 million for the abolishment of slavery." (What would that be worth today ?) He died three days later.

The Slavery Abolition Bill 1833 passed through the House of Lords, it received the Royal Assent (which means it became law) on 29 August 1833 and came into force on 1 August 1834. On that date slavery was abolished throughout the vast British Empire. The Act automatically applied as new possessions (principally in Africa) subsequently became part of the British Empire.

To know who rules over you. Simply find out who it is that you are not allowed to criticise.Voltaire

We, as White people, have been GAGGED!! Then bullied, insulted, demonised, and provoked, until we object and complain. We then get called *dirty names* like Nazi, Racist, White Extremist, etc, etc.

Our weak & corrupt Lib/Lab/Con Politicians are the problem. As of Jan 2021, the UK elections are years away. Check out Populism, and Nationalism ASAP. Become "WHITE WOKE" & Push Back.

Do it today, NOW!

member of the perpetrator's racial group.

The only alternative to this kind of racial balkanization is to reject the notion of racial collectivism altogether and embrace the opposite principle: individualism. People should be judged based on their choices, ideas, and actions as individuals, not as "representatives" of a racial group. They should be rewarded based on their own merits-and they must not be forced to pay, or to apologize, for crimes committed by others, merely because those others have the same skin color. Americans, both black and white, should reject the notion of a collective guilt for slavery. They should uphold the ideal of a color-blind society, based on individualism, as the real answer to racism.

- Robert W. Tracinski, "Apology for Slavery Will Perpetuate Racism"

What no one in their delegations (to the Durban Racism Conference" will say is this - that the West has nothing to apologize or pay for, least of all Britain. London abolished slavery in the British Isles in 1772 and within the Empire in 1833, in the teeth of fierce opposition from Arab and West African traders. If one had to single out one institution that did more to end the trade in human beings than any other, it would be the Royal Navy, whose ships enforced the ban at great risk to themselves. Yet the reflexive shame in their inheritance is such that no British, or Canadian, delegate in Durban would dream of standing up for the historical record.

- Mark Steyn, "The World Conference Against Whitey"

"Think about it: we went into slavery pagans; we came out Christians. We went into slavery pieces of property; we came out American citizens. We went into slavery with chains clanking about our wrists; we came out with the American ballot in our hands. Notwithstanding the cruelty and moral wrong of slavery, we are in a stronger and more hopeful condition, materially, intellectually, morally and religiously, than is true of an equal number of black people in any other portion of the globe."

- Booker T. Washington, "Selected Speeches" (1932)

"My ancestors who lived and died in slavery are dead. The white men who profited by their labor and lives are dead also. I have no personal memory of those times and no responsibility for them. Neither has the grandson of the man who held my folks... I have no intention of wasting my time beating on old graves. I do not belong to the sobbing school of Negroes who hold that nature somehow has given them a low down dirty deal and whose feelings are all hurt about it... Slavery is the price I paid for civilization, and that is worth all that I have paid through my ancestors for it.

- Zora Neale Hurston

In the nineteenth century, when France and Britain outlawed slavery in their territories, African chiefs who had grown fat on the slave trade sent protest delegations to Paris and London. As Dinesh D'Souza in "The End of Racism"

slaves. At the same time Venetians were selling slaves and timber across the Mediterranean. The slaves were usually Slavs brought across the Alps. From 1609 until the early 1800's, between one half and two thirds of all the White colonists who came to the New World came as slaves. Of the passengers on the Mayflower, twelve were White slaves. White slaves cleared the forests, drained the swamps, built the roads. They worked and died in greater numbers than anyone else.

In Barbados by the 1640's there were an estimated 25,000 slaves, of whom 21,700 were White. Cromwell's conquest of Ireland in the middle of the seventeenth century made slaves as well as subjects of the Irish people. Over a hundred thousand men, women and children were seized by the English troops and shipped to the West Indies, where they were sold into slavery. In the British West Indies the torture visited upon White slaves by their masters was routine. Masters hung White slaves by their hands and set their hands afire as a means of punishment.

To end this barbarity, Colonel William Brayne wrote to English authorities in 1656 urging the importation of negro slaves on the grounds that, "as the planters would have to pay much for them, they would have an interest in preserving their lives, which was wanting in the case of whites.", many of whom, he charged, were killed by overwork and cruel treatment. Ten thousand Whites were kidnapped from England in the year 1670 alone.

- M.A. Hoffman, "They Were White and They Were Slaves"

"Hope, the best comfort of our imperfect condition, was not denied to the Roman slave; and if he had any opportunity of rendering himself either useful or agreeable, he might very naturally expect that the diligence and fidelity of a few years would be rewarded with the inestimable gift of freedom."

- Edward Gibbon, "The Decline and Fall of the Roman Empire", 1776.

APOLOGIES

An apology for slavery on behalf of the American nation presumes that whites today, who predominantly oppose racism, and never owned slaves, and who bear no personal responsibility for slavery, still bear a collective responsibility-a guilt they bear simply by belonging to the same race as the slave-holders of the Old South. Such an apology promotes the very idea at the root of slavery: racial collectivism.

Those who owned slaves were certainly guilty of a grave injustice. But by what standards can other whites (many of whom are not even descendants of the slave-holders) be held responsible for their ideas and actions? The only justification for such an approach is the idea that each member of the race can be blamed for the actions of every other member, that we are all just interchangeable cells of the racial collective.

The ultimate result of this approach is not racial harmony or a color-blind society, but racial warfare. Under the premise of racial collectivism, an injustice committed against any member of your racial group entitles you to retaliate against any

explains, Africans never developed a principled opposition to slavery; they denounced it when they were slaves but practised it happily when they could. Slavery can still be found in Africa. In America too, by 1830, some 3,500 free blacks in the South owned approximately 10,000 slaves.

D'Souza finds that in North America "slaves were, in material terms of diet, health and shelter, slightly better off than northern industrial workers, and far better off than workers in much of Europe." As he points out, "no free workers enjoyed a comparable social security system from birth until death." Moreover, life expectancy for slaves was only slightly lower than that of their owners. When slave owners had really dangerous work to do, they hired Irish navvies rather than risk their valuable property." On balance, says Mr D'Souza, whites owe blacks nothing on account of slavery.

- Thomas Jackson, 1995, American Renaissance, xi.

"In Brazil slavery was never as widespread as in the United States, and race relations are consistently described as better than they are in the US, yet the disparity between black and white incomes is greater in Brazil than in the US. Cuba also has a mixed population and is famous for its aggressive, socialist egalitarianism. Though Cuban officials are embarrassed by this and try to keep it a secret, blacks are invariably at the bottom of society.

The Caribbean nation of Haiti presents an interesting parallel to the failures of black Africans. Its six million inhabitants are all black, the descendants of slaves. Haiti has essentially been governed by blacks ever since the slave insurrection of 1791, in which nearly all whites were killed. Thus it has a history of independence and black rule that is much longer than that of African nations. Despite such different histories, Haiti is practically indistinguishable from Africa in terms of GNP per caput, infant mortality rates, average educational level, and all the other indices of modernization. Its governments have been the corrupt shambles that is typical of Africa. If Haiti were dragged across the Atlantic Ocean and attached to the coast of Africa, it would seem perfectly at home."



William Wilberforce

On Friday July 26th 1833 as he lay on his deathbed Wilberforce exclaimed: "Thank God that I have lived to witness the day in which England is willing to give £20 million for the abolishment of slavery." (What would that be worth today ?)

He died three days later.

The Slavery Abolition Bill 1833 passed through the House of Lords, it received the Royal Assent (which means it became law) on 29 August 1833 and came into force on 1 August 1834. On that date slavery was abolished throughout the vast British Empire.

The Act automatically applied as new possessions (principally in Africa) subsequently became part of the British Empire.

To know who rules over you. Simply find out who it is that you are not allowed to criticise.Voltaire

We, as White people, have been GAGGED!! Then bullied, insulted, demonised, and provoked, until we object and complain. We then get called *dirty names* like Nazi, Racist, White Extremist, etc, etc.

Our weak & corrupt Lib/Lab/Con Politicians are the problem. As of Jan 2021, the UK elections are years away. Check out Populism, and Nationalism ASAP. Become "WHITE WOKE" & Push Back.

Do it today, NOW!

Dixies Censored Subject: Black Slave Owners



William Wilberforce

On Friday July 26th 1833 as he lay on his deathbed Wilberforce exclaimed: "Thank God that I have lived to witness the day in which England is willing to give £20 million for the abolishment of slavery." (What would that be worth today?)

He died three days later.

The Slavery Abolition Bill 1833 passed through the House of Lords, it received the Royal Assent (which means it became law) on 29 August 1833 and came into force on 1 August 1834. On that date slavery was abolished throughout the vast British Empire.

The Act automatically applied as new possessions (principally in Africa) subsequently became part of the British Empire.

To know who rules over you. Simply find out who it is that you are not allowed to criticise.Voltaire

We, as White people, have been GAGGED!! Then bullied, insulted, demonised, and provoked, until we object and complain. We then get called *dirty names* like Nazi, Racist, White Extremist, etc, etc.

Our weak & corrupt Lib/Lab/Con Politicians are the problem. As of Jan 2021, the UK elections are years away. Check out Populism, and Nationalism ASAP. Become "WHITE WOKE" & Push Back.

Do it today, NOW!

In 1860 there were at least six Negroes in Louisiana who owned 65 or more slaves. The largest number, 152 slaves, were owned by the widow C. Richards and her son P.C. Richards, who owned a large sugar cane plantation. Another Negro slave magnate in Louisiana, with over 100 slaves, was Antoine Dubuclet, a sugar planter whose estate was valued at (in 1860 dollars) \$264,000 (3). That year, the mean wealth of southern white men was \$3,978 (4).

In Charleston, South Carolina in 1860 125 free Negroes owned slaves; six of them owning 10 or more. Of the \$1.5 million in taxable property owned by free Negroes in Charleston, more than \$300,000 represented slave holdings (5). In North Carolina 69 free Negroes were slave owners (6).

In 1860 William Ellison was South Carolina's largest Negro slaveowner. In *Black Masters. A Free Family of Color in the Old South*, authors Michael P. Johnson and James L. Roak write a sympathetic account of Ellison's life. From Ellison's birth as a slave to his death at 71, the authors attempt to provide justification, based on their own speculation, as to why a former slave would become a magnate slave master.

At birth he was given the name April. A common practice among slaves of the period was to name a child after the day or month of his or her birth. Between 1800 and 1802 April was purchased by a white slave-owner named William Ellison. Apprenticed at 12, he was taught the trades of carpentry, blacksmithing and machining, as well as how to read, write, cipher and do basic bookkeeping.

On June 8, 1816, William Ellison appeared before a magistrate (with five local freeholders as supporting witnesses) to gain permission to free April, now 26 years of age. In 1800 the South Carolina legislature had set out in detail the procedures for manumission. To end the practice of freeing unruly slaves of "bad or depraved" character and those who "from age or infirmity" were incapacitated, the state required that an owner testify under oath to the good character of the slave he sought to free. Also required was evidence of the slave's "ability to gain a livelihood in an honest way."

Although lawmakers of the time could not envision the incredibly vast public welfare structures of a later age, these stipulations became law in order to prevent slaveholders from freeing individuals who would become a burden on the general public.

Interestingly, considering today's accounts of life under slavery, authors Johnson and Roak report instances where free Negroes petitioned to be allowed to become slaves; this because they were unable to support themselves.

Black Confederates and Afro-Yankees in Civil War Virginia (University Press of Virginia-1995) was written by Ervin L. Jordan Jr., an African-American and assistant professor and associate curator of the Special Collections Department, University of Virginia library. He wrote: "One of the more curious aspects of the free black existence in Virginia was their ownership of slaves. Black slave masters owned members of their family and freed them in their wills. Free blacks were encouraged to sell themselves into slavery and had the right to choose their owner through a lengthy court procedure."

In 1816, shortly after his manumission, April moved to Stateburg. Initially he hired

Dixie's censored subject: Black Slave Owners By Robert M. Grooms

From http://americancivilwar.com/authors/black_slaveowners.htm

In an 1856 letter to his wife Mary Custis Lee, Robert E. Lee called slavery "a moral and political evil." Yet he concluded that black slaves were immeasurably better off here than in Africa, morally, socially and physically.

The fact is large numbers of free Negroes owned black slaves; in fact, in numbers disproportionate to their representation in society at large. In 1860 only a small minority of whites owned slaves. According to the U.S. census report for that last year before the Civil War, there were nearly 27 million whites in the country. Some eight million of them lived in the slaveholding states.

The census also determined that there were fewer than 385,000 individuals who owned slaves (1). Even if all slaveholders had been white, that would amount to only 1.4 percent of whites in the country (or 4.8 percent of southern whites owning one or more slaves).

In the rare instances when the ownership of slaves by free Negroes is acknowledged in the history books, justification centers on the claim that black slave masters were simply individuals who purchased the freedom of a spouse or child from a white slaveholder and had been unable to legally manumit them. Although this did indeed happen at times, it is a misrepresentation of the majority of instances, one which is debunked by records of the period on blacks who owned slaves. These include individuals such as Justus Angel and Mistress L. Horry, of Colleton District, South Carolina, who each owned 84 slaves in 1830. In fact, in 1830 a fourth of the free Negro slave masters in South Carolina owned 10 or more slaves; eight owning 30 or more (2). According to federal census reports, on June 1, 1860 there were nearly 4.5 million Negroes in the United States, with fewer than four million of them living in the southern slaveholding states. Of the blacks residing in the South, 261,988 were not slaves. Of this number, 10,689 lived in New Orleans. The country's leading African American historian, Duke University professor John Hope Franklin, records that in New Orleans over 3,000 free Negroes owned slaves, or 28 percent of the free Negroes in that city.

To return to the census figures quoted above, this 28 percent is certainly impressive when compared to less than 1.4 percent of all American whites and less than 4.8 percent of southern whites. The statistics show that, when free, blacks disproportionately became slave masters. The majority of slaveholders, white and black, owned only one to five slaves. More often than not, and contrary to a century and a half of bullwhips-on-tortured-backs propaganda, black and white masters worked and ate alongside their charges; be it in house, field or workshop. The few individuals who owned 50 or more slaves were confined to the top one percent, and have been defined as slave magnates.



William Wilberforce

On Friday July 26th 1833 as he lay on his deathbed Wilberforce exclaimed: "Thank God that I have lived to witness the day in which England is willing to give £20 million for the abolishment of slavery." (What would that be worth today ?) He died three days later.

The Slavery Abolition Bill 1833 passed through the House of Lords, it received the Royal Assent (which means it became law) on 29 August 1833 and came into force on 1 August 1834. On that date slavery was abolished throughout the vast British Empire. The Act automatically applied as new possessions (principally in Africa) subsequently became part of the British Empire.

To know who rules over you. Simply find out who it is that you are not allowed to criticise.Voltaire

We, as White people, have been GAGGED!! Then bullied, insulted, demonised, and provoked, until we object and complain. We then get called *dirty names* like Nazi, Racist, White Extremist, etc, etc.

Our weak & corrupt Lib/Lab/Con Politicians are the problem. As of Jan 2021, the UK elections are years away. Check out Populism, and Nationalism ASAP. Become "WHITE WOKE" & Push Back.

Do it today, NOW!

slave workers from local owners. When in 1817 he built a gin for Judge Thomas Watries, he credited the judge nine dollars "for hire of carpenter George for 12 days." By 1820 he had purchased two adult males to work in his shop (7). In fewer than four years after being freed, April demonstrated that he had no problem perpetuating an institution he had been released from. He also achieved greater monetary success than most white people of the period.

On June 20, 1820, April appeared in the Sumter District courthouse in Sumterville. Described in court papers submitted by his attorney as a "freed yellow man of about 29 years of age," he requested a name change because it "would yet greatly advance his interest as a tradesman." A new name would also "save him and his children from degradation and contempt which the minds of some do and will attach to the name April." Because "of the kindness" of his former master and as a "Mark of gratitude and respect for him" April asked that his name be changed to William Ellison. His request was granted.

In time the black Ellison family joined the predominantly white Episcopalian church. On August 6, 1824 he was allowed to put a family bench on the first floor, among those of the wealthy white families. Other blacks, free and slave, and poor whites sat in the balcony. Another wealthy Negro family would later join the first floor worshippers.

Between 1822 and the mid-1840s, Ellison gradually built a small empire, acquiring slaves in increasing numbers. He became one of South Carolina's major cotton gin manufacturers, selling his machines as far away as Mississippi. From February 1817 until the War Between the States commenced, his business advertisements appeared regularly in newspapers across the state. These included the Camden Gazette, the Sumter Southern Whig and the Black River Watchman.

Ellison was so successful, due to his utilization of cheap slave labor, that many white competitors went out of business. Such situations discredit impressions that whites dealt only with other whites. Where money was involved, it was apparent that neither Ellison's race or former status were considerations.

In his book, Ervin L. Jordan Jr. writes that, as the great conflagration of 1861-1865 approached: "Free Afro-Virginians were a nascent black middle class under siege, but several acquired property before and during the war. Approximately 169 free blacks owned 145,976 acres in the counties of Amelia, Amherst, Isle of Wight, Nansemond, Prince William and Surry, averaging 870 acres each. Twenty-rune Petersburg blacks each owned property worth \$1,000 and continued to purchase more despite the war."

Jordan offers an example: "Gilbert Hunt, a Richmond ex-slave blacksmith, owned two slaves, a house valued at \$1,376, and \$500 in other properties at his death in 1863." Jordan wrote that "some free black residents of Hampton and Norfolk owned property of considerable value; 17 black Hamptonians possessed property worth a total of \$15,000. Thirty-six black men paid taxes as heads of families in

Elizabeth City County and were employed as blacksmiths, bricklayers, fishermen, oystermen and day laborers. In three Norfolk County parishes 160 blacks owned a total of \$41,158 in real estate and personal property.

The general practice of the period was that plantation owners would buy seed and equipment on credit and settle their outstanding accounts when the annual cotton crop was sold. Ellison, like all free Negroes, could resort to the courts for enforcement of the terms of contract agreements. Several times Ellison successfully sued white men for money owed him.

In 1838 Ellison purchased on time 54.5 acres adjoining his original acreage from one Stephen D. Miller. He moved into a large home on the property. What made the acquisition notable was that Miller had served in the South Carolina legislature, both in the U.S. House of Representatives and the Senate, and while a resident of Stateburg had been governor of the state. Ellison's next door neighbor was Dr. W.W. Anderson, master of "Borough House, a magnificent 18th Century mansion. Anderson's son would win fame in the War Between the States as General "Fighting Dick" Anderson.

By 1847 Ellison owned over 350 acres, and more than 900 by 1860. He raised mostly cotton, with a small acreage set aside for cultivating foodstuffs to feed his family and slaves. In 1840 he owned 30 slaves, and by 1860 he owned 63. His sons, who lived in homes on the property, owned an additional nine slaves. They were trained as gin makers by their father (8). They had spent time in Canada, where many wealthy American Negroes of the period sent their children for advanced formal education. Ellison's sons and daughters married mulattos from Charleston, bringing them to the Ellison plantation to live.

In 1860 Ellison greatly underestimated his worth to tax assessors at \$65,000. Even using this falsely stated figure, this man who had been a slave 44 years earlier had achieved great financial success. His wealth outdistanced 90 percent of his white neighbors in Sumter District. In the entire state, only five percent owned as much real estate as Ellison. His wealth was 15 times greater than that of the state's average for whites. And Ellison owned more slaves than 99 percent of the South's slaveholders.

Although a successful businessman and cotton farmer, Ellison's major source of income derived from being a "slave breeder." Slave breeding was looked upon with disgust throughout the South, and the laws of most southern states forbade the sale of slaves under the age of 12. In several states it was illegal to sell inherited slaves (9). Nevertheless, in 1840 Ellison secretly began slave breeding.

While there was subsequent investment return in raising and keeping young males, females were not productive workers in his factory or his cotton fields. As a



William Wilberforce

On Friday July 26th 1833 as he lay on his deathbed Wilberforce exclaimed: "Thank God that I have lived to witness the day in which England is willing to give £20 million for the abolishment of slavery." (What would that be worth today ?)
He died three days later.

The Slavery Abolition Bill 1833 passed through the House of Lords, it received the Royal Assent (which means it became law) on 29 August 1833 and came into force on 1 August 1834. On that date slavery was abolished throughout the vast British Empire. The Act automatically applied as new possessions (principally in Africa) subsequently became part of the British Empire.

To know who rules over you. Simply find out who it is that you are not allowed to criticise.
.....Voltaire

We, as White people, have been GAGGED!! Then bullied, insulted, demonised, and provoked, until we object and complain. We then get called *dirty names* like Nazi, Racist, White Extremist, etc, etc.

Our weak & corrupt Lib/Lab/Con Politicians are the problem. As of Jan 2021, the UK elections are years away. Check out Populism, and Nationalism ASAP. Become "WHITE WOKE" & Push Back.
Do it today, NOW!

result, except for a few females he raised to become "breeders," Ellison sold the female and many of the male children born to his female slaves at an average price of \$400. Ellison had a reputation as a harsh master. His slaves were said to be the district's worst fed and clothed. On his property was located a small, windowless building where he would chain his problem slaves.

As with the slaves of his white counterparts, occasionally Ellison's slaves ran away. The historians of Sumter District reported that from time to time Ellison advertised for the return of his runaways. On at least one occasion Ellison hired the services of a slave catcher. According to an account by Robert N. Andrews, a white man who had purchased a small hotel in Stateburg in the 1820s, Ellison hired him to run down "a valuable slave. Andrews caught the slave in Belleville, Virginia. He stated: "I was paid on returning home \$77.50 and \$74 for expenses.

William Ellison died December 5, 1861. His will stated that his estate should pass into the joint hands of his free daughter and his two surviving sons. He bequeathed \$500 to the slave daughter he had sold.

Following in their father's footsteps, the Ellison family actively supported the Confederacy throughout the war. They converted nearly their entire plantation to the production of corn, fodder, bacon, corn shucks and cotton for the Confederate armies. They paid \$5,000 in taxes during the war. They also invested more than \$9,000 in Confederate bonds, treasury notes and certificates in addition to the Confederate currency they held. At the end, all this valuable paper became worthless.

The younger Ellisons contributed more than farm produce, labor and money to the Confederate cause. On March 27, 1863 John Wilson Buckner, William Ellison's oldest grandson, enlisted in the 1st South Carolina Artillery. Buckner served in the company of Captains P.P. Galliard and A.H. Boykin, local white men who knew that Buckner was a Negro. Although it was illegal at the time for a Negro to formally join the Confederate forces, the Ellison family's prestige nullified the law in the minds of Buckner's comrades. Buckner was wounded in action on July 12, 1863. At his funeral in Stateburg in August, 1895 he was praised by his former Confederate officers as being a "faithful soldier."

Following the war the Ellison family fortune quickly dwindled. But many former Negro slave magnates quickly took advantage of circumstances and benefited by virtue of their race. For example Antoine Dubuclet, the previously mentioned New Orleans plantation owner who held more than 100 slaves, became Louisiana state treasurer during Reconstruction, a post he held from 1868 to 1877 (10).

A truer picture of the Old South, one never presented by the nation's mind molders, emerges from this account. The American South had been undergoing

structural evolutionary changes far, far greater than generations of Americans have been led to believe. In time, within a relatively short time, the obsolete and economically nonviable institution of slavery would have disappeared. The nation would have been spared awesome traumas from which it would never fully recover.

NOTES

1. **The American Negro, Raymond Logan and Irving Cohen New York: Houghton and Mifflin, 1970), p.72.**
2. **Black Masters. A Family of Color in the Old South, Michael P. Johnson and James L. Roak New York: Norton, 1984), p.64.**
3. **The Forgotten People, Gary Mills (Baton Rouge, 1977); Black Masters, p.128.**
4. **Men and Wealth in the US., 1850-1870, Lee Soltow (New Haven, 1975), p.85.**
5. **Black Masters, Appendix, Table 7; p.280.**
6. **Black Masters, p. 62.**
7. **Information on the Ellison family was obtained from Black Masters; the number of slaves they owned was gained from U.S. Census Reports.**
8. **In 1860 South Carolina had only 21 gin makers; Ellison, his three sons and a grandson account for five of the total.**
9. **Neither Black Nor White: Slaveiy and Race Relations in Brazil and the United States, Carl N. Degler (New York, Macmillan, 1971), p.39; Negro Slavery in Louisiana, Joe Gray Taylor (Baton Rouge, 1963), pp. 4041.**
10. **Reconstruction, 1863-1877, Eric Foner (New York; Harper & Row, 1988), p. 47; pp. 353-355.**



Slavery: The African Connection. Coast of Africa 1788



William Wilberforce

On Friday July 26th 1833 as he lay on his deathbed Wilberforce exclaimed: "Thank God that I have lived to witness the day in which England is willing to give £20 million for the abolishment of slavery." (What would that be worth today ?)

He died three days later.

The Slavery Abolition Bill 1833 passed through the House of Lords, it received the Royal Assent (which means it became law) on 29 August 1833 and came into force on 1 August 1834.

On that date slavery was abolished throughout the vast British Empire.

The Act automatically applied as new possessions (principally in Africa) subsequently became part of the British Empire.

To know who rules over you. Simply find out who it is that you are not allowed to criticise.Voltaire

We, as White people, have been GAGGED!! Then bullied, insulted, demonised, and provoked, until we object and complain. We then get called *dirty names* like Nazi, Racist, White Extremist, etc, etc.

Our weak & corrupt Lib/Lab/Con Politicians are the problem. As of Jan 2021, the UK elections are years away. Check out Populism, and Nationalism ASAP. Become "WHITE WOKE" & Push Back.

Do it today, NOW!

"There is great reason to believe, that most of the Negroes shipped off from the coast of Africa, are kidnapped. But the extreme care taken by the black traders to prevent the Europeans from gaining any intelligence of their modes of proceeding; the great distance inland from whence the Negroes are brought; and our ignorance of their language (with which, very frequently, the black traders themselves are equally unacquainted), prevent our obtaining such information on this head as we could wish. I have, however, by means of occasional inquiries, made through interpreters, procured some intelligence relative to the point. . . . From these I shall select the following striking instances: While I was in employ on board one of the slave ships, a Negro informed me that being one evening invited to drink with some of the black traders, upon his going away, they attempted to seize him. As he was very active, he evaded their design, and got out of their hands. He was, however, prevented from effecting his escape by a large dog, which laid hold of him, and compelled him to submit. These creatures are kept by many of the traders for that purpose; and being trained to the inhuman sport, they appear to be much pleased with it.

I was likewise told by a Negro woman that as she was on her return home, one evening, from some neighbors, to whom she had been making a visit by invitation, she was kidnapped; and, notwithstanding she was big with child, sold for a slave. This transaction happened a considerable way up the country, and she had passed through the hands of several purchasers before she reached the ship.

A man and his son, according to their own information, were seized by professed kidnappers, while they were planting yams, and sold for slaves. This likewise happened in the interior parts of the country, and after passing through several hands, they were purchased for the ship to which I belonged. It frequently happens that those who kidnap others are themselves, in their turns, seized and sold.

. . . During my stay on the coast of Africa, I was an eye-witness of the following transaction: a black trader invited a Negro, who resided a little way up the country, to come and see him. After the entertainment was over, the trader proposed to his guest, to treat him with a sight of one of the ships lying in the river. The unsuspecting countryman readily consented, and accompanied the trader in a canoe to the side of the ship, which he viewed with pleasure and astonishment. While he was thus employed, some black traders on board, who appeared to be in the secret, leaped into the canoe, seized the unfortunate man, and dragging him into the ship, immediately sold him.

The preparations made at Bonny by the black traders, upon setting out for the fairs which are held up the country, are very considerable. From twenty to thirty canoes, capable of containing thirty or forty Negroes each, are assembled for this purpose; and such goods put on board them as they expect will be wanted for the purchase of the number of slaves they intend to buy.

But the extreme care taken by the black traders to prevent the Europeans from gaining any intelligence of their modes of proceeding.

From <http://www.eyewitnesstohistory.com>

The labor-intensive agriculture of the New World demanded a large workforce. Crops such as sugar cane, tobacco and cotton required an unlimited and inexpensive supply of strong backs to assure timely production for the European market. Slaves from Africa offered the solution.

The slave trade between Western Africa and the America's reached its peak in the mid-18th century when it is estimated that over 80,000 Africans annually crossed the Atlantic to spend the rest of their lives in chains. Of those who survived the voyage, the final destination of approximately 40% was the Caribbean Islands. Thirty-eight percent ended up in Brazil, 17% in Spanish America and 6% in the United States.

It was a lucrative business. A slave purchased on the African coast for the equivalent of 14 English pounds in bartered goods in 1760 could sell for 45 pounds in the American market.

A slave's journey to a life of servitude often began in the interior of Africa with his or her capture as a prize of war, as tribute given by a weak tribal state to a more powerful one, or by outright kidnapping by local traders. European slave traders rarely ventured beyond Africa's coastal regions. The African interior was riddled with disease, the natives were often hostile and the land uncharted. The Europeans preferred to stay in the coastal region and have the natives bring the slaves to them.

"Most of the Negroes shipped off from the coast of Africa are kidnapped."

Dr. Alexander Falconbridge served as the surgeon aboard a number of slave ships that plied their trade between the West African coast and the Caribbean in the late 1700s. He described his experiences in a popular book published in 1788. He became active in the Anti-Slavery Society and was appointed Governor of a colony established for freed slaves on the coast of modern-day Sierra Leone. His service was brief as he died in 1788 shortly after his appointment. We join his story as he describes the process through which the native African loses his freedom:



When their loading is completed, they commence their voyage, with colors flying, and music playing; and in about ten or eleven days, they generally return to Bonny with full cargoes. As soon as the canoes arrive at the trader's landing place, the purchased Negroes are cleaned, and oiled with palm-oil; and on the following day they are exposed for sale to the captains.

When the Negroes, whom the black traders have to dispose of, are shown to the European purchasers, they first examine them relative to their age. They then minutely inspect their persons, and inquire into the state of their health, if they are afflicted with any infirmity, or are deformed, or have bad eyes or teeth; if they are lame, or weak in their joints, or distorted in the back, or of a slender make, or are narrow in the chest; in short, if they have been, or are afflicted in any manner, so as to render them incapable of much labor; if any of the foregoing defects are discovered in them, they are rejected. But if approved of, they are generally taken on board the ship the same evening. The purchaser has liberty to return on the following morning, but not afterwards, such as upon re-examination are found exceptionable.

The traders frequently beat those Negroes which are objected to by the captains, and use them with great severity. It matters not whether they are refused on account of age, illness, deformity, or for any other reason. At New Calabar, in particular . . . the traders, when any of their Negroes have been objected to, have dropped their canoes under the stern of the vessel, and instantly be headed them, in sight of the captain.

As soon as the wretched Africans, purchased at the fairs, fall into the hands of the black traders, they experience an earnest of those dreadful sufferings which they are doomed in future to undergo. . . . They are brought from the places where they are purchased to Bonny, etc. in canoes; at the bottom of which they lie, having their hands tied with a kind of willow twigs, and a strict watch is kept over them. Their usage in other respects, during the time of the passage, which generally lasts several days, is equally cruel. Their allowance of food is so scanty, that it is barely sufficient to support nature. They are, besides, much exposed to the violent rains which frequently fall here, being covered only with mats that afford but a slight defense; and as there is usually water at the bottom of the canoes, from their leaking, they are scarcely ever dry."

References:

This eyewitness account appears in Falconbridge, Alexander, *An Account of the Slave Trade on the Coast of Africa* (1788); Curtin, Phillip D. *Atlantic Slave Trade* (1969); Matheson, William Law, *Great Britain and the Slave Trade, 1839-1865* (1967).

How To Cite This Article:

"Slave Trade: the African Connection, ca 1788" EyeWitness to History, <http://www.eyewitnesstohistory.com> (2007).



William Wilberforce

On Friday July 26th 1833 as he lay on his deathbed Wilberforce exclaimed: "Thank God that I have lived to witness the day in which England is willing to give £20 million for the abolishment of slavery." (What would that be worth today ?)

He died three days later.

The Slavery Abolition Bill 1833 passed through the House of Lords, it received the Royal Assent (which means it became law) on 29 August 1833 and came into force on 1 August 1834. On that date slavery was abolished throughout the vast British Empire.

The Act automatically applied as new possessions (principally in Africa) subsequently became part of the British Empire.

To know who rules over you. Simply find out who it is that you are not allowed to criticise.Voltaire

We, as White people, have been GAGGED!! Then bullied, insulted, demonised, and provoked, until we object and complain. We then get called *dirty names* like Nazi, Racist, White Extremist, etc, etc.

Our weak & corrupt Lib/Lab/Con Politicians are the problem. As of Jan 2021, the UK elections are years away. Check out Populism, and Nationalism ASAP. Become "WHITE WOKE" & Push Back.

Do it today, NOW!



William Wilberforce

On Friday July 26th 1833 as he lay on his deathbed Wilberforce exclaimed: "Thank God that I have lived to witness the day in which England is willing to give £20 million for the abolishment of slavery." (What would that be worth today ?)

He died three days later.

The Slavery Abolition Bill 1833 passed through the House of Lords, it received the Royal Assent (which means it became law) on 29 August 1833 and came into force on 1 August 1834.

On that date slavery was abolished throughout the vast British Empire.

The Act automatically applied as new possessions (principally in Africa) subsequently became part of the British Empire.

To know who rules over you. Simply find out who it is that you are not allowed to criticise.Voltaire

We, as White people, have been GAGGED!! Then bullied, insulted, demonised, and provoked, until we object and complain. We then get called *dirty names* like Nazi, Racist, White Extremist, etc, etc.

Our weak & corrupt Lib/Lab/Con Politicians are the problem. As of Jan 2021, the UK elections are years away. Check out Populism, and Nationalism ASAP. Become "WHITE WOKE" & Push Back.

Do it today, NOW!

commerce of the eighteenth and nineteenth centuries. Two hundred and twenty-eight years of free labor will assure business success anywhere in the cosmos. However, the social and political dilemma for a new republic was how to justify public professions of equality, individual rights and democracy while at the same time holding fast to African captives who had been systematically and mentally dehumanized and designated as personal property. Therein lay the challenge for the founding fathers and the signers of the Declaration of Independence (1776) as well as the United States Constitution (1787). This marked the beginning of contentious race relations in America that persist to this day. False sciences and religious zealotry were the primary fervent justifications for how black slaves were treated and for the terror and brutality that flourished well into the twentieth century, decades after slavery was legally ended.

Social and political illusionists who purveyed racial inferiority, genetic deficiencies, primal instinct and infantile proclivities successfully convinced a nation that it was in fact acceptable to treat blacks as property because it was scientifically and religiously sanctioned and preordained. In reality, it was a perverted extension of manifest destiny.

On this issue, we as a nation have miles to go before we sleep

President Clinton upon leaving office in 1999 empanelled a blue ribbon committee on race; similarly in 1999, the New York Times undertook what was considered the most controversial and ambitious journalistic project in its history, How Race is Lived in America. One of the most widely anticipated Supreme Court decisions in 25 years was handed down in June 2003 concerning the propriety of race as a key consideration in college admissions policies and procedures.

If we are to progress in the global and diverse political economy of the twenty-first century, we must expand our discussions on slavery to heal our wounds of race and the malignancy of racism. In spite of its longstanding racial foibles, America is still a land of unlimited opportunity for those who are willing to be intellectually courageous enough to discount the rhetoric of the race mongers and purveyors of hate who persist in advancing agendas that alienate and polarize rather than heal and conciliate.

A more balanced discussion of slavery is a critical first step in this heretofore road not taken.

III. What Was Slavery and Why Has It Been Such a Divisive Issue Since 1865?

The greatest threat to racism in the twenty-first century is accurate and comprehensive revisionist history. History, that should begin with a documented accuracy of past events, personalities, decisions and consequences for too long has been intentionally packaged and presented so that young people will be bored and old people relieved. Two of the most important books that address this issue are Lies my Teachers Told Me: Everything Your American History Textbook Got Wrong, by James W. Loewen and Don't Know Much About History: Everything You Need to Know About History but Never Learned, by Kenneth C. Davis. Though written almost 10 years apart both begin with the same premise. Brief excerpts from each book provide the theme that surely should under-gird our revisionist History.

Davis writes:

[T]he overwhelming response of far too many Americans to history is a single

Two of the most unnecessarily divisive issues today have their genesis in slavery--reparations and the confederate flag.

From <https://academic.udayton.edu/race/02rights/slavery06a.htm>

Abraham Lincoln is hailed as the "great emancipator" because he supposedly risked his political future as well as the fragile foundation of the relatively new republic, to end slavery. This is indeed a noble version of American history and one that has inflamed and incited partisans for nearly 140 years. However, the truth, which is always relative and not absolute, is that Lincoln's one and only priority was to preserve a fragile Union that was in the throes of the Industrial Revolution and intense sectional antagonism, not to free the slaves. The political agenda was integrally intertwined with an economic agenda, both of which had far reaching international implications well beyond the purview of slavery. Unfortunately, the issue of slavery still remains the supreme bogey of American black-white race relations.

Two of the most unnecessarily divisive issues today have their genesis in slavery--reparations and the confederate flag. In an August 2, 1862 letter to Horace Greeley, Abraham Lincoln made his position on slavery crystal clear, "My paramount object in this struggle is to save the Union, and not either to save or to destroy slavery. If I could save the Union without freeing any slave, I would do it; and if I could save it by freeing all the slaves, I would do it; and if I could do it by freeing some and leave others alone, I would also do it." He was true to his words when, in September 1862, Lincoln signed the Emancipation Proclamation freeing only those slaves who were in states which were "in rebellion against the United States." Journalist Brent Staples states, "Historians working on business records are showing that the good, rich citizens of the Northeast were vigorously seeking business with Southern slavers and trafficking in slaves even after abolitionists had seized the day and Northeastern states had outlawed the slave trade." We now are beginning to see a much clearer picture of slavery and its most vital role in the emergence of 19th century America as a world economic colonial power. In the 139 years since slavery officially ended, it has continued to excite, incite and polarize America primarily because the term is inextricably attached to the issue of race. However, the ultimate irony is that in most if not all arenas of socio-political discourse, race is rapidly becoming a non-entity. In the 2000 United States Census there were sixty-eight different and distinct self-reported racial categories, showing that race has already become demographically extinct. Yet, we must hasten to add that racism is just as virulent and divisive as it has ever been. The institution of racism is the omnipresent progeny of the nineteenth and twentieth century manifestations of slavery and its bedfellow, race.

How did slavery and race become so patently intertwined as distinctly American phenomena? Slavery in America was different from any other corner of the world primarily because in America it was viewed early on as the primary foundation upon which an emerging republic could solidify its economic primacy in the global



William Wilberforce

On Friday July 26th 1833 as he lay on his deathbed Wilberforce exclaimed: "Thank God that I have lived to witness the day in which England is willing to give £20 million for the abolishment of slavery." (What would that be worth today ?)
He died three days later.

The Slavery Abolition Bill 1833 passed through the House of Lords, it received the Royal Assent (which means it became law) on 29 August 1833 and came into force on 1 August 1834. On that date slavery was abolished throughout the vast British Empire. The Act automatically applied as new possessions (principally in Africa) subsequently became part of the British Empire.

To know who rules over you. Simply find out who it is that you are not allowed to criticise.
.....Voltaire

We, as White people, have been GAGGED!! Then bullied, insulted, demonised, and provoked, until we object and complain. We then get called *dirty names* like Nazi, Racist, White Extremist, etc, etc.

Our weak & corrupt Lib/Lab/Con Politicians are the problem. As of Jan 2021, the UK elections are years away. Check out Populism, and Nationalism ASAP. Become "WHITE WOKE" & Push Back.

Do it today, NOW!

word--'Boring!' For years, we have sent students to school and burdened them with the most tedious textbook imaginable--deadly dull books written by one set of professors to be read by another set of professors-- which completely sucks the life out of this most human of subjects.

In school books of an earlier era, the warts on our Founding Fathers' noses were neatly retouched. Slavery also got the glossy makeover--it was merely the misguided practice of the rebellious folks down south until the "progressives" of the north showed them the light.

Davis continues:

There has always been a tendency to hide the less savory moments from our past... . The history of this country is not necessarily a smooth continuum moving toward a perfectly realizable republic... . America remains shockingly divided along racial and economic lines.

Loewen writes:

High school students hate history. Students consider history the most irrelevant of twenty-one subjects commonly taught in high school.

Textbooks stifle meaning by suppressing causation. Students exit history textbooks without having developed the ability to think coherently about social life.

Our teachers and our textbooks still leave out most of what we need to know about the American past. Some of the factoids they present are flatly wrong or unverifiable.

In sum, startling errors of omission and distortion mar American histories.

Perhaps the most pervasive theme in our history is the domination of black America by white America. Race is the sharpest and deepest division in American life. Textbooks have trouble acknowledging that anything might be wrong with white Americans, or with the United States as a whole.

Slavery's twin relatives to the present are the social and economic inferiority it conferred upon blacks and the cultural racism it instilled in whites.

Racism in the western world stems primarily from two related historical processes: taking land from and destroying indigenous people and enslaving Africans to work the land.

Slavery in its simplest form is involuntary servitude. Yet most Americans do not fully understand the importance of slavery as the pivotal variable in early economic and political survival of the new republic following the American Revolution.

Elected officials and particularly presidents are the ultimate illusionists. For what other reason would they clamor to kiss babies, eat poorly cooked chicken with their fingers, take smiling pictures with total strangers, trot out the wife and kids conveniently to fake family values and attend black churches the Sunday before the November elections but to create an illusion of familiarity, compassion, trust, incredible slogans aimed at minorities? They strongly imply "just vote for me and I'll set you free." Lincoln, Roosevelt, Truman, Eisenhower, Kennedy, Johnson and even Nixon all cajoled black Americans into believing that their votes would indeed make for a better America. Some achieved more than others and we do not

demean Truman's executive order 9981 to desegregate the armed forces or Eisenhower sending in troops to quell racial tension surrounding school desegregation or Kennedy's affirmative action order or Johnson's support of the 1964 and 1965 Civil Rights and Voting Rights Acts. However, we should not be naïve enough to believe that, just as Lincoln carefully contemplated the correct political decision in 1862, so did Kennedy in 1960 when he placed the now much celebrated telephone call to the wife of Martin Luther King offering his assistance in getting him released from the Reidsville, Georgia jail. Kennedy knew all too well that he desperately needed the black southern vote. He also knew that King's father was one of the most influential black preachers in the south; ergo the call and Daddy King's endorsement from the pulpit and the presidential victory just weeks later by a slim margin.

Arthur Kenneth O'Reilly has written a definitive work on the racial attitudes of America's first forty-two presidents and in each instance he reveals that political expediency always superceded moral and ethical governance. He states,

To write of the forty-two chief executives and their deeds and dreams on matters of late yields few profiles in courage and a great many profiles of men who acquired and analyzed only in search of more perfect ways to protect slavery or Jim Crow The story of the presidency and the politics of race is thus largely a story of choices made to acquiesce in, preserve, and adapt the original intent of 1789 to modern times.

American slavery was an economic and political necessity without which the new republic would have certainly failed. Interestingly enough one of the most vociferous opponents of American slavery, David Walker, was one of the few abolitionists to articulate the economic necessity of free slave labor in seventeenth and eighteenth century America. Walker says, "The fact is, the labour of slaves comes so cheap to the avaricious usurpers, and is (as they think) of such great utility to the country where it exists, that those who are actuated by sordid avarice only, overlook the evils, which will as sure as the Lord lives, follow after the good."

The modern theorist who perhaps captures best the complex essence of slavery is Maulana Karanga. He postulates that American slavery was predicated on three major factors: its profitability, its practicality and its justifiability; without slavery, America could not have evolved and sustained itself as a free independent player in the growing global capitalist system of trade and politics. The profitability of 220 years of free labor is self-evident. African enslavement was clearly more practical than that originally attempted with white indentured servants and indigenous natives. Thus, the massive importation of Africans became the next best option. The first two factors could only be achieved and sustained if in fact an ideology could be developed to justify slavery. Finally the basis of the American system of enslavement was its justifiability in European racist thought. Although the enslavement of Africans was based on economic reasons, it also rested in racism as an ideology. Racism as an ideology became a justification and encouragement for enslavement. It expressed itself in religious' absurdities, biological absurdities and cultural absurdities. Thus, religiously it was argued God ordained whites to conquer, then civilize and Christianize the African "heathen." The biological absurdities included redefinition of Africans out of the human race, denying their history and humanity and giving them animal characteristics to suit their bestial treatment. Culturally we see this maddening scheme solidified in the cultural themes advanced by Darwin, Galton, Blumenbach, Freud, and many other white

theorists of the era.

Historical timelines lend considerable credence to the importance of "scientific" theory and the institutionalization of slavery in America immediately before the America Revolution, the Declaration of Independence and the U.S. Constitution. Stephen Jay Gould raised serious questions about what could be curiously labeled "historical coincidences." Noting that Johann Blumenbach established the most influential of all racial classification systems in 1775 in his doctoral dissertation, Gould argues:

As the minutemen of Lexington and Concord began the American Revolution . . . [Blumenbach] then republished the text for general distribution in 1776. The coincidence of three great documents in 1776-- Jefferson's Declaration of Independence (on the politics of liberty), Adam Smith's Wealth of Nations (on the economics of individualism) and Blumenbach's treatise on racial classification (on the science of human diversity)--records the social ferment of these decades and sets the wider context that makes Blumenbach's taxonomy, and his subsequent decision to call the European race Caucasian, so important for our history and current concerns.

An important and most relevant feature of Blumenbach's theory is that he identified the Caucasian race as superior in beauty, subtly changing the racial ordering in the world to a hierarchy of worth. This is the primary reason that Blumenbach rather than his mentor Carolus Linnaeus, who created the first racial taxonomy in 1759, is important in the beginning phase of American race theory and racism.

Following Linnaeus and Blumenbach were Charles Darwin's theory of natural selection, Sir Francis Galton's theory of eugenics (1883), both predicated on selective breeding and extermination of weaker races, and Sigmund Freud's theory of psycho-analysis, which laid the foundation for psychiatric studies. Thus, "When Africans were torn from their families and homes and sold into slavery in the United States, science stood ready to define any disobedience or insubordination as a 'mental illness.'"

The article further states that in 1851 a noted Louisiana physician Samuel Cartwright "discovered" two so-called mental diseases found exclusively among blacks that justified their enslavement. The first was "Drapetomania," which Cartwright professed to be a disease that caused black slaves to have an uncontrollable urge to run away from their masters. The prescribed treatment was prolonged whippings to exorcise the demons. The second disease, "Dysaesthesia Aethiopia," supposedly afflicted the mind and the body. The diagnostic symptoms included disobedience, answering disrespectfully to a master or overseer and refusing to work. The purported cure was to inflict extreme hard labor that would send vitalized blood to the brain to liberate the demented slave mind. The article concludes that "much scientific" and statistical rhetoric was used to justify slavery. One 1840 census "proved" that blacks living under "unnatural conditions of freedom" in the north were more prone to insanity. Dr. Edward Jarvis, a specialist in mental disorders, used this to conclude that slavery shielded blacks from some liabilities and dangers of active self-direction. Pseudo-sciences and skewed religious ideologies accomplished their purpose in convincing white America in the eighteenth and nineteenth centuries that blacks could in fact be mistreated, brutalized and discarded as troublesome property because they were not human

and, by virtue of this depersonalization, they were not entitled to humane treatment and civil or moral consideration.

Many slavery apologists took delight in expressing that the 1787 U.S. Constitution banned the importation of slaves 20 years hence, in 1808. However, "The federal law of 1808 was so weak and the enforcement of it so lax that a repeal was unnecessary to reopen the trade." According to John Hope Franklin, in 1790 there were fewer than 700,000 slaves in America. By 1830 the number rose to over two million and by 1850 the number of slaves was just under four million.

Although there are well document incidences of slave resistance and slave insurrections, the majority of slaves lived daily lives of what Cornel West calls nihilism. In describing the condition of African Americans in the ending years of the twentieth century he states,

Nihilism is not new in black America. The first African encounter with the New World was an encounter with a distinctive form of the absurd. The initial black struggle against degradation and devaluation in the enslaved circumstances of the New World was, in part, a struggle against nihilism. In fact, the major enemy of black survival in America has been and is neither oppression nor exploitation but rather the nihilistic threat--that is loss of hope and absence of meaning. For as long as hope remains and meaning is preserved, the possibility of overcoming oppression stays alive.

If meaninglessness, hopelessness and lovelessness are the foundations of nihilism and the plight of slaves two hundred years ago, it is also the daily plight of far too many blacks today even among those in the so-called black middle class. Without hope the homeless will remain defeated in their own minds, as will the illiterate, the medically unserved and underserved, the terminally ill, the wrongfully incarcerated, the unemployed and even the working poor. Without hope, a person's tomorrows will be no better than their todays. So what's the use in trying to improve?

For many black reparationists, this pervasive sense of nihilism is a twenty-first-century vestige of eighteenth-century slavery and therefore America, particularly its corporate entities, owe 35 million black Americans a debt. Randall Robinson, one of the prominent supporters of reparations writes, "There is no linear solution to our problems for our problems are not merely technical in nature. By now after nearly 380 years of unrelenting psychological abuse, the biggest problem is inside us."

Robinson continues, "What slavery had firmly established in the way of debilitating psychic pain and a lopsidedly unequal economic relationship of blacks to whites, formal organs of state and federal government would cement in law for the century that followed."

One of the more vexing questions inherent in the reparations movement is who among the 35 million blacks today would be the beneficiaries of the money and services associated with this trillion-dollar debt to black America? More basically, how would anyone determine who is black? Most blacks can only trace their genealogy back three and at best four generations, which places them at the door of the twentieth century and thirty-five years after the civil war ended slavery. Do we apply the infamous "one drop rule" or the one-eighth rule? Do we eliminate blacks with white ancestors? Would black billionaires Robert Johnson and Oprah



William Wilberforce

On Friday July 26th 1833 as he lay on his deathbed Wilberforce exclaimed: "Thank God that I have lived to witness the day in which England is willing to give £20 million for the abolishment of slavery." (What would that be worth today ?)

He died three days later.

The Slavery Abolition Bill 1833 passed through the House of Lords, it received the Royal Assent (which means it became law) on 29 August 1833 and came into force on 1 August 1834. On that date slavery was abolished throughout the vast British Empire. The Act automatically applied as new possessions (principally in Africa) subsequently became part of the British Empire.

To know who rules over you. Simply find out who it is that you are not allowed to criticise.Voltaire

We, as White people, have been GAGGED!! Then bullied, insulted, demonised, and provoked, until we object and complain. We then get called *dirty names* like Nazi, Racist, White Extremist, etc, etc.

Our weak & corrupt Lib/Lab/Con Politicians are the problem. As of Jan 2021, the UK elections are years away. Check out Populism, and Nationalism ASAP. Become "WHITE WOKE" & Push Back.

Do it today, NOW!

Winfrey receive the same reparations as the black Mississippi sharecropper or the homeless families in urban centers throughout the nation?

Reparations may be one modern solution to slavery but as a nation we need to transcend symbolism and racial tomfoolery and confront the totality of slavery with courage, conviction and an honest need for absolution of a nation's collective conscience. We all know that for true healing to occur, the root causes, rather than the symptoms, need to be diagnosed and then treated. If we return to our historic illusionist theme we will see that political history is replete with intentional distortions of reality to advance and maintain a public perception that belies the truth. Some examples of this historical magic would be Jefferson's liaison of twenty-eight years with his slave Sally Hemming, and the resulting seven offspring, Franklin Roosevelt's polio affliction, John Kennedy's chronic back ailment and resultant dependence on narcotic pain killers, Reagan's trickle down economics, Johnson's Vietnam War, Nixon's Watergate cover-up, Washington's cherry tree, and George W. Bush's fabricated reasons for going to war with Iraq in 2003.

On the matter of American slavery and a legitimate historical presentation of African culture and civilization before the seventeenth century, there appears to have been a solid conspiracy of white chroniclers of history who were doggedly committed to inventing and "scientifically" supporting the most extreme and damning stereotypical characterizations of black Americans. It is important to note that there were black intellectuals of that period who meticulously refuted these lies but they had no legitimate standing in the mainstream social science community and therefore their views were non-existent. However, there were a few liberal minded white philanthropists and social scientists who seemingly felt morally compelled to legitimize the existence of a distinct African culture, which went a long way in debunking the typical demeaning stereotypes, that had prevailed for almost 200 years. Foremost among these persons was Columbia University anthropologist Melville J. Herskovits who in 1940 published "The Myth of the Negro Past." This book was the result of seventeen years of research on the Negro in Africa, South America, the West Indies and in the United States.

Herskovits was one of only ten scholars asked to participate in the most comprehensive scientific study ever conducted on the American Negro. The complete study, "The American Dilemma," that was directed by Swedish social scientist Karl Gunnar Myrdal, was released over a year after Herskovits' study. The scientific conclusion of Herskovits was that the American Negro, contrary to the prevailing ideology of the past three centuries, has a rich and highly developed African culture and history. He stated, "This book when first published, discussed and documented, a position that at the time was less than congenial to the considerable number of intellectuals who accommodated their thinking to the position of an important and established group of social scientists and students."

The prevailing ideology then concerning the American Negro was captured by Lewis C. Copeland who wrote, "The South's dependence on the Negro is further obscured by the belief in the complete dependence of the black race upon the white race for moral as well as for economic support. The Negro is thought of as a child race, the ward of the civilized white man. We are told, "The savage and uncivilized black man lacks the ability to organize his social life on the level of the white community. He is unrestrained and requires the constant control of white people to keep him in check."

In addition to refuting this venal propaganda, Herskovits also recognized and legitimized the scholarship of his black intellectual contemporaries who also had through rigorous scientific scholarship challenged the widespread racism expressed by these white prophets of hate. Foremost among the black scholars were W.E.B. DuBois, Carter G. Woodson and Charles Johnson all of whom had written extensively on the rich and valuable cultural heritage of blacks in America. Yet, they were unanimously ignored and discredited by their white counterparts. Then, for the first time ever, Herskovits stated and reaffirmed what DuBois, Woodson and Johnson had been saying for over forty years:

DuBois held fast to his beliefs and fought valiantly for his race, saying, I do not for a moment doubt that my Negro descent and narrow group culture have in my cases predisposed me to interpret my facts too favorably for my race; but there is little danger of misleading here for the champions of white folk are legion. The Negro has long been the clown of history; the football of anthropology and the slave of industry. I am trying to show here why these attitudes can no longer be maintained. I realize that the truth of history lies not in the mouth of the partisans but in the calm science that sits between her cause I seek to save, and wherever I fail, I am at least paying truth the respect of earnest effort.

Discouraged and frustrated, DuBois renounced his American citizenship and moved to Ghana in 1961. Two years later on the eve of the 1963 March on Washington, he died peacefully at the age of ninety-six. There is great significance in the travails of persons such as Herskovits and DuBois. First, their protracted life long struggles point out the virulent entrenched malignancy of institutionalized racism in America. In spite of the renowned work of the legions of truth seeking social scientists who labored on behalf of justice and equality for the African American, today we still see clear vestiges of this evil social millstone that had its genesis in seventeenth century slavery. Herskovits died on February 25, 1963 a mere six months before his friend and colleague DuBois. He was only sixty-eight years old and never relented in his commitment to his life long struggle for enlightened Negro history.

In his most recent work "Who Owns History: Rethinking the Past in a Changing World," Eric Foner states:

A second set of debates centered on the legacy of slavery and the Civil War. In an essay on historical consciousness, Friedrich Nietzsche spoke of "creative forgetfulness"--how the memory of some aspects of the past is predicated on amnesia among others. Slavery is a case in point. Nowhere is the gap between scholarly inquiry and public perceptions of history more stark. It is probably safe to say that the finest body of American historical writing to appear during the past thirty years has been produced by scholars of slavery and emancipation. This literature has not only established beyond question the centrality of slavery to the history of the United States but has refashioned our understanding of subjects ranging from colonial settlement to the American Revolution and the origins and consequences of the Civil War.

Americans must not be blinded or deluded by the purported noblesse oblige of the Emancipation Proclamation, the Thirteenth, Fourteenth, and Fifteenth amendments to the Constitution, the 1948 Truman executive order, the Brown v. Board of Education decision nor the 2003 pro-affirmative action Supreme Court decision. Racial discrimination should have begun to moderate after the



William Wilberforce

On Friday July 26th 1833 as he lay on his deathbed Wilberforce exclaimed: "Thank God that I have lived to witness the day in which England is willing to give £20 million for the abolishment of slavery." (What would that be worth today ?)

He died three days later.

The Slavery Abolition Bill 1833 passed through the House of Lords, it received the Royal Assent (which means it became law) on 29 August 1833 and came into force on 1 August 1834. On that date slavery was abolished throughout the vast British Empire.

The Act automatically applied as new possessions (principally in Africa) subsequently became part of the British Empire.

To know who rules over you. Simply find out who it is that you are not allowed to criticise.Voltaire

We, as White people, have been GAGGED!! Then bullied, insulted, demonised, and provoked, until we object and complain. We then get called *dirty names* like Nazi, Racist, White Extremist, etc, etc.

Our weak & corrupt Lib/Lab/Con Politicians are the problem. As of Jan 2021, the UK elections are years away. Check out Populism, and Nationalism ASAP. Become "WHITE WOKE" & Push Back.

Do it today, NOW!



William Wilberforce

On Friday July 26th 1833 as he lay on his deathbed Wilberforce exclaimed: "Thank God that I have lived to witness the day in which England is willing to give £20 million for the abolishment of slavery." (What would that be worth today ?)

He died three days later.

The Slavery Abolition Bill 1833 passed through the House of Lords, it received the Royal Assent (which means it became law) on 29 August 1833 and came into force on 1 August 1834. On that date slavery was abolished throughout the vast British Empire.

The Act automatically applied as new possessions (principally in Africa) subsequently became part of the British Empire.

To know who rules over you. Simply find out who it is that you are not allowed to criticise.Voltaire

We, as White people, have been GAGGED!! Then bullied, insulted, demonised, and provoked, until we object and complain. We then get called *dirty names* like Nazi, Racist, White Extremist, etc, etc.

Our weak & corrupt Lib/Lab/Con Politicians are the problem. As of Jan 2021, the UK elections are years away. Check out Populism, and Nationalism ASAP. Become "WHITE WOKE" & Push Back.

Do it today, NOW!

Constitution outlawed the importation of slaves in 1808. Yet it did not, primarily because the inhumane treatment of blacks had already become an integral part of our social, economic, and political order. A prime example is the three-fifths compromise that was also in the 1787 U. S. Constitution. In 1968, Stokely Carmichael and Charles Hamilton politely defined racism as "the predication of decisions and policies on considerations of race for the purpose of subordinating a racial group and maintaining control over it."

I submit a more pointed definition of racism. Racism is, "the everlasting legacy of American slavery that with ruthless intentionality oppresses, represses and commits cultural genocide against people of color but particularly black Americans. It is manifested in all of the primary social, economic, educational and political institutions in America. Oppression puts a people down, repression keeps them down and cultural genocide infests their lives with pervasive nihilism. It kills their spirit and strips them of hope." Evidence of racism is seen daily in substandard housing, haphazard healthcare, mis-education, discriminatory criminal sentencing and symbolic political patronizing. To create the illusion of progress, some blacks are selectively included in the mainstream of American life, most are marginalized and those at the bottom who make up the permanent underclass engage in daily suicidal rituals that mirror suicide among slaves, starting with throwing themselves overboard during the Middle Passage.

Is this critical American problem that Mrydal referred to in 1944 as the American Dilemma solvable?

Conclusion

How incredibly ironic it is that the most popularly advanced topics in social anthropology today are prima facie evidence that the earliest bipedal humanoids physiologically were Negroid in nature and fully capable of intelligent decision making. Intelligence in its most rudimentary form is the ability to solve problems. Many of the daily problems confronted by this seven million year old humanoid were resolved by the invention of fire. Initially warmth against the climatic elements and cooking and preservation of food were key features of the utilizing of fire. However, centuries later the use of fire in the smelting of iron revolutionized tool making, weaponry and early industrialization.

Here and elsewhere, particularly in the Great Congo Valley, the use of iron characterized Africa. As Franz Boas says: It seems likely that at a time when the European was still satisfied with rude stone tools, the African had invented or adopted the art of smelting iron. Consider for a moment what this invention has meant for the advance of the human race. As long as the hammer, knife, saw, drill, the spade and the hoe had to be chipped out of stone, or had to be made of shell or wood, effective industrial work was not impossible but difficult. A great progress was made when copper found in large nuggets was hammered out into tools and later on shaped by melting, and when bronze was introduced; but the true advancement of industrial life did not begin until the hard iron was discovered. It seems not unlikely that the people who made the marvelous discovery of reducing iron ores by smelting were African Negroes.

If we return to the original illusionist theme of this discussion one can only be amazed by the degree of deception that American history has heaped upon an unsuspecting public. Adding yet more incredulity to the equation is the fact that

one of the original scientific racist, Charles Darwin acknowledged in his second publication after the Origin of Species (1859), Descent of Man (1871), that Africa was the cradle of modern civilization. John Jackson writes, "In 1871 Darwin's Descent of Man was issued, and in this book the father of Natural Selection produced impressive evidence that man and the anthropoid apes could be traced to a common ancestor. Most of Darwin's contemporaries favored the continent of Asia as the birth place of the human race, but Darwin suggested that Africa was most likely to have been the Cradle of Mankind." Viewing these two early works of Darwin independently suggests the scholarly progression of the leading evolutionist of the era. However, if we examine these works within the context of American slavery, then we see a whole different paradigm emerging.

Earlier in this paper we cited the suspicion raised by Stephen Jay Gould regarding the historical coincidence of emerging race theory advanced by Darwin, Galton, Blumenbach, et.al and the virulence of institutional racism between 1787 and 1877 (end of Reconstruction). Even though slavery may have officially ended with the civil war, racism perpetuated the slave-master mentality for another one hundred years. The scientific and religious conclusion then centered around portraying American blacks and Africans as void of a culture, civilization, civility and intelligence. Accordingly, the scientific conclusion is natural selection, a master white race and manifest destiny were more valuable for the 19th century power brokers than would have been acknowledging African legitimacy as well as African Americans' achievements such as: Oberlin College in Ohio being integrated in 1833 and Blacks constituting one third of the student body at the start of the civil war (1861); or that in 1823 Alexander Twilight became the first black to graduate from an American college (Middleburg); or that in 1850, Lucy Session became the first Black woman to graduate from an American college (Oberlin) or that in 1849, John D. and Thomas T. White became the first Black doctors to graduate from a U.S. Medical school (Bowdoin). Similarly after the civil war in 1874, Edward Bouchette was the first black to be elected to Phi Beta Kappa and in 1876 became the first black to receive a Ph.D. in Physics (Yale). It is easy to see why it was of the utmost importance to continue the lie of black inferiority, infantilism and ignorance. American historians have for well over 150 years deceived a nation by keeping its citizens in Plato's cave wherein they were only able to view reality filtered through the shadows of scientific racism and religious propaganda. It is only now in the year 2004 that we see two of the most highly respected scientific journals not only acknowledging but celebrating Africa as the cradle of civilization and Africans as major contributors to the seven million year existence of mankind on planet earth.

Perhaps Americans should be guardedly optimistic about these new revelations that have been intentionally obscured for far too many generations. We should be able to see why this issue of slavery, 139 years after its official demise, still is fodder for the diehard racists but at the same time fertile ground for life after the illusionists. Little did Jefferson, Adams, Franklin and the other founders know that in spite of their gross constitutional injustice to African American in 1787, these wrongs would at long last be corrected in the twenty-first century.

On July 9, 2003, the 43rd President of the United States of America, George W. Bush stood on Goree Island in Senegal West Africa and declared slavery to be "history's worst crime" and admonished the founding fathers for heaping hypocrisy upon injustice by the manner in which they dealt with slavery.

Eleven years earlier, one of America's most distinguished historic figures, Lawrence Douglas Wilder, the first elected African American governor of a state (Virginia), visited this same tract of land on Goree Island. Wilder, the grandson of slaves, announced in 1993 that a United States National Slavery Museum would be created so that America, and particularly her children, could be educated about the extreme importance slavery played in not only the creation of America but also its centrality to the social, economic, political and psychological character of the nation.

Socially, the institution of slavery established rules both written and unwritten for black/white relations in America. Economically, slavery was the foundation upon which America's international power was developed. Politically, slavery was the bait that helped spark the American Revolutionary War in 1776 as the colonials excoriated King George III for supporting the slave trade worldwide. Yet, in 1788, when the U.S. Constitution was ratified, America permanently rendered African Americans chattel, relegated to a non-entity status with a legal value of three fifths of a white man. Psychologically, due to the human and cultural degradation of blacks, the nation began to institute laws, policies, norms, and daily practices that engendered the deep self hate in blacks that persists to this day. Similarly, the black-white inferiority-superiority dichotomy evolved in the white community. Wilder's dream of an American slavery museum is about to become a reality on the banks of the Rappahannock River in Fredericksburg, Virginia. It is here that the full story of American slavery will be told.



William Wilberforce

On Friday July 26th 1833 as he lay on his deathbed Wilberforce exclaimed: "Thank God that I have lived to witness the day in which England is willing to give £20 million for the abolishment of slavery." (What would that be worth today ?)

He died three days later.

The Slavery Abolition Bill 1833 passed through the House of Lords, it received the Royal Assent (which means it became law) on 29 August 1833 and came into force on 1 August 1834.

On that date slavery was abolished throughout the vast British Empire.

The Act automatically applied as new possessions (principally in Africa) subsequently became part of the British Empire.

To know who rules over you. Simply find out who it is that you are not allowed to criticise.Voltaire

We, as White people, have been GAGGED!! Then bullied, insulted, demonised, and provoked, until we object and complain. We then get called *dirty names* like Nazi, Racist, White Extremist, etc, etc.

Our weak & corrupt Lib/Lab/Con Politicians are the problem. As of Jan 2021, the UK elections are years away. Check out Populism, and Nationalism ASAP. Become "WHITE WOKE" & Push Back.

Do it today, NOW!

Slavery Myths Debunked



William Wilberforce

On Friday July 26th 1833 as he lay on his deathbed Wilberforce exclaimed: "Thank God that I have lived to witness the day in which England is willing to give £20 million for the abolishment of slavery." (What would that be worth today?)

He died three days later.

The Slavery Abolition Bill 1833 passed through the House of Lords, it received the Royal Assent (which means it became law) on 29 August 1833 and came into force on 1 August 1834. On that date slavery was abolished throughout the vast British Empire.

The Act automatically applied as new possessions (principally in Africa) subsequently became part of the British Empire.

To know who rules over you. Simply find out who it is that you are not allowed to criticise.Voltaire

We, as White people, have been GAGGED!! Then bullied, insulted, demonised, and provoked, until we object and complain. We then get called *dirty names* like Nazi, Racist, White Extremist, etc, etc.

Our weak & corrupt Lib/Lab/Con Politicians are the problem. As of Jan 2021, the UK elections are years away. Check out Populism, and Nationalism ASAP. Become "WHITE WOKE" & Push Back.

Do it today, NOW!

indentured servitude in the "new world" and forcibly shipped across the Atlantic. But even involuntary laborers had more autonomy than enslaved Africans, and the large majority of Irish indentured servants came here voluntarily.

Which raises a question: Where did the myth of Irish slavery come from? A few places. The term "white slaves" emerged in the 17th and 18th centuries, first as a derogatory term for Irish laborers—equating their social position to that of slaves—later as political rhetoric in Ireland itself, and later still as Southern pro-slavery propaganda against an industrialized North. More recently, Hogan notes, several sources have conflated indentured servitude with chattel slavery in order to argue for a particular Irish disadvantage in the Americas, when compared to other white immigrant groups. Hogan cites several writers—Sean O’Callaghan in *To Hell or Barbados* and Don Jordan and Michael Walsh in *White Cargo: The Forgotten History of Britain’s White Slaves in America*—who exaggerate poor treatment of Irish indentured servants and intentionally conflate their status with African slaves. Neither of the authors “bother to inform the reader, in a coherent manner, what the differences are between chattel slavery and indentured servitude or forced labor,” writes Hogan.

This is an important point. Indentured servitude was difficult, deadly work, and many indentured servants died before their terms were over. But indentured servitude was temporary, with a beginning and an end. Those who survived their terms received their freedom. Servants could even petition for early release due to mistreatment, and colonial lawmakers established different, often lesser, punishments for disobedient servants compared to disobedient slaves. Above all, indentured servitude wasn’t hereditary. The children of servants were free; the children of slaves were property. To elide this is to diminish the realities of chattel slavery, which—perhaps—is one reason the most vocal purveyors of the myth are neo-Confederate and white supremacist groups.

Bottom line: Even if many Irish immigrants faced discrimination and hard lives on these shores, it doesn’t change the fact that American slavery—hereditary and race-based—was a massive institution that shaped and defined the political economy of colonial America, and later, the United States. Nor does it change the fact that this institution left a profound legacy for the descendants of enslaved Africans, who even after emancipation were subject to almost a century of violence, disenfranchisement, and pervasive oppression, with social, economic, and cultural effects that persist to the present.

“Black people enslaved each other in Africa, and black people worked with slave traders, so ...”

In a piece published in *Vice* magazine in 2005 (and still available on the *Vice* website), comedian Jim Goad offers a series of “feel better about your history, white kids” arguments. One of his salvos: “Slavery was common throughout Africa, with entire tribes becoming enslaved after losing battles. Tribal chieftains often sold their defeated foes to white slave-traders.”

By Jamelle Bouie and Rebecca Onion

From <http://www.slate.com>

The Irish were slaves too; slaves had it better than Northern factory workers; black people fought for the Confederacy; and other lies, half-truths, and irrelevancies.

By Jamelle Bouie and Rebecca Onion

A certain resistance to discussion about the toll of American slavery isn’t confined to the least savory corners of the Internet. Last year, in an unsigned (and now withdrawn) review of historian Ed Baptist’s book *The Half Has Never Been Told*, the *Economist* took issue with Baptist’s “overstated” treatment of the topic, arguing that the increase in the country’s economic output in the 19th century shouldn’t be chalked up to black workers’ innovations in the cotton field but rather to masters treating their slaves well out of economic self-interest—a bit of seemingly rational counterargument that ignores the moral force of Baptist’s narrative, while making space for the fantasy of kindly slavery. In a June column on the legacy of Robert E. Lee that was otherwise largely critical of the Confederate general, *New York Times* op-ed columnist David Brooks wrote that, though Lee owned slaves, he didn’t like owning slaves—a biographical detail whose inclusion seemed to imply that Lee’s ambivalence somehow made his slaveholding less objectionable. And in an August obituary of civil rights leader Julian Bond, the *Times* called his great-grandmother Jane Bond “the slave mistress of a Kentucky farmer”—a term that accords far too much agency to Bond’s ancestor and too little blame to the “farmer” who enslaved her.

While working on our Slate Academy podcast, *The History of American Slavery*, we encountered many types of slavery denial—frequently disguised as historical correctives and advanced by those who want to change (or end) conversation about the deep impact of slavery on American history. We’d like to offer counterarguments—some historical, some ethical—to the most common misdirections that surface in conversations about slavery.

“The Irish Were Slaves Too”

Is it true?: If we’re talking about slavery as it was practiced on Africans in the United States—that is, hereditary chattel slavery—then the answer is a clear no. As historian and public librarian Liam Hogan writes in a paper titled “The Myth of ‘Irish Slaves’ in the Colonies,” “Persons from Ireland have been held in various forms of human bondage throughout history, but they have never been chattel slaves in the West Indies.” Nor is there any evidence of Irish chattel slavery in the North American colonies. There were a large number of Irish indentured servants, and there were cases in which Irish men and women were sentenced to



William Wilberforce

On Friday July 26th 1833 as he lay on his deathbed Wilberforce exclaimed: "Thank God that I have lived to witness the day in which England is willing to give £20 million for the abolishment of slavery." (What would that be worth today ?)

He died three days later.

The Slavery Abolition Bill 1833 passed through the House of Lords, it received the Royal Assent (which means it became law) on 29 August 1833 and came into force on 1 August 1834.

On that date slavery was abolished throughout the vast British Empire.

The Act automatically applied as new possessions (principally in Africa) subsequently became part of the British Empire.

To know who rules over you. Simply find out who it is that you are not allowed to criticise.Voltaire

We, as White people, have been GAGGED!! Then bullied, insulted, demonised, and provoked, until we object and complain. We then get called *dirty names* like Nazi, Racist, White Extremist, etc, etc.

Our weak & corrupt Lib/Lab/Con Politicians are the problem. As of Jan 2021, the UK elections are years away. Check out Populism, and Nationalism ASAP. Become "WHITE WOKE" & Push Back.

Do it today, NOW!

Is it true?: This is certainly true. But, as historian Marcus Rediker writes, the “ancient and widely accepted institution” of enslavement in Africa was exacerbated by the European presence. Yes, European slave traders entered “preexisting circuits of exchange” when they arrived in the 16th century. But European demand changed the shape of this market, strengthening enslavers and ensuring that more and more people would be carried away. “[European] slave-ship captains wanted to deal with ruling groups and strong leaders, people who could command labor resources and deliver the ‘goods,’ ” Rediker writes, and European money and technology further empowered those who were already dominant, encouraging them to enslave greater numbers. Both the social structures and infrastructure that enabled African systems of enslavement were strengthened by the transatlantic slave trade.

Bottom line: Why should this matter? This is a classic “two wrongs make a right” ethical proposition. Even if Africans (or Arabs, or Jews) colluded in the slave trade, should white Americans be entitled to do whatever they pleased with the people who were unlucky enough to fall victim?

“The first slave owner in America was black.”

Is it true?: It depends on how you parse the timeline. Anthony Johnson, the black ex-indentured servant whose bio opened the first episode of our podcast, did sue to hold John Casor for life in 1653, and the resulting civil court decision remanding Casor to Johnson’s ownership was (as historian R. Halliburton Jr. writes) “one of the first known legal sanctions of slavery” in the colonies. That phrase—“one of”—is crucial. The ship Desire brought a cargo of Africans from Barbados to Boston in 1634; these people were sold as slaves. In 1640 John Punch, a runaway servant of African descent, was sentenced to lifelong slavery in Virginia, while the two European-born companions who fled with him had their indentures extended. In 1641, the passage of the Body of Liberties provided legal sanction for the slave trade in the Massachusetts Bay Colony. (N.B.: The image in the meme above isn’t of Anthony Johnson. There were no photographers in 17th-century Virginia.)

Whether or not Anthony Johnson was the first American slaveholder, he was certainly not the last black person to own slaves. “It is a very sad aspect of African-American history that slavery sometimes could be a colorblind affair,” writes Henry Louis Gates Jr. on the Root, in a fascinating piece about the history of black slaveholders in the United States. Some black slaveholders bought family members, though this humanitarian arrangement doesn’t account for all of the history of black slaveholding, as Gates points out.

Bottom line: Even if Anthony Johnson was the first person in the North American colonies to hold a slave—even if many black people across the years held slaves—that doesn’t erase the fact that it was the racially based system of hereditary slavery that harmed the vast majority of black people living within it. The fact that some members of an oppressed class participate in oppression doesn’t excuse that oppression.

“Slaves were better off than some poor people working in Northern or English factories. At least they were given food and a place to stay.”

Is it true?: It was undeniably hard to be a factory worker in the 19th century. White adults (and children) labored in dangerous environments and were often hungry. But slaves were hardly in a better position.

While it makes some intuitive sense that a person would be rationally motivated to take care of his or her “property,” as the Economist’s reviewer suggested, historians have found that American slaveholders were apt to provide minimum levels of food and shelter for enslaved people. They considered black people’s palates to be less refined than white people’s, and this justified serving a monotonous diet of pork and cornmeal. Enslaved workers were expected to supplement their diets when they could, by tending their own vegetable gardens and hunting or trapping—more work to be added to their already heavy loads. Evidence shows that many enslaved people suffered from diseases associated with malnutrition, including pellagra, rickets, scurvy, and anemia.

Even if an enslaved person in the United States landed in a relatively “good” position—owned by a slaveholder who was inclined to feed workers well and be lenient in punishment—he was always subject to sale, which could happen because of death, debt, arguments in the family, or whim. Since very few laws regulated slaveholders’ treatment of enslaved people, there would be no guarantee that the next place the enslaved person landed would be equally comfortable—and the enslaved had limited opportunity, short of running away or resisting, to control the situation.

Bottom line: This is another case of the “two wrongs” fallacy. We could compare levels of mistreatment of Northern factory workers and Southern enslaved laborers and find that each group lived with hunger and injury; both findings are dismaying. But this is a distraction from the real issue: Slavery, as a system, legalized and codified the slaveholder’s control over the enslaved person’s body.

“Only a small percentage of Southerners owned slaves.”

“The vast majority of soldiers in the Confederate Army were simple men of meager income,” rather than wealthy slaveholders, writes the anonymous author of a widely-circulated Confederate History “fact sheet.”

Is it true?: According to the 1860 census, taken just before the Civil War, more than 32 percent of white families in the soon-to-be Confederate states owned slaves. Of course, this is an average, and different states had different levels of slaveholding. In Arkansas, just 20 percent of families owned slaves; in South Carolina, it was 46 percent; in Mississippi, it was 49 percent.

By most measures, this isn’t “small”—it’s roughly the same percentage of Americans who, today, hold a college degree. The large majority of slaveholding families were small farmers and not the major planters who dominate our image of “slavery.”



William Wilberforce
 On Friday July 26th 1833 as he lay on his deathbed Wilberforce exclaimed: "Thank God that I have lived to witness the day in which England is willing to give £20 million for the abolishment of slavery." (What would that be worth today ?)
 He died three days later.

The Slavery Abolition Bill 1833 passed through the House of Lords, it received the Royal Assent (which means it became law) on 29 August 1833 and came into force on 1 August 1834. On that date slavery was abolished throughout the vast British Empire. The Act automatically applied as new possessions (principally in Africa) subsequently became part of the British Empire.

To know who rules over you. Simply find out who it is that you are not allowed to criticise.Voltaire

We, as White people, have been GAGGED!! Then bullied, insulted, demonised, and provoked, until we object and complain. We then get called *dirty names* like Nazi, Racist, White Extremist, etc, etc.

Our weak & corrupt Lib/Lab/Con Politicians are the problem. As of Jan 2021, the UK elections are years away. Check out Populism, and Nationalism ASAP. Become "WHITE WOKE" & Push Back.

Do it today, NOW!

Is it true?: Here is a case where rhetorical precision is key. Did blacks serve in the Confederacy? Absolutely: As enslaved people, countless black Americans cooked, cleaned, and worked for Confederate regiments and their officers. But they didn't fight; there's no evidence that black Americans—enslaved or free—fought Union soldiers under Confederate banners.

Toward the end of the war, a desperate Confederate Congress allowed its army to enlist enslaved Africans who had been freed by their masters. A small number of black soldiers were trained, but there's no evidence they saw action. And even this measure was divisive: Opponents attacked it as a betrayal of the Confederacy's aim and purpose. "You cannot make soldiers of slaves, or slaves of soldiers," declared Howell Cobb, president of the Provisional Confederate State Congress that drafted the Confederate States of America constitution. "The day you make a soldier of them is the beginning of the end of the Revolution. And if slaves seem good soldiers, then our whole theory of slavery is wrong."

The myth is a product of the post-war period, when former Confederate leaders worked to retroactively redefine secession from a movement to preserve slavery to a fight for abstract "state's rights" and a hazy "Southern way of life."

Bottom line: Even if there were black soldiers in the Confederate army, it doesn't change the truth of the Confederacy: Its goal was the protection and expansion of slavery. The institution was protected in the Confederate constitution. "Our new government is founded upon ... the great truth that the negro is not equal to the white man; that slavery subordination to the superior race is his natural and normal condition," said Confederate vice president Alexander Stephens in his "Cornerstone Speech." "This, our new government, is the first, in the history of the world, based upon this great physical, philosophical, and moral truth."



Typically, this fact is used to suggest that the Civil War was not about slavery. If so few Southerners owned slaves, goes the argument, then the war had to be about something else (namely, the sanctity of states' rights). But, as historian Ira Berlin writes, the slave South was a slave society, not just a society with slaves. Slavery was at the foundation of economic and social relations, and slave-ownership was aspirational—a symbol of wealth and prosperity. Whites who couldn't afford slaves wanted them in the same way that, today, most Americans want to own a home.

Bottom line: Slavery was the basis of white supremacy, which united all whites in a racist hierarchy. "[T]he existing relation between the two races in the South," argued South Carolina Sen. John C. Calhoun in 1837, "forms the most solid and durable foundation on which to rear free and stable political institutions." Many whites couldn't imagine Southern society without slavery. And when it was threatened, those whites—whether they owned slaves or not—took up arms to defend their "way of life."

"The North benefited from slavery, too."

Is it true?: There's no question that this is true. As historians Ed Baptist and Sven Beckert show in their respective books, American slavery was an economic engine for the global economy. The South's production of cotton drove industrialization and fueled a massive commodities market that transformed the world. Naturally, this meant that slavery was vital to Northern financial and industrial interests. It's no coincidence, for instance, that New York City was among the most pro-Southern cities in the North during the Civil War; slavery was key to its economic success. In any honest conversation about American slavery, we have to look at the tight economic links between North and South and the degree to which the entire country was complicit in the enterprise.

Bottom line: Often, this line comes from Southern defenders, who want to emphasize Northern complicity. But the two types of historical guilt aren't mutually exclusive. It's true that the North played a major role in sustaining the slave economy. It's also true that slavery was based in the American South; that it formed the basis of Southern society; that white Southerners were its most fervent defenders; and that those Southerners would eventually fight a war to preserve and expand the institution.

"Black people fought for the Confederacy."

"Historical fact shows there were Black Confederate soldiers. These brave men fought in the trenches beside their White brothers, all under the Confederate Battle Flag," reads a statement from the South Carolina chapter of the Sons of Confederate Veterans.

In 1807 Britain Outlawed Slavery

In 1820 the king of the African kingdom of Ashanti inquired why the Christians did not want to trade slaves with him anymore, since they worshipped the same god as the Muslims and the Muslims were continuing the trade like before.

From <http://www.scaruffi.com/politics/slavetra.html>

The civil rights movement of the 1960's have left many people with the belief that the slave trade was exclusively a European/USA phenomenon and only evil white people were to blame for it. This is a simplistic scenario that hardly reflects the facts.

Thousands of records of transactions are available on a CDROM prepared by Harvard University and several comprehensive books have been published recently on the origins of modern slavery (namely, Hugh Thomas' *The Slave Trade* and Robin Blackburn's *The Making Of New World Slavery*) that shed new light on centuries of slave trading.

What these records show is that the modern slave trade flourished in the early middle ages, as early as 869, especially between Muslim traders and western African kingdoms. For moralists, the most important aspect of that trade should be that Muslims were selling goods to the African kingdoms and the African kingdoms were paying with their own people. In most instances, no violence was necessary to obtain those slaves. Contrary to legends and novels and Hollywood movies, the white traders did not need to savagely kill entire tribes in order to exact their tribute in slaves. All they needed to do is bring goods that appealed to the kings of those tribes. The kings would gladly sell their own subjects. (Of course, this neither condones the white traders who bought the slaves nor deny that many white traders still committed atrocities to maximize their business).

This explains why slavery became "black". Ancient slavery, e.g. under the Roman empire, would not discriminate: slaves were both white and black (so were Emperors and Popes). In the middle ages, all European countries outlawed slavery (of course, Western powers retained countless "civilized" ways to enslave their citizens, but that's another story), whereas the African kingdoms happily continued in their trade. Therefore, only colored people could be slaves, and that is how the stereotype for African-American slavery was born. It was not based on an ancestral hatred of blacks by whites, but simply on the fact that blacks were the only ones selling slaves, and they were selling people of their own race. (To be precise, Christians were also selling Muslim slaves captured in war, and Muslims were selling Christian slaves captured in war, but neither the Christians of Europe nor the Muslims of Africa and the Middle East were selling their own people).

Then the Muslim the trade of African slaves declined rapidly when Arab domination was reduced by the emerging European powers. (Note: Arabs continued to capture and sell slaves, but mostly in the Mediterranean. In fact, Robert Davis estimates that 1.25 million European Christians were enslaved by the "barbary states" of northern Africa. As late as 1801 the USA bombed Morocco,

Algiers, Tunis and Tripoli precisely to stop that Arab slave trade of Christians. The rate of mortality of those Christian slaves in the Islamic world was roughly the same as the mortality rate in the Atlantic slave trade of the same period.)

Christians took over in black Africa, though. The first ones were the Portuguese, who, applying an idea that originally developed in Italian seafaring cities, and often using Italian venture capital, started exploiting sub-Saharan slaves in the 1440s to support the economy of the sugar plantations (mainly for their own African colonies of Sao Tome and Madeira).

The Dutch were the first, apparently, to import black slaves into North America, but black slaves had already been employed all over the world, including South and Central America. We tend to focus on what happened in North America because the United States would eventually fight a war over slavery (and it's in the U.S. that large sectors of the population would start condemning slavery, contrary to the indifference that Muslims and most Europeans showed for it).

Even after Europeans began transporting black slaves to America, most trade was just that: "trade". In most instances, the Europeans did not need to use any force to get those slaves. The slaves were "sold" more or less legally by their (black) owners. Scholars estimate that about 12,000,000 Africans were sold by Africans to Europeans (most of them before 1776, when the USA wasn't yet born) and 17,000,000 were sold to Arabs. The legends of European mercenaries capturing free people in the jungle are mostly just that: legends. A few mercenaries certainly stormed peaceful tribes and committed terrible crimes, but that was not the rule. There was no need to risk their lives, so most of them didn't: they simply purchased people.

As an African-American scholar (Nathan Huggins) has written, the "identity" of black Africans is largely a white invention: sub-Saharan Africans never felt like they were one people, they felt (and still feel) that they belonged to different tribes. The distinctions of tribe were far stronger than the distinctions of race.

Everything else is true: millions of slaves died on ships and of diseases, millions of blacks worked for free to allow the Western economies to prosper, and the economic interests in slavery became so strong that the southern states of the United States opposed repealing it. But those millions of slaves were just one of the many instances of mass exploitation: the industrial revolution was exported to the USA by entrepreneurs exploiting millions of poor immigrants from Europe. The fate of those immigrants was not much better than the fate of the slaves in the South. As a matter of fact, many slaves enjoyed far better living conditions in the southern plantations than European immigrants in the industrial cities (which were sometimes comparable to concentration camps). It is not a coincidence that slavery was abolished at a time when millions of European and Chinese immigrants provided the same kind of cheap labor.

It is also fair to say that, while everybody tolerated it, very few whites practiced slavery: in 1860 there were 385,000 USA citizens who owned slaves, or about 1.4% of the white population (there were 27 million whites in the USA). That percentage was zero in the states that did not allow slavery (only 8 million of the 27 million whites lived in states that allowed slavery). Incidentally, in 1830 about 25% of the free Negro slave masters in South Carolina owned 10 or more slaves: that is a much higher percentage (ten times more) than the number of white slave owners.



William Wilberforce

On Friday July 26th 1833 as he lay on his deathbed Wilberforce exclaimed: "Thank God that I have lived to witness the day in which England is willing to give £20 million for the abolishment of slavery." (What would that be worth today ?) He died three days later.

The Slavery Abolition Bill 1833 passed through the House of Lords, it received the Royal Assent (which means it became law) on 29 August 1833 and came into force on 1 August 1834. On that date slavery was abolished throughout the vast British Empire. The Act automatically applied as new possessions (principally in Africa) subsequently became part of the British Empire.

To know who rules over you. Simply find out who it is that you are not allowed to criticise.Voltaire

We, as White people, have been GAGGED!! Then bullied, insulted, demonised, and provoked, until we object and complain. We then get called *dirty names* like Nazi, Racist, White Extremist, etc, etc.

Our weak & corrupt Lib/Lab/Con Politicians are the problem. As of Jan 2021, the UK elections are years away. Check out Populism, and Nationalism ASAP. Become "WHITE WOKE" & Push Back.

Do it today, NOW!

Thus slave owners were a tiny minority (1.4%) and it was not only whites: it was just about anybody who could, including blacks themselves.

Moral opposition to slavery was widespread even before Lincoln, and throughout Europe. On the other hand, opposition to slavery was never particularly strong in Africa itself, where slavery is slowly being eradicated only in our time. One can suspect that slavery would have remained common in most African kingdoms until this day: what crushed slavery in Africa was that all those African kingdoms became colonies of western European countries that (for one reason or another) eventually decided to outlaw slavery. When, in the 1960s, those African colonies regained their independence, numerous cases of slavery resurfaced. And countless African dictators behaved in a way that makes a slave owner look like a saint. Given the evidence that this kind of slavery was practiced by some Africans before it was practiced by some Americans, that it was abolished by all whites and not by some Africans, and that some Africans resumed it the moment they could, why would one keep blaming the USA but never blame, say, Ghana or the Congo?

The more we study it, the less blame we have to put on the USA for the slave trade with black Africa: it was pioneered by the Arabs, its economic mechanism was invented by the Italians and the Portuguese, it was mostly run by western Europeans, and it was conducted with the full cooperation of many African kings. The USA fostered free criticism of the phenomenon: no such criticism was allowed in the Muslim and Christian nations that started trading goods for slaves, and no such criticism was allowed in the African nations that started selling their own people (and, even today, no such criticism is allowed within the Arab world).

Today it is politically correct to blame some European empires and the USA for slavery (forgetting that it was practiced by everybody since prehistoric times).

But I rarely read the other side of the story: that the nations who were the first to develop a repulsion for slavery and eventually abolish slavery were precisely those countries (especially Britain and the USA). In 1787 the Society for Effecting the Abolition of the Slave Trade was founded in England: it was the first society anywhere in the world opposed to slavery. In 1792 English prime minister William Pitt called publicly for the end of the slave trade: it was the first time in history (anywhere in the world) that the ruler of a country had called for the abolition of slavery. No African king and emperor had ever done so. As Dinesh D'Souza wrote, "What is uniquely Western is not slavery but the movement to abolish slavery".

To be completely fair, what was also unique about the western slave trade is the scale (the millions shipped to another continent in a relatively short period of time), and, of course, that it eventually became a racist affair, discriminating blacks, whereas previous slave trades had not discriminated based on the color of the skin. What is unique about the USA, in particular, is the unfair treatment that blacks received AFTER emancipation, which is, after all, the real source of the whole controversy, because, otherwise, just about everybody on this planet could claim to be the descendant of an ancient slave).

That does not mean that western slave traders were justified in what they did, but placing all the blame on them is a way to absolve all the others.

Also, it is worth noting that the death rate among the white crews of the slave ships (20-25%) was higher than the rate among black slaves (15%) because slaves were more valuable than sailors but nobody has written books and filmed epics

about those sailors (often unwillingly enrolled or even kidnapped in ports around Europe when they were drunk).

To this day, too many Africans, Arabs and Europeans believe that the African slave trade was an USA aberration, not their own invention.

By the time the slave trade was abolished in the West, there were many more slaves in Africa (black slaves of black owners) than in the Americas.

Marxist Generals - Ethnic Soldiers - White Victims - Worldwide



William Wilberforce

On Friday July 26th 1833 as he lay on his deathbed Wilberforce exclaimed: "Thank God that I have lived to witness the day in which England is willing to give £20 million for the abolishment of slavery." (What would that be worth today ?)

He died three days later.

The Slavery Abolition Bill 1833 passed through the House of Lords, it received the Royal Assent (which means it became law) on 29 August 1833 and came into force on 1 August 1834.

On that date slavery was abolished throughout the vast British Empire.

The Act automatically applied as new possessions (principally in Africa) subsequently became part of the British Empire.

To know who rules over you.

Simply find out who it is that you are not allowed to criticise.

.....Voltaire

We, as White people, have been GAGGED!! Then bullied, insulted, demonised, and provoked, until we object and complain. We then get called *dirty names* like Nazi, Racist, White Extremist, etc, etc.

Our weak & corrupt Lib/Lab/Con Politicians are the problem. As of Jan 2021, the UK elections are years away. Check out Populism, and Nationalism ASAP. Become "WHITE WOKE" & Push Back.

Do it today, NOW!

Alex Haley - Roots

Fraudster, Liar, Plagiariser

From The BNP Website On 24th March 2007

From http://www.bnp.org.uk/news_detail.php?newsId=1426

Slave trade is real history but Haley's book is a piece of imaginative fiction

The BBC has been indulging in a bit of "whitey" bashing again today, focusing on the marking of the slave trade which was abolished throughout the British Empire and reminding listeners to Radio 4 that the evil white Europeans and white Americans are collectively guilty of enslaving the poor down-trodden Africans. The indisputable facts that various African tribes were enslaving one another centuries before a single western European set foot in West Africa and that slavery continues today without the involvement of a single white European were not aired in the programme "Roots" broadcast earlier today. Another fact that wasn't mentioned was that the book "Roots", on which the 1977 tv series was based, was penned by one of the biggest fraudsters in American literary history and the work itself less of a milestone in raising awareness of Black American history than a plagiarised piece of fiction. Alex Haley claimed his work was based on twelve years of research spanning two continents and over two hundred years of history. The reality was less of a heroic piece of study and more of an act of deceit which duped millions in the UK and America.

Financial settlement

Haley himself was forced to acknowledge, a large section of his book - including the plot, main character and scores of whole passages - was lifted from "The African," a 1967 novel by white author Harold (Hal) Courlander. Haley was forced to pay the author \$650,000 in damages in an out-of-court settlement after a plagiarism trial in 1978, that's about \$2million in today's money. Plagiarism isn't the only issue which blights the success of the television series. Thanks to investigative American journalist Philip Nobile Haley's alleged history of the book was a near-total invention. Nobile conducted a study of Haley's private papers shortly before they were auctioned off. "Virtually every genealogical claim in Haley's story was false," Nobile has written. None of Haley's early writing contains any reference to his mythic ancestor, "the African" named Kunta Kinte. Indeed, Haley's later notes give his family name as "Kante," not "Kinte."

Threats

And a long-suppressed tape of the famous session in which Haley "found" Kunta Kinte through the recitation of an African "griot" proves that, as a BBC producer James Kent noted, "the villagers [were] threatened by members of Haley's party. These turn out to be senior (Gambian) government officials desperate to ensure that things go smoothly." Haley, added Kent, "specifically asks for a story that will fit his predetermined American narrative." Historical experts who checked Haley's

genealogical research discovered that, as one put it, "Haley got everything wrong in his pre-Civil War lineage and none of his plantation ancestors existed; 182 pages have no basis in fact." The tv series, like the book was presented as factual history, albeit with fictional embellishments. Haley himself claimed that the details came from his family's oral history and had been corroborated by outside documents. Viewers were duped- big style but a strange twist in all this - the BBC itself produced a documentary expose of Haley's work in 1996 (The Roots of Alex Haley, Documentary. Directed by James Kent. BBC Bookmark, 1996) which has been banned by U.S. television networks - yet the very same broadcaster chose to ignore that important fact in today's programme in a prime example of how the State channel continues to rewrite history in a classical Orwellian 1984 manner.

Marxist Generals - Ethnic Soldiers - White Victims - Worldwide



Hal (Harold) Courlander

Books by Hal Courlander

<https://www.thriftbooks.com/a/harold-courlander/239547>



William Wilberforce

On Friday July 26th 1833 as he lay on his deathbed Wilberforce exclaimed: "Thank God that I have lived to witness the day in which England is willing to give £20 million for the abolishment of slavery." (What would that be worth today ?) He died three days later.

The Slavery Abolition Bill 1833 passed through the House of Lords, it received the Royal Assent (which means it became law) on 29 August 1833 and came into force on 1 August 1834. On that date slavery was abolished throughout the vast British Empire. The Act automatically applied as new possessions (principally in Africa) subsequently became part of the British Empire.

To know who rules over you. Simply find out who it is that you are not allowed to criticise.Voltaire

We, as White people, have been GAGGED!! Then bullied, insulted, demonised, and provoked, until we object and complain. We then get called *dirty names* like Nazi, Racist, White Extremist, etc, etc.

Our weak & corrupt Lib/Lab/Con Politicians are the problem. As of Jan 2021, the UK elections are years away. Check out Populism, and Nationalism ASAP. Become "WHITE WOKE" & Push Back.

Do it today, NOW!

Amistad Slave Ship: Cinque, Was Himself A Slave Trader

For 20 interminable minutes in "Amistad," Steven Spielberg lingers over scenes of whites torturing black slaves with the lurid attention of a pornographer.

From <http://www.hoffman-info.com>

The rest of the film--the fine courtroom oratory, the black & white solidarity, abolitionist "idealism"--is all window-dressing to persuade the liberal intellectuals in the theatre audience to feel good about Spielberg's anti-white horrorshow. But the core message of "Amistad" can be summed up in two words from the ghetto: Hate Whitey.

With Amistad, Steven Spielberg, hailed as a latter-day secular Jewish saint, has set the cause of harmonious race relations back decades.

He perpetrated a similar ruse in "Schindler's List." His stratagem in that flick was to demonize the German people but to do so within the framework of a humanist gloss. So the putative hero, Schindler, is a German and nominally, a Christian. From there, Spielberg was able to mount a demonic stereotype that no one but a Jew could get away with in these hyper-sensitive, "human rights" times. Spielberg stereotyped the entire German army--every one, to a man--as black-jacketed minions of Satan.

Amistad is equally pathological. If we shed the window-dressing, it's a sado-masochist ritual. Sadistic whites torture noble blacks. Noble blacks retaliate, and we watch them dismember trembling and quivering white villains who are shown on their knees begging for mercy.

An honest film about slavery is needed, but Spielberg will never be the one to furnish it. Such a film would entail three components, all of them forming the critical element missing from Amistad--context.

1. Cameras would detail the horrors of the black-on-black slave trade on the Dark Continent itself, where black chiefs captured, shackled, tormented and sometimes massacred their fellow Africans. The survivors of this terrible ordeal were sold to the Europeans.

2. Cameras would detail the horrors of the white on white slave trade emanating from Britain. Court historians like to pretend that the phenomenon of the "press gang" (armed men who kidnapped whites by force) was chiefly an activity of the British navy. In fact, the naval press gang was made possible by the precedent established by gangs of 17th century kidnappers (originally called "kid nabbers") who stole ("nabbed") children (kids) by guile or with a blow on the head, for shipment to the colonies for sale as slave labor. The very word kidnapping has its origin in this white enslavement.

In the 18th and 19th centuries, whites were whipped to death in the Continental Army and the US Navy (where the lethal practice was known as "flogging through the fleet"). This was an age of cruelty and to suggest that only blacks experienced cruel treatment or that they were singled out for it, is the sort of subversive mendacity that can only heighten black racial paranoia.

3. Where in 19th century Africa could a slave receive the kind of hearing that white Christians gave Joseph Cinque and his little band? Ours was an extraordinary civilization, deeply flawed, but incomparably just and humane compared with what prevailed in Asia and Africa at the time.

Moreover, Spielberg's Amistad hoax is defeated by a solitary historical fact: Joseph Cinque was himself a slave trader, selling his fellow blacks into this horror after he himself was set free by a US court.

Amistad producer Debbie Allen calls this destabilizing fact a "rumor." She'd better. If the thinking public, black and white, discover that "noble" Cinque later sold his own people in the very manner he condemned, then there will be a second mutiny, this time against Spielberg and his shameless hoaxing. Here is Samuel Eliot Morrison, one of the most distinguished of American historians, writing in his "Oxford History of the American People," (New York: Oxford Univeristy Press, 1965), p. 520:

"The most famous case involving slavery, until eclipsed by Dred Scott's, was that of the Amistad in 1839. She was a Spanish slave ship carrying 53 newly imported Negroes who were being moved from Havana to another Cuban port. Under the leadership of an upstanding Negro named Cinqué, they mutinied and killed captain and crew. Then, ignorant of navigation, they had to rely on a white man whom they had spared to sail the ship.

"He stealthily steered north, the Amistad was picked up off Long Island by a United States warship, taken into New Haven, and with her cargo placed in charge of the federal marshal. Then what a legal hassle! Spain demanded that the slaves be given up to be tried for piracy, and President Van Buren attempted to do so but did not quite dare.

"Lewis Tappan and Roger Sherman Baldwin, a Connecticut abolitionist, undertook to free them by legal process, and the case was appealed to the Supreme Court. John Quincy Adams, persuaded to act as their attorney, argued that the Negroes be freed, on the ground that the slave trade was illegal both by American and Spanish law, and that mankind had a natural right to freedom.

"The court with a majority of Southerners, was so impressed by the old statesman's eloquence that it ordered Cinqué and the other Negroes set free, and they were returned to Africa.



William Wilberforce

On Friday July 26th 1833 as he lay on his deathbed Wilberforce exclaimed: "Thank God that I have lived to witness the day in which England is willing to give £20 million for the abolishment of slavery." (What would that be worth today ?)

He died three days later.

The Slavery Abolition Bill 1833 passed through the House of Lords, it received the Royal Assent (which means it became law) on 29 August 1833 and came into force on 1 August 1834.

On that date slavery was abolished throughout the vast British Empire.

The Act automatically applied as new possessions (principally in Africa) subsequently became part of the British Empire.

To know who rules over you. Simply find out who it is that you are not allowed to criticise.Voltaire

We, as White people, have been GAGGED!! Then bullied, insulted, demonised, and provoked, until we object and complain. We then get called *dirty names* like Nazi, Racist, White Extremist, etc, etc.

Our weak & corrupt Lib/Lab/Con Politicians are the problem. As of Jan 2021, the UK elections are years away. Check out Populism, and Nationalism ASAP. Become "WHITE WOKE" & Push Back.

Do it today, NOW!

The ironic epilogue is that Cinqué, once home, set himself up as a slave trader."

(End quotation from historian Samuel Eliot Morrison)

Any time German-Americans or white Southerners try to advance a truthful historical thesis that happens to be revisionist we are wrongly smeared as being "just like Nazi propagandist Joseph Goebbels." Now that we know Hollywood director Steven Spielberg is advancing fraud in Amistad and calling it history, he ought to be rightly compared with another highly skilled Jewish illusionist, next to whom "Jupp" was a paragon of veracity.

Spielberg's Amistad movie is reminiscent of nothing less than the poisonous Communist lies of Stalin's propagandist, Ilya Ehrenburg.

--Michael A. Hoffman II Copyright©1997

To view "Black" novelist Barbara Chase-Riboud's lawsuit against Spielberg concerning his theft of her thunder (and her made-up story), locate Chase-Riboud v. Dreamworks, Inc. at: <http://www.law.cornell.edu/amistad/complaint.html>



William Wilberforce

On Friday July 26th 1833 as he lay on his deathbed Wilberforce exclaimed: "Thank God that I have lived to witness the day in which England is willing to give £20 million for the abolishment of slavery." (What would that be worth today ?)

He died three days later.

The Slavery Abolition Bill 1833 passed through the House of Lords, it received the Royal Assent (which means it became law) on 29 August 1833 and came into force on 1 August 1834. On that date slavery was abolished throughout the vast British Empire.

The Act automatically applied as new possessions (principally in Africa) subsequently became part of the British Empire.

To know who rules over you. Simply find out who it is that you are not allowed to criticise.Voltaire

We, as White people, have been GAGGED!! Then bullied, insulted, demonised, and provoked, until we object and complain. We then get called *dirty names* like Nazi, Racist, White Extremist, etc, etc.

Our weak & corrupt Lib/Lab/Con Politicians are the problem. As of Jan 2021, the UK elections are years away. Check out Populism, and Nationalism ASAP. Become "WHITE WOKE" & Push Back.

Do it today, NOW!



William Wilberforce

On Friday July 26th 1833 as he lay on his deathbed Wilberforce exclaimed: "Thank God that I have lived to witness the day in which England is willing to give £20 million for the abolishment of slavery." (What would that be worth today ?)

He died three days later.

The Slavery Abolition Bill 1833 passed through the House of Lords, it received the Royal Assent (which means it became law) on 29 August 1833 and came into force on 1 August 1834. On that date slavery was abolished throughout the vast British Empire.

The Act automatically applied as new possessions (principally in Africa) subsequently became part of the British Empire.

To know who rules over you. Simply find out who it is that you are not allowed to criticise.Voltaire

We, as White people, have been GAGGED!! Then bullied, insulted, demonised, and provoked, until we object and complain. We then get called *dirty names* like Nazi, Racist, White Extremist, etc, etc.

Our weak & corrupt Lib/Lab/Con Politicians are the problem. As of Jan 2021, the UK elections are years away. Check out Populism, and Nationalism ASAP. Become "WHITE WOKE" & Push Back.

Do it today, NOW!

Now, the news story I mentioned appeared because the London-based group Anti-Slavery International has just released a report detailing the latest facts and figures for child slavery in West Africa. Do you wonder why you Don't see more news about the slave trade? Do you wonder why the New York Times, the Washington Post, the Wall Street Journal, and the major television news networks have virtually nothing to say about it? Can you imagine the outrage you would see in these controlled media, day after day and week after week, if White people were behind this trade in Black children?

Of course, you can! But news about Blacks in Africa, behaving the way Blacks always have behaved, whether it is buying and selling child slaves in Nigeria or engaging in ritual cannibalism in Liberia or "necklacing" accused witches in South Africa, is news which doesn't fit and is therefore deemed not newsworthy by the masters of the controlled media.

In fact, the media masters consider such news positively harmful, because it conflicts with the image they have built in the minds of the White public: an image of virtuous, peaceable, freedom-loving, industrious, sensitive, and creative Blacks, essentially noble Blacks, who have failed to rise to the cultural level of Europe and America only because they have been enslaved and exploited by cruel, greedy White supremacists. It's important to maintain this deceptive image, because it reinforces the sense of White racial guilt; it helps keep Whites convinced that they owe something to non-Whites, that they must never think of their own racial interests or feel any sense of White racial solidarity, because that can only lead to terrible things like slavery and the oppression of noble Blacks.

Actually, the media masters have quite different reasons for wanting to keep White thinking about racial matters confused. If Whites ever begin thinking racially, ever begin thinking in terms of their collective racial interests, the way the media masters do, they will be much more difficult to control -- and the media masters themselves will be in grave danger. So That's why we hear and see so much in the media about the evils of White racism, and the need for the government to crack down on what the media bosses call "hate," and the importance of giving the poor Blacks a few special advantages like affirmative action to make up for the way we mistreated them in the past -- and, ahem, the correctness of pressuring the Swiss people into coughing up as much gold as another poor, oppressed minority group demands. And It's also why we almost never see or hear anything about Black slavery in Africa today -- and, more generally, about what all of these wonderful minorities with which we are blessed are actually like and the way in which they really behave when left to themselves.

I've done a lot of thinking about this problem of the Jewish control of our news and entertainment media, and I've probably talked more about it on these American Dissident Voices broadcasts than any other problem we're facing as a people. That's because It's the most important problem we're facing. It's the key to

I have before me a news story written by a correspondent for the London Daily Telegraph.

From <https://nationalvanguard.org>

I have before me a news story written by a correspondent for the London Daily Telegraph. It's a story about the flourishing child-slavery business in West Africa: in countries like Nigeria, Togo, Benin, and Gabon. Businessmen in the coastal cities send buyers into the interior with buses, where they collect surplus children, in the seven- to 15-year-old age range, and bring them back in groups of 50 to 100 -- in other words, a bus load -- to the slave markets on the coast. Typically the buyers pay parents anywhere from 10 to 30 dollars per child. In some areas, they simply bribe local officials to look the other way and kidnap the children.

Once in the coastal cities, the children are housed in large, supermarket-style buildings where shoppers can stroll through, select the children they want to buy, and pay for their merchandise at the door as they leave. Some of the purchasers send the children out on the streets to work as prostitutes. Others use them as house servants or as factory workers.

This is not a small-time thing or an occasional thing. This is a thriving business involving thousands of children bought and sold every year in dozens of slave markets in West African cities, in the region which used to be known as the "slave coast," because That's where the slave dealers, during the 18th and early 19th centuries, would buy ship loads of slaves to take to the West Indies and the Americas for plantation work. After slavery was outlawed in Europe and America, it continued as an ongoing institution in Africa, just as it had for countless centuries before White men began buying African slaves.

The only reason Europeans and White Americans ever hear anything about this ongoing African slave trade is that there are a few tender-hearted White groups, such as Amnesty International and Anti-Slavery International, whose sensibilities are offended by this sort of thing. These groups try to arouse public opinion in America and Europe against slavery.

They also work through politicians, trying to persuade them to put anti-slavery amendments into aid agreements with African countries. As a result of such aid-agreement amendments most African countries recently have gone through the motions of enacting legislation outlawing slavery. All this means in practice is that the slave dealers must pay bribes to the politicians or the police in order to avoid interference with their business.

all of our other problems. It's the one problem we must overcome if our people are to survive.

Let's look today at a couple of aspects of this problem of Jewish media control that I haven't discussed much in the past. What I have discussed often before is the fact that most people Aren't really rational in the formation of their opinions and attitudes. They Don't believe what makes the most sense. They Don't believe what they see the best evidence for. They believe what is fashionable. They believe whatever they think other people believe. And so the task of the mass media is not primarily to present either factual or contrived evidence for a particular point of view they want the public to adopt; instead it is simply to convince the public that this point of view is fashionable: that it is the point of view most other people already have. And the media do this convincing primarily with advertising and with entertainment: they show fashionable actors expressing the opinions they want the viewers to adopt. Sometimes they use news for the same purpose: they'll sample the reactions of people on the street to some event in the news and then select those reactions for broadcast or publication which match the reaction they want the public to have. But the main task of the news media is to screen out facts which Don't fit and present only those facts which seem compatible with the opinions the media are promoting.

And that technique works quite well with most people. But there are many White Americans who are able to think for themselves, who are able to entertain even unfashionable ideas, if That's where the evidence points. Why Don't we hear more of these Americans speaking out? Why do so many of them just go along with the falsehoods and deceptions of the controlled media?

I believe that a full answer to this question has three parts. In the first place, these people able to think for themselves tend to be more successful economically and socially than the average, because they're smarter than the average. They tend to belong to the upper strata of our society, strata whose inhabitants are cushioned against many of the harsher realities of what is happening to our society -- and who live in an environment where politeness is especially valued. They Don't want to be rude. They Don't want to be offensive. To point out too loudly the inadequacies of Blacks would be considered a bit déclassé.

In the second place many Whites believe that we should preserve the peace at all costs. They place a very high value on maintaining social tranquillity. They know how easily some minorities take offense and how violent and destructive they can become. They know that if a White policeman has to tap a Black with his nightstick during an arrest, his fellow Blacks may stage a three-day riot and burn the whole town to the ground. And so these peace-loving folks are inclined to tread very softly and leave their nightsticks at home. They'd rather see us White rabble-rousers restrained than give us an opportunity to stir up trouble. After all, they think, as bad as the racial situation is, we have to learn to live with it. We may not like it, but there's nothing we can do about it -- nothing, that is, except things that

inevitably would entail a great deal of conflict, violence, and bloodshed, and That's just too terrible to contemplate. Our people, unfortunately, have lost a lot of their stomach for that sort of thing over the past couple of hundred years.

And, as I said, these are folks who already have a reasonable understanding of the facts. They're not taken in by any egalitarian myths. With them It's a problem of values, of priorities. Keeping the peace and avoiding violence is the most important thing to them. About the only way you can persuade them to take a stand for their people is convince them by demonstration that Blacks are not the only ones who can raise hell, and that simply being polite will not permit them to escape unscathed and avoid violence to their own persons.

Finally, I believe that for many independent-minded people the problem is not being able to see the forest for the trees. What they see is that there are many individual Blacks who are intelligent, there are many moral Blacks, many industrious and self-disciplined Blacks, and many individual Blacks who are able to adapt quite successfully and even constructively to a civilized, European society. And they also see that there are many White people who are stupid, lazy, immoral, and undisciplined and are a burden on our society. These independent-minded people are focused on individual Blacks and individual Whites, and the conclusion they reach is that there are some good and useful people of all races in our society and some bad and useless people of all races.

What these independent-minded people fail to do is back off a bit and look at races as a whole. What they fail to understand is that the problem we must deal with is not the quality of the individual Negro who is living next door, or even the effect that minorities are having on our neighborhood. The problem is what Blacks as a race -- or what non-Whites generally -- are doing to our society and to our race by living among us. And it is quite clear, indisputably clear, that what they are doing as a race, as a whole, is not good. They are destroying our society and our race. That's the problem we must deal with, and all considerations of individuals become wholly insignificant in comparison.

Now, I know That's hard for some people to grasp. I know that it took me a while to get my own thinking straightened out. I began life more or less as a libertarian, and my primary concern was that the government not mess with me personally -- and more generally that people be permitted to do whatever they want to do as individuals. I didn't think much about the cumulative effects of individual actions and individual qualities on the society in which I was living. But as these cumulative effects began being really noticeable in the 1960s, I had to start thinking about them. I believe that all of us need to think about them.

We need to understand that every race encompasses individuals with a range of characteristics, with each characteristic distributed about some average value in a more or less bell-shaped curve. When we want to think about the effects of mixing



William Wilberforce

On Friday July 26th 1833 as he lay on his deathbed Wilberforce exclaimed: "Thank God that I have lived to witness the day in which England is willing to give £20 million for the abolishment of slavery." (What would that be worth today ?) He died three days later.

The Slavery Abolition Bill 1833 passed through the House of Lords, it received the Royal Assent (which means it became law) on 29 August 1833 and came into force on 1 August 1834. On that date slavery was abolished throughout the vast British Empire. The Act automatically applied as new possessions (principally in Africa) subsequently became part of the British Empire.

To know who rules over you. Simply find out who it is that you are not allowed to criticise.Voltaire

We, as White people, have been GAGGED!! Then bullied, insulted, demonised, and provoked, until we object and complain. We then get called *dirty names* like Nazi, Racist, White Extremist, etc, etc.

Our weak & corrupt Lib/Lab/Con Politicians are the problem. As of Jan 2021, the UK elections are years away. Check out Populism, and Nationalism ASAP. Become "WHITE WOKE" & Push Back.

Do it today, NOW!



William Wilberforce

On Friday July 26th 1833 as he lay on his deathbed Wilberforce exclaimed: "Thank God that I have lived to witness the day in which England is willing to give £20 million for the abolishment of slavery." (What would that be worth today ?)

He died three days later.

The Slavery Abolition Bill 1833 passed through the House of Lords, it received the Royal Assent (which means it became law) on 29 August 1833 and came into force on 1 August 1834. On that date slavery was abolished throughout the vast British Empire.

The Act automatically applied as new possessions (principally in Africa) subsequently became part of the British Empire.

To know who rules over you. Simply find out who it is that you are not allowed to criticise.Voltaire

We, as White people, have been GAGGED!! Then bullied, insulted, demonised, and provoked, until we object and complain. We then get called *dirty names* like Nazi, Racist, White Extremist, etc, etc.

Our weak & corrupt Lib/Lab/Con Politicians are the problem. As of Jan 2021, the UK elections are years away. Check out Populism, and Nationalism ASAP. Become "WHITE WOKE" & Push Back.

Do it today, NOW!

media to encourage miscegenation; and finally, when they make the claim that there really is no such thing as race, that the whole concept of race is meaningless. Yes, we need to understand what these Jewish media bosses are up to. We need to understand the overall consequences to our people of permitting them to live among us.

Finally, let me leave you with this thought. If the idea of inferiority and superiority bothers you, if you Don't like the idea of categorizing Black society in Nigeria or Uganda, with its enduring institution of slavery, as inferior to White society, just think of it as different. And just realize that when people from a different race are mixed with ours, we will become different. We will lose our racial distinctness, our very ability to think of ourselves as a race. That is why I am opposed not only to the presence of Blacks and Jews in our society, but even to the large-scale presence of races I respect, such as the Japanese. Mixing leads to the loss of distinctness, to the loss of identity. And the loss of identity leads inevitably to death.

Think about it.



two races together in a society, it is these average values we must consider, not individuals. For example, there are smart Blacks and stupid Whites -- a lot more of the latter these days than in the past, it seems -- but the average intelligence for Blacks in the United States is between 15 and 20 IQ points below the average for Whites. That's more than enough to make the difference between being able to sustain a modern, civilized society and not being able to keep it from sliding back into the jungle, the way every Black country in Africa for which Whites built a civilized infrastructure began sliding back into the jungle as soon as the Whites relinquished control to the Blacks during the decolonization period after the Second World War.

More than that, the rare individuals who have the special abilities required to build a civilization, not just sustain one, are way out on the high side of the bell curve -- far enough out, in fact, that the Black bell curve has for all practical purposes gone to zero. Which is to say that if on the White bell curve for an average population of one million Whites there are 100 who qualify as civilization builders, as true innovators, then on a bell curve for one million Blacks the number of individuals who qualify as civilization builders is somewhere between zero and one.

These are the things that people who are able to think for themselves need to consider. They need to consider the overall effects of allowing large numbers of Blacks and other non-Whites to live among us. They need to consider the ultimate consequences of such a policy. They need to realize that as races with lower standards of performance than ours mix with us, they inevitably will pull down the overall standards for our society. Eventually they will pull us down to the level where we cannot compete effectively with other societies which have maintained their own standards.

Our independent-minded people need to think clearly about the ways in which our society already has been degraded by permitting larger and larger numbers of non-Whites to live among us. They need to look at our school problem and our crime problem and our drug problem and to understand that these are consequences of our failing to maintain a White society, and that we are suffering these consequences regardless of the fact that there are many individual Blacks who cannot be blamed for these problems. They need to understand that it is Blacks collectively, Blacks as a race, who are pulling our society down.

Our people also need to understand the true motivations of the media bosses when they respond to these problems by trying to obscure the problems and confuse us about them: for example, by campaigning against IQ testing -- or any testing of people which distinguishes them or ranks them according to ability and thereby reveals the fact of racial inequality -- and at the same time by trying to convince us that there is some mysterious benefit to be gained by having more racial diversity in our society; when they deliberately try to make us feel a sense of racial guilt by blaming Black slavery on Whites; when they deliberately use their

On Blaming White Folk For Slavery

It takes two parties for there to be a business transaction, a seller and a buyer.

From <http://www.nigeriavillagesquare.com>

It takes two parties for there to be a business transaction, a seller and a buyer. Africans sold their people and Arabs and Europeans bought them and used them as slaves. Most people agree that the trafficking in human beings was wrong; if so, all parties to it were wrong. White folk were guilty for buying and abusing African slaves; Arabs were guilty for buying and abusing African slaves. By the same token, the Africans that sold their people into slavery were guilty for doing so.

In a manner of speaking, it is a greater sin to sell ones people than to buy those one considers not ones people. Arabs and whites did not see Africans as their people and one can understand them buying and using them as slaves without feeling guilty. On the other hand, the Africans that sold their people knew that they were selling their people and, as such, were guiltier for doing so! It takes two to engage in business transactions but Africans somehow come to believe that only white folk are guilty for slavery. Indeed, they do not even blame Arabs for slavery; they only blame Europeans. Actually, Arabs began buying African slaves before whites did, from around 900 AD, and are still doing so today in Sudan and Mauritania. Europeans got into the act of buying African slaves from around 1500 AD, six hundred years after the Arabs did!

Africans do not blame Arabs, the greater evil participants in the sordid business of enslaving human beings, instead, they blame Europeans. Europeans bought Africans from 1500 to 1900 AD. And they learned to do so by seeing Arabs using African slaves in their Indian Ocean plantations. When the Portuguese got to Brazil in 1500 they tried to use native Indians to do their plantation work for them and the later either died or fled into the forest. The Portuguese remembered that on their way to India they had seen Arabs using African slaves in their plantations and came back to West Africa to buy African slaves. That is to say that Europeans imitated Arabs in enslaving Africans, yet Africans blame Europeans not the original enslavers, Arabs!

Europeans enslaved Africans for about four hundred years. Arabs enslaved Africans for over one thousand years (900-1900 AD). Given the length of Arab enslavement of Africans it is astonishing for Africans to blame whites, not Arabs, and for Africans not to blame Africans for their role in selling their people? I think that what we have here is the original 419 Scamming. Apparently, Africans discovered that European Christians are prone to feeling guilty for their wrongs so they decided to manipulate that guilt feeling by blaming them for their role in slavery. Apparently, Muslims do not feel guilty for slavery? Certainly, the Arabs that I know

do not feel guilty for their role in buying Africans slaves. Therefore, Africans did not see any need to blame Arabs.

For manipulation of guilt to work the person you want to make to feel guilty must be willing to accept the guilt that you are assigning to him. Apparently, Africans could not assign guilt to Arabs so they did not blame Arabs; they know that Christians are prone to guilt feeling so they blame European Christians and White Americans for buying African slaves hoping that in their accepting guilt they would be manipulated into exonerating Africans role in slavery and paying reparations to Africans! This is disingenuous behavior! What is going on here is that African scam artists calling themselves scholars are setting white folk up to manipulate them, to relieve them of their money, as Nigerian 419 advance fee scam artists set white folk up to relieve them of their money!

Thus, African criminal leaders who exist to relieve their people of their money ask Europe and North America to pay reparation to Africa for slavery!

The criminals who sold their people into slavery do not feel guilty for their criminal action and further more attempt to make other persons to feel guilty for their behaviors and pay them for it. This is typical sociopathic thinking and behavior, behavior that shows lack of guilt and remorse feeling and heartless exploitation of other persons.

African leaders, apparently, do not feel guilty for selling their people in the past and in the present for robbing their people down.

What is the African leader but a criminal in politics? These criminals that ought to be in jail want other people to pay them reparation! This is the original scamming behavior. Apparently, many Africans have been scam artists for far longer than one thought. One thought that 419 advance fee scamming began in contemporary Nigeria; apparently, it has been a pattern of these people's behaviors for a long time!

In my view, Europeans and white Americans should pay reparation to black Americans, to ex slaves. But so must Arabs and Africans.

African countries sold their people and should therefore pay reparations to black Americans. At least, five percent of African countries annual budgets ought to be given to blacks in the Diaspora, to make amends for the sin of selling them. This ought to be done for, at least, thirty four years, a generation.

Africans from Africa calling for white folk to pay them reparation for slavery are scam artists and ought not to be listened to or paid. They are criminals who do not feel guilty for selling their people and therefore ought to be punished rather than rewarded for their criminal activities. To pay them for their crime against their own people is treating them like children and make excuses for their criminal acts and in so doing perpetuate their tendency to criminal behavior.

White folk should not let these scam artists to make them feel guilty and allow themselves to be swindled out of their money. These thieves would say that they



William Wilberforce

On Friday July 26th 1833 as he lay on his deathbed Wilberforce exclaimed: "Thank God that I have lived to witness the day in which England is willing to give £20 million for the abolishment of slavery." (What would that be worth today ?)

He died three days later.

The Slavery Abolition Bill 1833 passed through the House of Lords, it received the Royal Assent (which means it became law) on 29 August 1833 and came into force on 1 August 1834. On that date slavery was abolished throughout the vast British Empire. The Act automatically applied as new possessions (principally in Africa) subsequently became part of the British Empire.

To know who rules over you. Simply find out who it is that you are not allowed to criticise.Voltaire

We, as White people, have been GAGGED!! Then bullied, insulted, demonised, and provoked, until we object and complain. We then get called *dirty names* like Nazi, Racist, White Extremist, etc, etc.

Our weak & corrupt Lib/Lab/Con Politicians are the problem. As of Jan 2021, the UK elections are years away. Check out Populism, and Nationalism ASAP. Become "WHITE WOKE" & Push Back.

Do it today, NOW!



William Wilberforce

On Friday July 26th 1833 as he lay on his deathbed Wilberforce exclaimed: "Thank God that I have lived to witness the day in which England is willing to give £20 million for the abolishment of slavery." (What would that be worth today ?) He died three days later.

The Slavery Abolition Bill 1833 passed through the House of Lords, it received the Royal Assent (which means it became law) on 29 August 1833 and came into force on 1 August 1834. On that date slavery was abolished throughout the vast British Empire. The Act automatically applied as new possessions (principally in Africa) subsequently became part of the British Empire.

To know who rules over you. Simply find out who it is that you are not allowed to criticise.Voltaire

We, as White people, have been GAGGED!! Then bullied, insulted, demonised, and provoked, until we object and complain. We then get called *dirty names* like Nazi, Racist, White Extremist, etc, etc.

Our weak & corrupt Lib/Lab/Con Politicians are the problem. As of Jan 2021, the UK elections are years away. Check out Populism, and Nationalism ASAP. Become "WHITE WOKE" & Push Back.

Do it today, NOW!

would use that money to help their people but would instead redirect it to their pockets and squander it in riotous living; not a penny they received from reparation would go to help their people. Who has ever heard of African leaders devoting their lives to helping their people, serving their people? No, they seem to exist to steal from their people.

For the purpose of driving my point that Africans participated in slavery home here is how the slavery business worked in my part of Africa, how some African criminals captured and sold their people and pretend to be innocent persons!

I am from Umuohiagu (where Owerri airport is). Until 1902 when Frederick Lugard stormed the market of Owere (which he mispronounced as Owerri hence the word Owerri) where slaves were sold, our people were routinely selling themselves into slavery.

Abam and Ariba (Igbo clans) and other such folk roamed our villages capturing children and women and marching them to the Coast and selling them to white men.

Our people organized themselves into age mate groups, from about age fourteen up. These age mates acted as militia and paraded the village looking for slave kidnapers. They walked with children to the village stream and walked women to their farms to protect them from been kidnapped by slavers who lurked in the bushes kidnapping their fellow Igbos and selling them to white men!

Slaves were sold at Owere market and from there marched to Igwe Ocha (Port Harcourt) and then to Bonny where they were sold to the Portuguese, and later to other Europeans.

In our town an Aro priest was stationed; he urged the town folk to bring their conflicts to him to settle for them. Those who lost their cases were told to appeal them to Arochukwu itself. There, they were put through a tunnel and if they did not come out it was said that the Long Juju of Arochukwu had found them guilty and taken them. In actual fact, they were marched to the other end of the tunnel and sold to Efik slavers who marched them to Calaba and sold them to white men.

Lugard, a young captain in the British army, hired by the Royal Niger Company, heard about these nefarious activities and in 1902 used his mostly Hausa soldiers, called West African Frontier Army, to storm and destroy the so-called Arochukwu Oracle and thereafter marched through Igbo villages including destroying the slave market at Owere and thereafter decided to make Owerri the headquarters of his Owerri province and marched through my village (in his words, "pacifying the savages of the lower Niger" ...see his Memoir, The Dual Mandate).

The point here is that Africans were selling their people to whites. Whites did not go into interior Africa to go buy Africans. They stayed at the coast and arranged with coastal Africans, in the case of Igbos, Efiks, Ijaws, to go inside the interior and capture and or buy and bring Africans to be sold to them.

The Aro arranged with the Efik (around 1600 AD) to bring Igbo slaves to them to be

sold to whites, and used their phony religion to enact their evil; they employed the Abam and Ariba as mercenaries to carry out their nefarious business of capturing and selling their people.

Would any rational person say that what Africans did was right? Of course it was evil. By the same token, whites and Arabs committed evil in buying and enslaving Africans. If we must blame whites for their enslavement of our people in the Americas, and we must, we must also blame our people for selling their people to whites. What is good for the goose is good for the gander. I am not exonerating any one. It seems to me that Africans, Arabs and Europeans were all culprit in selling and enslaving our people.

Africans did not only sell their people to Arabs and whites but to themselves. In Alaigbo we had what was called Ohu. Here, poor folk sold themselves to rich folk for a period of time until they could pay off the money the buyers paid for them, which was almost always never, making them perpetual ohus (indentured servants).

We also had osus (slaves). Osus were folk sold to high priests and used for the high priests farm work. Later, the osu phenomenon was perverted into the belief that osus were god's slaves. Many osus are still in Alaigbo; they are no longer osu though they are not allowed to interact with Dialas (freeborn).

Africans, Arabs and Europeans were equally guilty in enslaving Africans. All of them ought to make amends for their crime against humanity. It is not the case that only white folk were guilty for this criminal behavior.

If folk are going to pay reparations it must be Africans in Africa, Arabs and whites, all of them making payments to the blacks in the Diaspora, not to African scam artists calling themselves politicians, trying to make white folk feel guilty and give them money, money that they would squander in foolish living and not use it to help their people.

DISCUSSION

I must admit that one of my goals is to get Africans to feel guilty for their heinous crime of selling their people and make amends for it. I am sick and tired of Africans not feeling guilty for their part in selling their people and, instead, pointing accusatory fingers at white folks. One is not excusing white folk's role in buying and abusing Africans; one is just not willing to accuse one party in a criminal transaction and not the other.

If the world allows Africans to continue not feeling guilty and remorse for their criminal behavior in selling their people, Africans would keep on not feeling guilty and remorse for their present antisocial behaviors when they steal from their peoples national treasuries. The world would be reinforcing criminality in Africans hence they remain criminals who steal from their people rather than serve them.

To produce good governance in Africa we must make Africans start feeling guilty, depressed, for their antisocial and criminal behaviors.

CONCLUSION

I tend to be misunderstood. Thus some Africans see me as hating Africans. I do not hate Africans; I am interested in the truth. The truth requires us to accept that Europeans, Arabs and Africans did wrong in selling and buying slaves. All three parties ought to be made to pay a price for their evil, so as to prevent them from engaging in further evil.

I know that Africans self esteems are fragile. They were recently colonized by Europeans and, therefore, feel inferior to whites. Therefore men of goodwill are motivated to protect Africans fragile egos by telling them that they were innocent persons that white folk exploited.

This seeming understanding of Africans and making excuses for them is condescending behavior. It is treating Africans as if they are children. It perpetuates their tendency to be childish.

We must start treating Africans as if they are adults, for they are adults! This entails telling Africans that they were guilty in selling their people.

Guilt feeling makes folk depressed. To avoid depression folk deny guilt and in doing so become paranoid.

As any mental health professional knows, Africans tend to be more paranoid than depressed.

William Meissner pointed out that paranoid persons tend to be less emotionally developed than depressed persons.

If what it takes to make Africans to become adults is to make them depressed, so be it.

What concerns me is stating the truth, as I see it. As I see it, Africans participated in selling their people and, therefore, were as culpable as those who bought them. The seller and buyer of slaves must make amends for their criminal behaviors.

Further reading

William Meissner. The Paranoid Process; Psychotherapy for the Paranoid Process.

David Swanson et al. The Paranoid. David Shapiro.

Autonomy and the Rigid Character; Neurotic Styles.Ozodi Thomas Osuji, Dibia

December 9, 2008

ozodiosuji@gmail.com



William Wilberforce

On Friday July 26th 1833 as he lay on his deathbed Wilberforce exclaimed: "Thank God that I have lived to witness the day in which England is willing to give £20 million for the abolishment of slavery." (What would that be worth today ?)

He died three days later.

The Slavery Abolition Bill 1833 passed through the House of Lords, it received the Royal Assent (which means it became law) on 29 August 1833 and came into force on 1 August 1834. On that date slavery was abolished throughout the vast British Empire.

The Act automatically applied as new possessions (principally in Africa) subsequently became part of the British Empire.

To know who rules over you.

Simply find out who it is that you are not allowed to criticise.

.....Voltaire

We, as White people, have been GAGGED!! Then bullied, insulted, demonised, and provoked, until we object and complain. We then get called *dirty names* like Nazi, Racist, White Extremist, etc, etc.

Our weak & corrupt Lib/Lab/Con Politicians are the problem. As of Jan 2021, the UK elections are years away. Check out Populism, and Nationalism ASAP. Become "WHITE WOKE" & Push Back.

Do it today, NOW!

African Slave Trade: A History

by Angela Thompsell Updated March 06, 2017

From <https://www.thoughtco.com/african-slave-traders-44538>

During the era of the trans-Atlantic slave trade, Europeans did not have the power to invade African states or kidnap African slaves at will. For the most part, the 12.5 million slaves transported across the Atlantic Ocean were purchased from African slave traders. It is a piece of the triangle trade about which there are still many critical misperceptions.

Motivations for Slavery

One question that many Westerners have about African slavers, is why were they willing to sell 'their own people'?

Why would they sell Africans to Europeans? The simple answer to this question is that they did not see slaves as 'their own people.' Blackness (as an identity or marker of difference) was a preoccupation of Europeans, not Africans. There was also in this era no sense of being 'African'. (Indeed, to this day, individuals are more likely to identify as being African rather than, say, Kenyan only after leaving Africa.)

Some slaves were prisoners of war, and many of these may have been seen as enemies or rivals to those who sold them. Others were people who had fallen into debt. They were different by virtue of their status (what we might think of today as their class). Slavers also kidnapped people, but again, there was no reason they would inherently see slaves as 'their own'.

Slavery as a Part of Life

It might be tempting to think that African slave traders did not know how bad European plantation slavery was, but there was a lot of movement across the Atlantic.

Not all traders would have known about the horrors of the Middle Passage or what life awaited slaves, but others at least had an idea.

There are always people willing to ruthlessly exploit others in the quest for money and power, but the story of the African slave trade goes much further than a few bad people.

Slavery and the sale of slaves, though, were parts of life. The concept of not selling slaves to willing buyers would have seemed strange to many people up until the

1800s. The goal was not to protect slaves, but to ensure that oneself and one's kin were not reduced to slaves.

A Self-Replicating Cycle

As the slave trade intensified in the 16 and 1700s, it also became harder not to participate in the trade in some regions of West Africa. The enormous demand for African slaves led to the formation of a few states whose economy and politics were centered around slave raiding and trading. States and political factions that participated in the trade gained access to firearms and luxury goods, which could be used to secure political support. States and communities who were not actively participating in the slave trade were increasingly at a disadvantage. The Mossi Kingdom is an example of a state that resisted the slave trade until the 1800s, when it began trading in slaves as well.

Opposition to the Trans-Atlantic Slave Trade

The Mossi Kingdom was not the only African state or community to resist selling slaves to Europeans. For instance, the king of the Kongo, Afonso I, who had converted to Catholicism, tried to stop the slave of slaves to Portuguese traders.

He lacked the power, however, to police the whole of his territory, and traders as well as nobles engaged in the Trans-Atlantic slave trade to gain wealth and power. Alfonso tried writing to the Portuguese king and asking him to stop Portuguese traders from engaging in the slave trade, but his plea was ignored.

The Benin Empire offers a very different example. Benin sold slaves to Europeans when it was expanding and fighting many wars - which produced prisoners of war. Once the state stabilized, it stopped trading slaves, until it started to decline in the 1700s. During this period of increasing instability, the state resumed participation in the slave trade.

Marxist Generals - Ethnic Soldiers - White Victims - Worldwide



Home  Index



William Wilberforce

On Friday July 26th 1833 as he lay on his deathbed Wilberforce exclaimed: "Thank God that I have lived to witness the day in which England is willing to give £20 million for the abolishment of slavery." (What would that be worth today?)

He died three days later.

The Slavery Abolition Bill 1833 passed through the House of Lords, it received the Royal Assent (which means it became law) on 29 August 1833 and came into force on 1 August 1834. On that date slavery was abolished throughout the vast British Empire.

The Act automatically applied as new possessions (principally in Africa) subsequently became part of the British Empire.

To know who rules over you. Simply find out who it is that you are not allowed to criticise.Voltaire

We, as White people, have been GAGGED!! Then bullied, insulted, demonised, and provoked, until we object and complain. We then get called *dirty names* like Nazi, Racist, White Extremist, etc, etc.

Our weak & corrupt Lib/Lab/Con Politicians are the problem. As of Jan 2021, the UK elections are years away. Check out Populism, and Nationalism ASAP. Become "WHITE WOKE" & Push Back.

Do it today, NOW!

Black African Slave Traders

Historically, West Africa is associated with the slave, gold and ivory trades, perhaps most often the former.

From http://www.pbs.org/wonders/Episodes/Epi3/slave_2.htm

Historically, West Africa is associated with the slave, gold and ivory trades, perhaps most often the former. West Africa is also the place of origin of vodou, the only indigenous African religion to survive the trans-Atlantic slave trade and remain in practice in the Americas today. The historical roots of racial discrimination in the United States today can be traced back to North American slavery and the kidnapping of more than 20 million Africans. It is easily assumed, therefore, that the African slave trade pit brutal, gun-wielding European slaver traders against unsuspecting, passive African victims. While the Dutch, Spanish, Portuguese, English and French slave traders were often brutal, they were not always working alone -- many Africans were also complicit in this victimization. Precolonial empires such as Dahomey and Ashanti (located in what is now Benin and Ghana), where slave ports at Ouidah and Elmina flourished, accumulated enormous wealth and power as a result of the trade of their fellow Africans.

In fact, Europeans often acted as junior partners to African rulers, merchants, and middlemen in the slave trade along the West African coast from the mid-15th century on. Two factors contributed to this dependency: the coastal geography and the diseases of West Africa. Seasonal wind patterns along the Atlantic coast of Africa generated heavy surf and dangerous crosscurrents, which in turn buffeted a land almost entirely lacking in natural harbors. Hazardous offshore reefs and sandbars complicated the matter even further for seafarers along the West African coast. European commerce in West Africa took place, therefore, most often on ships anchored well away from shore and dependent on skilled African canoe-men whose ability to negotiate across the hazardous stretch of water between the mainland and the waiting ships made the Atlantic trade possible.

Even in places where Europeans were able to conduct trade on the mainland, their presence was limited by an epidemiological situation that impeded their livelihood and threatened their lives. Malaria, dysentery, yellow fever, and other diseases reduced the few Europeans living and trading along the West African coast to a chronic state of ill health and earned Africa the name "white man's grave." In this environment, European merchants were rarely in a position to call the shots.

Furthermore, when Europeans first initiated a trading relationship with West Africans in the mid-15th century they encountered well-established and highly-developed political organizations and competitive regional commercial networks. Europeans relied heavily on the African rulers and mercantile classes at whose

mercy, more often than not, they gained access to the commodities they desired. European military technology was not effective enough to allow them this access by means of force on a consistent basis until the 19th century. Therefore it was most often Africans, especially those elite coastal rulers and merchants who controlled the means of coastal and river navigation, under whose authority and to whose advantage the Atlantic trade was conducted.

Domestic slave ownership as well as domestic and international slave trades in western Africa preceded the late 15th-century origins of the Atlantic slave trade. Since most West African societies did not recognize private property in land, slaves functioned as one of the only profitable means of production individuals could own. West Africans, therefore, acquired and expressed wealth in terms of dependent people, whether as kin, clients, or slaves. Moreover, caravan routes had long linked sub-Saharan African peoples with North Africa and the wider Mediterranean and Middle Eastern worlds. Not only was slavery an established institution in West Africa before European traders arrived, but Africans were also involved in a trans-Saharan trade in slaves along these routes. African rulers and merchants were thus able to tap into preexisting methods and networks of enslavement to supply European demand for slaves. Enslavement was most often a byproduct of local warfare, kidnapping, or the manipulation of religious and judicial institutions. Military, political, and religious authority within West Africa determined who controlled access to the Atlantic slave trade. And some African elites, such as those in the Dahomey and Ashanti empires, took advantage of this control and used it to their profit by enslaving and selling other Africans to European traders.

It is important to distinguish between European slavery and African slavery. In most cases, slavery systems in Africa were more like indentured servitude in that the slaves retained some rights and children born to slaves were generally born free. The slaves could be released from servitude and join a family clan. In contrast, European slaves were chattel, or property, who were stripped of their rights. The cycle of slavery was perpetual; children of slaves would, by default, also be slaves. Although the historical reality is sometimes difficult to accept by African Americans who still face racial discrimination over a century after the abolition of slavery, African complicity in the slave trade neither justifies today's social problems nor minimizes their seriousness. Fifteenth-century Africa, was not a homogenous group of people. Some African elites benefited from the enslavement of their rivals, their enemies, their poor, and other * culturally foreign groups from the 15th century through the 18th and even into the 19th centuries. Class, language, religion, gender, and ETHNICITY divided Africans, and it was along these lines that certain Africans participated in the slave trade. Understanding the dynamics of African complicity in the slave trade is important in understanding Africans as historically active and diverse human beings. This understanding should not detract from the horrors of the slave trade or from its American legacy of inequality and racism.

By Zayde Antrim



William Wilberforce

On Friday July 26th 1833 as he lay on his deathbed Wilberforce exclaimed: "Thank God that I have lived to witness the day in which England is willing to give £20 million for the abolishment of slavery." (What would that be worth today ?)

He died three days later.

The Slavery Abolition Bill 1833 passed through the House of Lords, it received the Royal Assent (which means it became law) on 29 August 1833 and came into force on 1 August 1834. On that date slavery was abolished throughout the vast British Empire.

The Act automatically applied as new possessions (principally in Africa) subsequently became part of the British Empire.

To know who rules over you. Simply find out who it is that you are not allowed to criticise.Voltaire

We, as White people, have been GAGGED!! Then bullied, insulted, demonised, and provoked, until we object and complain. We then get called *dirty names* like Nazi, Racist, White Extremist, etc, etc.

Our weak & corrupt Lib/Lab/Con Politicians are the problem. As of Jan 2021, the UK elections are years away. Check out Populism, and Nationalism ASAP. Become "WHITE WOKE" & Push Back.

Do it today, NOW!

Islamic Slavery And Racism

The Tuaregs were not former slaves, they were, and in some cases still are, slaveholders.

From <http://frontpagemag.com>

When Tuaregs and Islamists swarmed in to seize Northern Mali, one of the old grievances animating their campaign was slavery. The Tuaregs were not former slaves, they were, and in some cases still are, slaveholders.

The French invasion of Northern Mali, liberating towns and villages under Islamist rule, was a historical echo of the original French emancipation of Tuareg slaves back in the colonial period. Despite French efforts, the Tuareg did their best to hang on to their slaves and Muslim Tuareg still continue to hold thousands of slaves in Northern Mali.

Mali is not unique. The Sudanese genocide was given theological and political force by the attitude that Arabs and Muslims had the natural right to a superior position over African Animists and Christians. And today Omar Hassan al-Bashir, the Butcher of Sudan, continues to enjoy the support of the Muslim world despite being indicted for genocide by the International Criminal Court.

The supporters of the Muslim world's campaign to displace the indigenous Jewish population of Israel in favor of the Arab colonists and settlers casually accuse Israel of apartheid. Every year Israeli Apartheid Week is held on college campuses in an attempt to compare Israel's refusal to allow Hamas terrorists access to its territory with racial discrimination.

But racial Apartheid is very much a reality in the Muslim world. The same Muslim students who show up to denounce Israel as an apartheid state often come from countries where there is true apartheid when it comes to black skin.

In North Africa, the Haratin, a Berber word meaning dark skin, are the remnants of the indigenous African population. Many are still enslaved. Others live apart from mainstream society, forced into degrading or difficult occupations.

Mauritania is the country with the world's largest proportion of slaves. There hundreds of thousands of Haratin serve the Bidhan, the so-called "White Moors". The Bidhan pass on the Haratin as property from generation to generation. And even those who are not legally property face a grim life.

In the 80s, Mauritania ethnically cleansed tens of thousands of Africans from its territory. Even Human Rights Watch stated, "It is fair to say that the Mauritanian government practices undeclared apartheid and severely discriminates on the basis of race."

The best kept secrets of the Muslim world include large populations of former African slaves in places like Pakistan, Iraq and Turkey. While Africans in Israel are not descended from slaves, Afro-Arabs, Afro-Turks and African-Pakistanis are living reminders of a Muslim slave trade that sometimes still lingers on.

The site of the world's greatest slave rebellion was in Basra, Iraq, where half-a-million African slaves rose against the might of the Arab Abbasid Empire.

The Zanj rebellion was brutally suppressed, but its legacy lives on in the modern day city of Basra where hundreds of thousands of Afro-Iraqis live as a despised minority taunted with the slur "Abd" or Slave. That same Arabic word is often widely applied to black people in the Middle East.

While Muslim propagandists have exploited the legacy of slavery in the United States to win black converts, slavery in the Muslim world began long before the United States and ended a century later.

President Abraham Lincoln issued the Emancipation Proclamation in 1862. By contrast, Saudi Arabia only abolished slavery in 1962. That same year Yemen abolished slavery and the United Arab Emirates abolished slavery a year later.

Saudi Arabia's ruling family did not embark on this course out of the goodness of their hearts, but under pressure from President Kennedy, at a time when the House of Saud did not yet have the United States economy and its foreign policy in a headlock. The abolition of slavery was a compromise. Kennedy had wanted representative government and civil rights. He had to settle for a belated emancipation.

Slavery has been officially abolished; unofficially it lingers on. There is still a silent unofficial slave trade that is carried on and leading Saudi clerics have insisted that slavery is a part of Islam. Saudis living abroad are often discovered to have domestic workers who live like slaves leading to criminal cases.

The situation is worst in North Africa where Arab colonization largely displaced and suppressed the indigenous peoples, like the Nubians in Egypt. Ethnically cleansed to make way for the Lake Nasser project, Egyptian Nubians have, like so many other North African indigenous peoples, been reduced to a persecuted minority within their own land.



William Wilberforce

On Friday July 26th 1833 as he lay on his deathbed Wilberforce exclaimed: "Thank God that I have lived to witness the day in which England is willing to give £20 million for the abolishment of slavery." (What would that be worth today ?) He died three days later.

The Slavery Abolition Bill 1833 passed through the House of Lords, it received the Royal Assent (which means it became law) on 29 August 1833 and came into force on 1 August 1834. On that date slavery was abolished throughout the vast British Empire. The Act automatically applied as new possessions (principally in Africa) subsequently became part of the British Empire.

To know who rules over you. Simply find out who it is that you are not allowed to criticise.Voltaire

We, as White people, have been GAGGED!! Then bullied, insulted, demonised, and provoked, until we object and complain. We then get called *dirty names* like Nazi, Racist, White Extremist, etc, etc.

Our weak & corrupt Lib/Lab/Con Politicians are the problem. As of Jan 2021, the UK elections are years away. Check out Populism, and Nationalism ASAP. Become "WHITE WOKE" & Push Back.

Do it today, NOW!

Some may argue that Islamic slavery, like Islamic terrorism, has nothing to do with Islam, and yet the rationale for racial slavery can be found in the Koran and the Hadiths which discuss Mohammed's trade in black slaves.

Al-Tabari wrote that, "Noah prayed that the hair of Ham's descendants would not grow beyond their ears, and that whenever his descendants met Shem's, the latter would enslave them." This theological justification provided a religious manifest destiny for the Arab conquests and acts of ethnic cleansing in Africa.

The great Muslim historian Ibn Khaldun justified slavery by relegating black people to the rank of animals, writing, "The only people who accept slavery are the Negroes, owing to their low degree of humanity and proximity to the animal stage."

The legacy of Islam makes the permanent abolition of slavery and racism impossible. Egypt and its Mamaluk slave empire fell in the 19th century and British attempts to abolish slavery appeared to have done the job, but the new Muslim Brotherhood constitution dropped the old ban on slavery. Mauritania officially outlawed slavery numerous times, but it still widely persists. Saudi Arabia abolished slavery, but its elite families, of whom the Hadiths say, Allah chose the Arabs above all others and chose the Quraysh above the Arabs, still fall back into their old habits even in the West.

The oil-rich tyrannies at the heart of the Islamic Gulf are maintained by armies of slave laborers with few rights. The skyscrapers of Dubai and Doha are built with the blood of thousands of foreign workers who are paid a pittance and are only allowed to leave with the approval of their masters.

Ali al-Ahmed, a leading Saudi scholar and the director of the Institute for Gulf Affairs, put it bluntly in Foreign Policy magazine. "Blacks, who make up around 10 percent of the population, are banned from judgeships — as are women and Muslims who observe a different version of the faith — because the monarchy's religious tradition still views blacks as slaves, other Muslims as heretics, and women as half human. There is only one word to describe such a system: Apartheid."

While Saudi money goes to sponsor propaganda that accuses Israel of Apartheid for fighting Saudi-backed terrorist groups, the brutal kingdom continues an ancient policy of slavery and repression.

And in North Africa, African migrants look to the West to escape racism in lands colonized by Islam. "Arabs hate black people. And that is not from today, it is in their blood," a young African man named Aboubakr says. "Blacks have no rights here."



William Wilberforce

On Friday July 26th 1833 as he lay on his deathbed Wilberforce exclaimed: "Thank God that I have lived to witness the day in which England is willing to give £20 million for the abolishment of slavery." (What would that be worth today ?) He died three days later.

The Slavery Abolition Bill 1833 passed through the House of Lords, it received the Royal Assent (which means it became law) on 29 August 1833 and came into force on 1 August 1834. On that date slavery was abolished throughout the vast British Empire. The Act automatically applied as new possessions (principally in Africa) subsequently became part of the British Empire.

To know who rules over you. Simply find out who it is that you are not allowed to criticise.Voltaire

We, as White people, have been GAGGED!! Then bullied, insulted, demonised, and provoked, until we object and complain. We then get called *dirty names* like Nazi, Racist, White Extremist, etc, etc.

Our weak & corrupt Lib/Lab/Con Politicians are the problem. As of Jan 2021, the UK elections are years away. Check out Populism, and Nationalism ASAP. Become "WHITE WOKE" & Push Back.

Do it today, NOW!

Slavery In The Arab World



William Wilberforce
On Friday July 26th 1833 as he lay on his deathbed Wilberforce exclaimed: "Thank God that I have lived to witness the day in which England is willing to give £20 million for the abolishment of slavery." (What would that be worth today ?)
He died three days later.

The Slavery Abolition Bill 1833 passed through the House of Lords, it received the Royal Assent (which means it became law) on 29 August 1833 and came into force on 1 August 1834. On that date slavery was abolished throughout the vast British Empire. The Act automatically applied as new possessions (principally in Africa) subsequently became part of the British Empire.

To know who rules over you. Simply find out who it is that you are not allowed to criticise.Voltaire

We, as White people, have been GAGGED!! Then bullied, insulted, demonised, and provoked, until we object and complain. We then get called *dirty names* like Nazi, Racist, White Extremist, etc, etc.

Our weak & corrupt Lib/Lab/Con Politicians are the problem. As of Jan 2021, the UK elections are years away. Check out Populism, and Nationalism ASAP. Become "WHITE WOKE" & Push Back.
Do it today, NOW!

high casualty rate. Gordon notes that the typical practice was to conduct a pre-dawn raid on an unsuspecting village and kill off as many of the men and older women as possible. Young women and children were then abducted as the preferred "booty" for the raiders.

Young women were targeted because of their value as concubines or sex slaves in markets. "The most common and enduring purpose for acquiring slaves in the Arab world was to exploit them for sexual purposes," writes Gordon. "These women were nothing less than sexual objects who, with some limitations, were expected to make themselves available to their owners. . .Islamic law, as already noted, catered to the sexual interests of a man by allowing him to take as many as four wives at one time and to have as many concubines as his purse allowed." Young women and girls were often "inspected" before purchase in private areas of the slave market by the prospective buyer.

Racism Toward Black Africans

Some of Gordon's research disputes the oft-repeated charge that racism did not play a part in Islamic slave society. While it is true that the Muslims of the Middle East took slaves of all colors and ethnicities, they considered white slaves more valuable than black ones and developed racist attitudes toward the darker skinned people. Even the famous Arab philosopher Ibn Khaldun, expressed racist attitudes toward black Africans: "The only people who accept slavery are the Negroes, owing to their low degree of humanity and their proximity to the animal stage," Khaldun wrote. Another Arab writer, of the 14th Century, asked: "Is there anything more vile than black slaves, of less good and more evil than they?"

Gordon covers the Arab/African slave trades up until the mid-20th Century, noting that Saudi Arabia only abolished the practice in the early 1960s. Unlike the European nations and the USA, the Arab nations did not abolish African slavery voluntarily out of moral conscience, but due to considerable economic and military pressure applied by the great colonial powers of time, France and Britain.

Slavery is still practiced in two Islamic nations: The Sudan and Mauritania.



Slavery in the Arab World
Murray Gordon
New Amsterdam Books, New York, NY 1989

From <http://www.faithfreedom.org>

In his fact-filled work on the history of the Muslim Arab slave trade in Africa, Murray Gordon notes that this trade pre-dated the European Christian African slave trade by a thousand years and continued for more than a century after the Europeans had abolished the practice. Gordon estimates the number of slaves "harvested" from Black Africa over the period of the Muslim Arab slave trade at 11 million – roughly equal to the number taken by European Christians for their colonies in the New World.

"Despite the long history of slavery in the Arab World and in other Muslim lands, little has been written about this tragedy," writes Gordon in his introduction. "Except for the few abolitionists, mainly in England, who railed against Arab slavery and put pressure upon Western governments to end the traffic in slaves, the issue has all but been ignored in the West."

'Conspiracy of Silence' on Arab Slave Trade

Gordon decries a "conspiracy of silence. . .[that] has blocked out all light on this sensitive subject." Among scholars in the Arab world, the author points out, "No moral opprobrium has clung to slavery since it was sanctioned by the Koran and enjoyed an undisputed place in Arab society."

The book starts out with a brief outline of the growth of the Islamic attitude toward slavery. There is no evidence that Muhammad sought to abolish slavery, notes Gordon, although he urged slave-owners to treat their slaves well and grant them freedom as a meritorious deed.

"Some Muslim scholars have taken this to mean that his true motive was to bring about a gradual elimination of slavery. Far more persuasive is the argument that by lending the moral authority of Islam to slavery, Muhammad assured its legitimacy. Thus, in lightening the fetter, he riveted it ever more firmly in place."

High Rate of Black African Casualties

While Gordon acknowledges that at times the Islamic version of slavery could be more "humane" than the European colonial version, he provides many facts which point out that the Muslim variety of slavery could be extremely cruel as well.

One particularly brutal practice was the mutilation of young African boys, sometimes no more than 9 or ten years old, to create eunuchs, who brought a higher price in the slave markets of the Middle East. Slave traders often created "eunuch stations" along the major African slave routes where the necessary surgery was performed in unsanitary conditions. Gordon estimates that only one out of every 10 boys subjected to the mutilation actually survived the surgery. The taking of slaves – in razzias, or raids, on peaceful African villages – also had a

Black Slaveowners And Slavemasters

Larry Koger writes, "By and large, Negro slaveowners were darker copies of their white counterparts."

From <http://www.issues-views.com/index.php/sect/1006/article/1091>

During this country's period of slavery, many freed blacks worked for years to purchase the freedom of family members. But a great many freemen became slave masters themselves, and for the same reason as whites--to make use of slave labor for the sake of profits. Larry Koger writes, "By and large, Negro slaveowners were darker copies of their white counterparts." Following are excerpts from Chapter 6 of his book, *Black Slaveowners: Free Black Slave Masters in South Carolina, 1790-1860* [University of South Carolina Press].

Many historians have argued that the majority of black masters purchased their relatives and friends who were held in bondage. Being unable to manumit their loved ones, the black masters were forced to hold their kinsfolk and friends as nominal slaves. So they treated their relatives and friends as free persons, and whenever possible, they attempted to manumit their loved ones. Thus the dominant pattern of slaveholding that developed among free blacks was benevolent and based primarily on kinship. The chief architect of the benevolent interpretation was Carter G. Woodson, and his thesis has been accepted by most historians.

Yet the Woodson thesis has many weaknesses that have been overlooked or not fully explored by its supporters. Furthermore, the Woodson thesis has been overemphasized, while the other side of free black slaveowning has been characterized as a minor facet by many scholars. However, there is ample evidence which demonstrates that free blacks purchased slaves as capital investments. To many black masters, slaves represented valued property being used to produce more wealth. These slaveowners, therefore, bought slaves as commercial assets and used them to make a profit. In fact, the commercial side of free black slaveholding was more prevalent than previously maintained by historians. In short, the Woodson thesis that most free black slaveowners were benevolent masters may be a myth. . . .

Even though [black] slaveowners usually demonstrated benevolent behavior towards their slave relations and friends, a commercial or materialistic exchange existed between them and their slaves purchased as investments. In fact, the free blacks who maintained a dual relationship with their slaves had no universal commitment against slavery. To them, slavery was an oppressive institution when it affected a beloved relative or a trusted friend, but beyond that realm, slavery was viewed as a profit-making institution to be exploited.

In many instances, free black slaveowners shared a similar view of slavery with their white counterparts. Slaveowners of both races occasionally manumitted a trusted servant and in the same moment requested the sale of another slave. The act of freeing one or several slaves while others remained in bondage did not constitute a firm commitment against slavery, but a personal view which acknowledged that some slaves, through merit or hard work, deserved their freedom, while others were destined to be slaves until death. So when philanthropic free blacks purchased slaves and then emancipated them, they were not always paternalistic owners as Carter G. Woodson suggested.

For example, Richard Holloway, Sr., a free black of Charleston City, bought a slave named Charles Benford in order that the slave might enjoy his freedom. Yet at the same time, he owned other slaves who were not treated so kindly. In 1834, for instance, he purchased a Negro woman named Sarah and her two children, Annett and Edward, from Susan B. Robertson for \$575. Within three years after the purchase, he apparently became dissatisfied with the slave family and sold them for \$945. Even though Richard Holloway, Sr., allowed a trusted servant to enjoy a greater degree of freedom, he was still a slaveowner for profit. So he sold and purchased slaves as an investment even while he held other slaves for benevolent reasons. To consider him a benevolent master would be erroneous because he also exploited other slaves for his own benefit.

Another example of the dual interaction between black masters and their slaves is the case of Rose Summers. In her will, she stated: "I desire as soon as it may be practicable that my Executor herein named will sell for money my four slaves to the best possible advantage together with all my household Furniture" While Summers requested that the children of her trusted servant Bellah should be emancipated, her other slaves were doomed to the auction block. In December 1840, her executor sold the slave woman Elsey; then the slaves Sam and Henry were auctioned to the highest bidder for \$970.13 in January 1841. Shortly after that date, the slave woman named Harriet was sold by the executor of Rose Summers for \$300. After the sale of the Negro slaves and the furniture, the estate of Rose Summers netted \$1,334.79, which was divided among five colored women designated as heirs by the deceased woman. . . .

When Carter G. Woodson declared that "the majority of Negro owners of slaves were such from the point of view of philanthropy," he failed to consider that there were so-called benevolent masters who freed one slave and sold another slave for profit. Woodson's perceptions of free black slaveholding were partially correct; however, when the totality of the institution is examined, his assumptions are revealed to be erroneous. . . .

Many black masters were firmly committed to chattel slavery and saw no reasons for manumitting their slaves. To those colored masters, slaves were merely property to be purchased, sold or exchanged. Their economic self-interest overrode whatever moral concerns or guilt they may have harbored about slavery.



William Wilberforce

On Friday July 26th 1833 as he lay on his deathbed Wilberforce exclaimed: "Thank God that I have lived to witness the day in which England is willing to give £20 million for the abolishment of slavery." (What would that be worth today ?)

He died three days later.

The Slavery Abolition Bill 1833 passed through the House of Lords, it received the Royal Assent (which means it became law) on 29 August 1833 and came into force on 1 August 1834. On that date slavery was abolished throughout the vast British Empire.

The Act automatically applied as new possessions (principally in Africa) subsequently became part of the British Empire.

To know who rules over you. Simply find out who it is that you are not allowed to criticise.Voltaire

We, as White people, have been GAGGED!! Then bullied, insulted, demonised, and provoked, until we object and complain. We then get called *dirty names* like Nazi, Racist, White Extremist, etc, etc.

Our weak & corrupt Lib/Lab/Con Politicians are the problem. As of Jan 2021, the UK elections are years away. Check out Populism, and Nationalism ASAP. Become "WHITE WOKE" & Push Back.

Do it today, NOW!



William Wilberforce

On Friday July 26th 1833 as he lay on his deathbed Wilberforce exclaimed: "Thank God that I have lived to witness the day in which England is willing to give £20 million for the abolishment of slavery." (What would that be worth today ?) He died three days later.

The Slavery Abolition Bill 1833 passed through the House of Lords, it received the Royal Assent (which means it became law) on 29 August 1833 and came into force on 1 August 1834. On that date slavery was abolished throughout the vast British Empire. The Act automatically applied as new possessions (principally in Africa) subsequently became part of the British Empire.

To know who rules over you. Simply find out who it is that you are not allowed to criticise.Voltaire

We, as White people, have been GAGGED!! Then bullied, insulted, demonised, and provoked, until we object and complain. We then get called *dirty names* like Nazi, Racist, White Extremist, etc, etc.

Our weak & corrupt Lib/Lab/Con Politicians are the problem. As of Jan 2021, the UK elections are years away. Check out Populism, and Nationalism ASAP. Become "WHITE WOKE" & Push Back.

Do it today, NOW!

James, and George. . . . By and large, slaves conveyed in marriage contracts were seen as property by their colored owners.

The probate records also demonstrated the commercial motives of black slaveholding in South Carolina. In scores of wills, black slave masters used their human chattel as commercial assets, requesting that their slaves should be auctioned to the highest bidder for payment of their debts or for the benefit of family members. In 1820, Benjamin Lincoln, a free black and a tailor of Charleston City, instructed his executors to "sell my Negro Woman Slave Phillis and for the proceeds thereof to pay my just debts. . . ."

Abraham Jackson, an ex-slave from St. Paul's Parish, stipulated that "my Negro Woman by the name Sarah be immediately set free from all Servitude . . ." However, Jackson did not emancipate the children of the slave woman, but requested that they be disposed of as "my Executor shall judge proper . . ." Indeed, even as the colored masters were making their deathbed testaments, the commercial bond of slavery permeated their dying demands. To them, slavery remained an economic system to be exploited. . . .

Clearly, the bond of kinship compelled the colored slaveholders to inform their executors that their loved ones were not chattel to be humiliated and dehumanized by appraising them at the level of horses, cattle, and swine, narrowed to the impersonal medium of gold and silver. Yet the colored masters who were not related to their servants were not restrained from considering their slaves as chattel. Consequently, when the executors of the commercial masters filed their inventories, those slaves were appraised just like cattle and pigs. . . .

The commercial impulse of black slaveholding can be examined nowhere better than in Charleston City. In the port city, the environment was conducive to black slaveholding. The urban setting of Charleston provided many free blacks with the economic opportunity to prosper. . . . In fact, free blacks nearly monopolized such work as barbering, bricklaying, shoemaking, and tailoring. Once the black entrepreneurs were able to establish themselves and had developed a clientele, they began to prosper and eventually earned the capital needed to invest in slaves. So it was quite common for free black artisans to purchase slaves and use them in their businesses.

In 1822, Moses Brown, a colored barber, purchased a Negro boy named Moses from Mary Warhaim for \$300. Since Moses Brown was a barber, he instructed his slave in the art of cutting hair. By 1823 the slave boy was working in his master's shop on 5 Tradd Street. Also in 1829, Camilla Johnson, a colored pastry cook, purchased a mulatto woman named Diana Todd (who was 18 years old) from Joseph and Ann Wilkie for \$375. According to a Charleston socialite, Camilla Johnson used her mulatto servant to work at several of the parties she was hired to cater. As these black artisans began to prosper, they were able to utilize the

Since the black masters benefited from slavery, they rationalized that because the institution was profitable, they could not relinquish their valuable property without being reimbursed. So black masters continued to own slaves even when the Union army was preparing to invade South Carolina in 1864. . . .

The commercial impulse of black masters to exploit the commodity of slave property was recorded not only by the Secretary of State but the Master of Equity in Charleston District. In scores of reports, the black masters appeared to have used their slaves as commodities. . . .

George Shrewsbury and James Hanscome, both colored slave masters, argued over the ownership of three slaves in the court of equity. Rather than sue each other, they filed a complaint against the master of the workhouse because he refused to release the slaves to either of the men until the ownership of the slaves was established. In 1845, the two colored slaveowners filed a suit against the master of the workhouse and claimed that he refused to release their property. . . . The commercial impulses of both colored men are vividly illustrated by the court proceedings. Such cases are not isolated incidents; in fact, they are prevalent in the court records. . . .

For example, there were mortgages registered by free blacks who used their slaves as collateral to secure loans. In 1811, Philis Wells, a free colored woman of Charleston City, used her servant Mark as collateral to obtain a loan from Peter Desportes for \$900. In 1823, a slave named Sarah was used as security by William Aiken, a free black and a carpenter of Charleston City, when he applied for a loan from Joseph S. Brown for \$600. . . .

The black masters who were not related to their slaves by ties of kinship were not personally disturbed when default and seizure occurred. In December 1841, John S. Mark, a barber of Charleston City, bought a Negro man named Billy and his wife, Provy, from Otto Cook for \$420. Two years later, he obtained a loan from George Shrewsbury for \$300. To secure the loan, he mortgaged Billy and Provy. Shortly thereafter, John St. Mark apparently defaulted on the loan and sold the slaves Billy and Provy for \$375. . . .

Most of the black women who conveyed their slaves in marriage settlements were not related to their slaves by kinship; thus their slaves were primarily viewed as commodity. For example, shortly after the marriage settlement of Hannah Norman Miles, she sold her servant woman Lucy, who was part of the chattel in her marriage contract, for 35 pounds sterling. When the bond of kinship has been eliminated from the slaveholding of free blacks, the commercial element becomes a strong motive. Consequently, the colored women who established marriage settlements viewed their slaves as investments to be utilized. In the marriage contract of Claudia Angelina Inglis, the daughter of a colored slaveowning barber from Charleston City, she held one-fifth interest in three slaves named Lindy,

services of slaves, and so they invested in human chattel and trained their servants in the skills of their trade to increase the profits of their businesses. . . .

When black masters exploited their slaves for commercial purposes, they encountered the same problems which perplexed many white slaveowners. Regardless of the color of the slave masters, the oppressive nature of slavery was met with opposition from the slaves.

Many black masters were faced with the dilemma of controlling their slaves when they exploited the labor of their servants. The black masters believed that punishment was a necessary instrument to control their slaves and preserve a sense of authority. Like white slaveowners, the black masters placed disobedient slaves in the city jail or the workhouse and contemplated further punishment for their servants. In 1851, Elizabeth Collins Holloway, a colored woman, placed her servant Celia in the city jail after her slave had run away. In 1852, Holloway's servant Peggy was confined in the workhouse for disciplinary reasons. Such a confinement usually lasted from five to thirty days, depending upon the disposition of the slave masters. After the slaves were released from the workhouse, it was not unusual for their masters to give them a flogging for their disobedience. . . .

By and large, the commercial impulse of black masters to exploit their slaves was quite apparent in Charleston City. Many slaveowners of African descent used the labor of slaves for their own benefit. Yet the exploitation of slave labor was not always a smooth process because the slaves of black masters attempted to assert their own rights to freedom by resisting their owners.

Thus, Carter G. Woodson's serene picture of black slaveholders does not totally portrait the realities of the institution.



William Wilberforce

On Friday July 26th 1833 as he lay on his deathbed Wilberforce exclaimed: "Thank God that I have lived to witness the day in which England is willing to give £20 million for the abolishment of slavery." (What would that be worth today ?)

He died three days later.

The Slavery Abolition Bill 1833 passed through the House of Lords, it received the Royal Assent (which means it became law) on 29 August 1833 and came into force on 1 August 1834. On that date slavery was abolished throughout the vast British Empire.

The Act automatically applied as new possessions (principally in Africa) subsequently became part of the British Empire.

To know who rules over you. Simply find out who it is that you are not allowed to criticise.Voltaire

We, as White people, have been GAGGED!! Then bullied, insulted, demonised, and provoked, until we object and complain. We then get called *dirty names* like Nazi, Racist, White Extremist, etc, etc.

Our weak & corrupt Lib/Lab/Con Politicians are the problem. As of Jan 2021, the UK elections are years away. Check out Populism, and Nationalism ASAP. Become "WHITE WOKE" & Push Back.

Do it today, NOW!

Did African Slave Traders Sell Us Out

(Tingba Muhammad is a citizen of the Nation of Islam and a member of the Nation of Islam Research Group.)

From http://www.finalcall.com/artman/publish/Perspectives_1/article_8941.shtml

One of the most unseemly manifestations of Black self-hatred is the often violently held belief that 500 years ago Africans sold other Africans into centuries of slavery. It is heard most often when a Negro feels the need to shield Whites and Jews from having to answer for their dominant role in the Black Holocaust. "It was Blacks who sold other Blacks," says the Negro, "so we can not hold Whites responsible for a crime in which we participated." And by that suspect reasoning, they dismiss out of hand 500 years of the most brutal and murderous history the planet has ever known.

It is almost impossible to imagine a Jewish person saying anything similar: "Since there were Jews that financially supported Hitler, and Jews that were soldiers and officers in the Nazi army, and Jews that delivered other Jews to the concentration camps, I don't want to hear about any Jewish Holocaust. We Jews helped Hitler!"

The fact is, there actually were Jewish Nazis, and at least 77 Jews were officers in Hitler's army, and a Jewish police force called the Judenrat was in charge of rounding up Jews for the death camps (they even had uniforms and star-of-David badges), but no Jew allows those facts to minimize the German responsibility for their people's suffering. People who had no possible connection to the Jewish Holocaust—like the PALESTINIANS—must pay the price even before those Nazi-collaborating Jews.

Only Blacks seem to have adopted a strange psychosis that exculpates the White perpetrator and blames the Black victim. But this internecine scapegoating wholly depends not just on a colossal ignorance of the historical facts but on the sleight-of-hand deceptions of White historians who seek racial advantage, not historical clarity.

One must look very carefully at the charge of "Black" participation in the African slave trade, and as always the very best place to start is with The Most Honorable Elijah Muhammad. He described the method used by the European in his genocidal pursuit of free Black labor: "He goes into foreign lands of our people and the first thing he goes looking around for, with his green-blue eyes, just to get up to, is the woman, so that he can leave the seed of the devil there." The first 15th-century Portuguese excursions into Africa prove The Messenger to be absolutely correct.

The Portuguese "explorers" used forced breeding on the Africans, a tactic which targets the genetic foundation of the indigenous population. European invaders deliberately created mixed-race subgroups with the intention of using them to capture and enslave the native populations. This "new breed" would serve as a "ruling class" to control the massive numbers of African slave laborers required by the colonies, and further serve as a buffer zone between the White oppressor and his Black victims. In America, we have come to know them as "house niggers," or "mammies," or "uncle toms," and they were most often the lighter-skinned slaves—the children born of the rape of the Black woman. Back in Africa, the horrific suffering and debasement of the Black woman had a very specific economic purpose.

Arriving on the Cape Verde islands, about 350 miles off the coast of Senegal, Jewish slave merchants from Portugal in the mid-1400s sought to insert themselves in Africa's commerce and trade. Just as The Messenger described, they kidnapped and raped African women, and the mixed-race offspring, called lancados, were raised on the island as European Jews, practicing Judaism and respecting Jewish authority. These lancados then were sent into the African mainland to set up an international "trading post" in the fine fabrics being produced by the Africans. But soon they turned on their hosts and began trading in Black human beings. The lancados literally were trained by their Jewish fathers to be slave traders—trained in the Jewish family business of slave-dealing. It was these half-breed, mixed-race (or mulatto) "half-ricans" who infiltrated the Black African communities, seeking to satisfy the European lust for Black labor. Because of their African blood admixture, deceptive White propagandists call these mixed-race Jewish slave traders "Africans"; Blacks view them, rightly, as Europeans, given their racial and cultural distance from African society and its practiced norms of thousands of years. One scholar was clear: "The offspring of these lancados and African women were called Jilhos de terra and were generally considered to be Portuguese."

Historian Walter Rodney described these "AFRICAN" slave traders thus: "Many of the private traders were mulattoes, already linked to the Africans by blood, and there were those who had become so integrated into African life that they wore tribal tattoos. It was these who were the authentic lancados, literally 'those who had thrown themselves' among the Africans."

Even Christopher Columbus was involved in the early slave trade and learned his skills as a sailor on the African coast. The Messenger referred to him as a "half-original man," meaning he had African and European blood. Jewish scholars such as Simon Wiesenthal, Cecil Roth, and Tina Levitan are adamant about Columbus' Jewishness. One might easily conclude that the notorious explorer was one of these lancados.

It is probably during his slave-dealing on coastal Africa that he heard of a "New World" overseas from African mariners, who had been visiting the Americas for thousands of years (see Dr. Ivan Van Sertima's They Came Before Columbus). And if Columbus were not such an important part of the American (White) self-image—



William Wilberforce

On Friday July 26th 1833 as he lay on his deathbed Wilberforce exclaimed: "Thank God that I have lived to witness the day in which England is willing to give £20 million for the abolishment of slavery." (What would that be worth today?)

He died three days later.

The Slavery Abolition Bill 1833 passed through the House of Lords, it received the Royal Assent (which means it became law) on 29 August 1833 and came into force on 1 August 1834. On that date slavery was abolished throughout the vast British Empire.

The Act automatically applied as new possessions (principally in Africa) subsequently became part of the British Empire.

To know who rules over you. Simply find out who it is that you are not allowed to criticise.Voltaire

We, as White people, have been GAGGED!! Then bullied, insulted, demonised, and provoked, until we object and complain. We then get called *dirty names* like Nazi, Racist, White Extremist, etc, etc.

Our weak & corrupt Lib/Lab/Con Politicians are the problem. As of Jan 2021, the UK elections are years away. Check out Populism, and Nationalism ASAP. Become "WHITE WOKE" & Push Back.

Do it today, NOW!

and if more people knew that he trafficked in African slaves and Indians (600 of whom he enslaved and brought to Europe)—he would probably be labeled an “African” slave trader as well.

Once they muscled into monopoly positions in trade, the lancados brought in European weapons to foment strife and wars between African tribes. This led to massive disruptions of African societies and the displacement of whole populations, as the transfer of captives, fueling the traffic in African human beings. This leads us to the important question of whether or not the “selling” of human beings was understood by the African tribal leaders to mean the kind of unspeakable cruelty and lifelong multi-generational bondage that Blacks experienced in the West. The answer is an emphatic NO! The labor systems practiced throughout the world for millennia (apprenticeship, peasantry, serfdom, indentureship, feudalism, tenant farming, sharecropping, etc.) had never had the dehumanizing commercial features that were a distinctive part of the Trans-Atlantic Slave Trade. Its horrifying brutality on a massive scale is entirely unique.

The term slavery itself has been strategically corrupted to include every labor system, no matter the nature of it or its severity. For instance, in some “slave” systems the “slave” had full legal rights and could negotiate the terms of his labor, including the time and compensation; some “slaves” could sue in court and could inherit property; some could ultimately take over their master’s business and even marry the master’s daughter. In one so-called slave society, it was believed that “when one gains a slave, he gains a son.” The “slave” had to eat and sleep in the same manner as the master. Even the Biblical story of Joseph being sold into slavery by his own brothers resulted in a “slave” becoming the most powerful man in Egypt next to Pharaoh. NONE of these humane features characterized slavery in the Americas!

The variety of slavery that developed in the isolation of the sugar islands off the African coast was entirely unprecedented and unknown. It was a new, dark element that injected medieval monstrosities into an agrarian culture of farmers that had never seen such atrocities before the European lancado invasion. It was a true slavery, a horrific slavery, under which its victims had no rights and no hope—by design.

So the “African” slave traders who “sold us out,” upon closer examination were actually half-European by blood and totally European by mentality. Our African spirit of welcoming every people regardless of color made the African people vulnerable to this wicked “half-original” incursion, and we have been paying a high price for it ever since.



William Wilberforce

On Friday July 26th 1833 as he lay on his deathbed Wilberforce exclaimed: "Thank God that I have lived to witness the day in which England is willing to give £20 million for the abolishment of slavery." (What would that be worth today ?) He died three days later.

The Slavery Abolition Bill 1833 passed through the House of Lords, it received the Royal Assent (which means it became law) on 29 August 1833 and came into force on 1 August 1834. On that date slavery was abolished throughout the vast British Empire. The Act automatically applied as new possessions (principally in Africa) subsequently became part of the British Empire.

To know who rules over you. Simply find out who it is that you are not allowed to criticise.Voltaire

We, as White people, have been GAGGED!! Then bullied, insulted, demonised, and provoked, until we object and complain. We then get called *dirty names* like Nazi, Racist, White Extremist, etc, etc.

Our weak & corrupt Lib/Lab/Con Politicians are the problem. As of Jan 2021, the UK elections are years away. Check out Populism, and Nationalism ASAP. Become "WHITE WOKE" & Push Back.

Do it today, NOW!

Europeans

From http://www.nationalarchives.gov.uk/pathways/blackhistory/africa_caribbean/africa_trade.htm

Before the 16th century, Europeans were not deeply involved in slave trading on the West African coast. However, there was some movement of African labour to Madeira and the Canary Islands by the early Portuguese explorers from 1470 onwards. The Portuguese were also the first to use African slave labour in gold mines, and on sugar plantations on the small equatorial island of São Tomé. These plantations became the model for future sugar estates in the West Indies. African exports at this time included gold, palm oil, nuts, yams, pepper, ivory, gum and cloth.

During the 16th century the first foundations of globalisation were laid when African rulers forged relationships with European traders. One early English explorer was William Hawkins, father of John Hawkins. In the 1530s, Hawkins made voyages to Guinea to obtain ivory. At this stage the English seemed to have little interest in taking slaves. This, however, was soon to change.

There was intense rivalry for West Africa among Europeans. With no interest in conquering the interior, they concentrated their efforts to obtain human cargo along the West African coast. During the 1590s, the Dutch challenged the Portuguese monopoly to become the main slave trading nation. Later, Scottish, Swedish and Danish African companies registered their interest. With so many European powers on the coast, conflict was inevitable, culminating in the Anglo-Dutch war of 1665-7. Forts built by the Portuguese and Dutch on the Gold Coast (modern Ghana) were captured by the British in 1667.

Slaves for Guns

West African rulers were instrumental in the slave trade. They exchanged their prisoners of war (rarely their own people) for firearms manufactured in Birmingham and elsewhere in Britain. With their newly acquired weapons, kings and chiefs were able to expand their territories. The slave trade had a profound effect on the economy and politics of West Africa, leading, in many cases, to an increase in tension and violence.

In 1650, for example, Dahomey, a small coastal state on the Atlantic, extended its borders into the interior of Africa. Half a century later, the Asante Empire under Osei Tutu forcibly united a number of small kingdoms into a strong federation. A large proportion of the prisoners of war were sold on as slaves. Other Africans captured during raids into the interior were exchanged for commodities.

Europeans lacked the local knowledge to be able to negotiate the perils of the African interior, so they used middlemen for this task, Olaudah Equiano, who had himself been captured in this way. European slaving ships waited at coastal ports to pick up their cargoes of slaves. Middlemen would attack Africans working in the fields and march them to the coast. Children acting as lookouts for their parents might also be captured.

The captured Africans were held in forts, sometimes called 'slave castles', along the coast. They remained there for months until finally leaving their homeland for an unknown destination on board European merchant ships, including those of the British Royal African Company. Ships constructed in Britain carried the Africans to the West Indies. This human cargo of slaves was chained at the wrists and legs with irons, and stowed in the lower decks of the ships, like any other commodity.

The slave trade developed into a complex system that included many different groups and interests. The actual number of Africans taken continues to be disputed, but it is somewhere in the range of 15 to 20 million people. It has been suggested that a great many of those captured went unrecorded. Many died on the march to the coast, in the cellars of slave forts and on the ships.

The slave trade was responsible for major disruption to the people of Africa. Women and men were taken young, in their most productive years, thus damaging African economies. The physical experience of slavery was painful, traumatic and long-lasting. We know this from the written evidence of several freed slaves. Captivity marked the beginning of a dehumanising process that affected British attitudes towards African people.



William Wilberforce
On Friday July 26th 1833 as he lay on his deathbed Wilberforce exclaimed: "Thank God that I have lived to witness the day in which England is willing to give £20 million for the abolishment of slavery." (What would that be worth today ?)
He died three days later.

The Slavery Abolition Bill 1833 passed through the House of Lords, it received the Royal Assent (which means it became law) on 29 August 1833 and came into force on 1 August 1834. On that date slavery was abolished throughout the vast British Empire. The Act automatically applied as new possessions (principally in Africa) subsequently became part of the British Empire.

To know who rules over you. Simply find out who it is that you are not allowed to criticise.Voltaire

We, as White people, have been GAGGED!! Then bullied, insulted, demonised, and provoked, until we object and complain. We then get called *dirty names* like Nazi, Racist, White Extremist, etc, etc.

Our weak & corrupt Lib/Lab/Con Politicians are the problem. As of Jan 2021, the UK elections are years away. Check out Populism, and Nationalism ASAP. Become "WHITE WOKE" & Push Back.

Do it today, NOW!



As in most of the world, slavery, or involuntary human servitude, was practiced across Africa from prehistoric times to the modern era.

From <http://autocww.colorado.edu>

I. Introduction

Slavery in Africa, the institution of slavery as it existed in Africa, and the effects of world slave-trade systems on African people and societies. As in most of the world, slavery, or involuntary human servitude, was practiced across Africa from prehistoric times to the modern era. When people today think of slavery, many envision the form in which it existed in the United States before the American Civil War (1861-1865): one racially identifiable group owning and exploiting another. However, in other parts of the world, slavery has taken many different forms. In Africa, many societies recognized slaves merely as property, but others saw them as dependents who eventually might be integrated into the families of slave owners. Still other societies allowed slaves to attain positions of military or administrative power. Most often, both slave owners and slaves were black Africans, although they were frequently of different ethnic groups. Traditionally, African slaves were bought to perform menial or domestic labor, to serve as wives or concubines, or to enhance the status of the slave owner.

Traditional African practices of slavery were altered to some extent beginning in the 7th century by two non-African groups of slave traders: Arab Muslims and Europeans. From the 7th to the 20th century, Arab Muslims raided and traded for black African slaves in West, Central, and East Africa, sending thousands of slaves each year to North Africa and parts of Asia. From the 15th to the 19th century, Europeans bought millions of slaves in West, Central, and East Africa and sent them to Europe; the Caribbean; and North, Central, and South America. These two overlapping waves of transcontinental slave trading made the slave trade central to the economies of many African states and threatened many more Africans with enslavement.

II. Traditions of Slavery Within Africa

Slavery existed in some of Africa's earliest organized societies. More than 3,500 years ago, ancient Egyptians raided neighboring societies for slaves, and the buying and selling of slaves were regular activities in cities along the Nile River. However, whereas the Egyptians left behind written records of their activities, most other early African states and societies did not. Therefore, our understanding of most early African practices of slavery is based on much more recent observations of African traditions regarding slavery and kinship and on oral

histories.

A. Origins

In Africa, as in many places around the world, early slavery likely resulted from warring groups taking captives. Such captives were of little use, and often some bother, when kept close to their homes because of the ease of escape. Therefore, they were often sold and transported to more distant places.

Warfare was not the only reason for the practice of slavery in Africa, however. In many African societies, slavery represented one of the few methods of producing wealth available to common people. Throughout the African continent there was little recognition of rights to private landholding until colonial officials began imposing European law in the 19th century. Land was typically held communally by villages or large clans and was allotted to families according to their need. The amount of land a family needed was determined by the number of laborers that family could marshal to work the land. To increase production, a family had to invest in more laborers and thus increase their share of land. The simplest and quickest way to do this was to invest in slaves. To help service this demand, many early African societies conducted slave raids on distant villages.

B. Slaves' Roles

Women constituted the majority of early African slaves. In addition to agricultural work, female slaves carried out other economic functions, such as trading and cotton spinning and dyeing. They also performed domestic chores, such as preparing food, washing clothes, and cleaning. Powerful African men kept female slaves as wives or concubines, and in many societies these women stood as symbols of male wealth. Male slaves typically farmed and herded animals. Those who belonged to wealthy families and especially of ruling lineages of states also worked as porters and rowers, and learned crafts such as weaving, construction, and metalwork. New slaves were sometimes given menial tasks while experienced slaves did the more difficult and dangerous work, such as mining and quarrying.

Some male, and fewer female, slaves held positions of high status and trust within their societies. In precolonial states in the interior of West and Central Africa, slaves often served as soldiers and confidants of high officials. With their necessarily limited ambitions and dependence on their masters, slaves were considered the ideal persons to be close to men in power. In a few cases, female slaves assumed power and influence as well. For example, in the 19th century in the West African Kingdom of Dahomey (now southern Benin), women served in the royal palace and formed the kingdom's soldier elite.

C. Slavery and Kinship

Kinship (connection to a family by blood or marriage) has always been extremely important in Africa as an essential component of a person's identity and ability to



William Wilberforce

On Friday July 26th 1833 as he lay on his deathbed Wilberforce exclaimed: "Thank God that I have lived to witness the day in which England is willing to give £20 million for the abolishment of slavery." (What would that be worth today ?) He died three days later.

The Slavery Abolition Bill 1833 passed through the House of Lords, it received the Royal Assent (which means it became law) on 29 August 1833 and came into force on 1 August 1834. On that date slavery was abolished throughout the vast British Empire. The Act automatically applied as new possessions (principally in Africa) subsequently became part of the British Empire.

To know who rules over you. Simply find out who it is that you are not allowed to criticise.Voltaire

We, as White people, have been GAGGED!! Then bullied, insulted, demonised, and provoked, until we object and complain. We then get called *dirty names* like Nazi, Racist, White Extremist, etc, etc.

Our weak & corrupt Lib/Lab/Con Politicians are the problem. As of Jan 2021, the UK elections are years away. Check out Populism, and Nationalism ASAP. Become "WHITE WOKE" & Push Back.

Do it today, NOW!



William Wilberforce

On Friday July 26th 1833 as he lay on his deathbed Wilberforce exclaimed: "Thank God that I have lived to witness the day in which England is willing to give £20 million for the abolishment of slavery." (What would that be worth today ?) He died three days later.

The Slavery Abolition Bill 1833 passed through the House of Lords, it received the Royal Assent (which means it became law) on 29 August 1833 and came into force on 1 August 1834. On that date slavery was abolished throughout the vast British Empire. The Act automatically applied as new possessions (principally in Africa) subsequently became part of the British Empire.

To know who rules over you. Simply find out who it is that you are not allowed to criticise.Voltaire

We, as White people, have been GAGGED!! Then bullied, insulted, demonised, and provoked, until we object and complain. We then get called *dirty names* like Nazi, Racist, White Extremist, etc, etc.

Our weak & corrupt Lib/Lab/Con Politicians are the problem. As of Jan 2021, the UK elections are years away. Check out Populism, and Nationalism ASAP. Become "WHITE WOKE" & Push Back.

Do it today, NOW!

survive in society. Traditionally, those without kin were essentially lost—not considered real persons by society. Slaves, taken in battle or in slave raids, were cut off from their kin. In some societies, however, slaves were viewed as dependents, and could, over time, become identified as members of their owners' extended families. Many African societies decreed that children of slave owners by their slaves could not be sold or killed. Also, after three or four generations, descendants of slaves could often shed their slave status. Thus slavery, on one hand, cut people off from their kin but, on the other hand, provided them with the possibility of becoming attached to other families and, after several generations, reintegrated into the web of kinship.

None of the above possibilities should suggest that enslaved Africans liked what was happening to them, accepted slavery willingly, or normally rose quickly in status. However, early African traditions of slavery appear more benign when compared to the institutionalized systems of slave trading that would develop later. As African states began providing slaves for export by Arabs or Europeans, slavery became much more central to the economies and politics of those states and more of a threat to Africans in general.

III. Effects of Slave Trades on Africa

Around the 15th century BC, Egypt's New Kingdom enslaved non-Africans, such as Jews from Palestine, through warfare and imported them to the Nile Valley. As an African importer of non-African slaves, however, ancient Egypt is a notable exception to the rule. Africa's role in the history of transcontinental slave trading has generally been as a provider or exporter of slaves for use outside of Africa.

After the 5th century BC, Greeks and, later, Romans came to dominate the Mediterranean Sea. Both of these slave-owning powers raided North Africa extensively for slaves. This practice of using Africa as a source of slaves would be adopted and expanded first by Arab Muslims and later by Europeans.

A. The Trans-Saharan and East African Slave Trades

The spread of Islam from Arabia into Africa after the religion's founding in the 7th century AD affected the practice of slavery and slave trading in West, Central, and East Africa. Arabs had practiced slave raiding and trading in Arabia for centuries prior to the founding of Islam, and slavery became a component of Islamic traditions. Both the Qur'an (Koran) (the sacred scripture of Islam) and Islamic religious law served to codify and justify the existence of slavery. As Muslim Arabs conquered their way westward across North Africa in the 7th and 8th centuries, their victorious leaders rewarded themselves with Berber captives, most of whom were eventually enrolled in Muslim armies. Over time, large segments of North Africa's Berber population converted to Islam. The religion spread to the camel

herders of the Sahara Desert, who were in contact with black Africans south of the Sahara and who traded small numbers of black slaves. Muslim Arabs expanded this trans-Saharan slave trade, buying or seizing increasing numbers of black Africans in West Africa, leading them across the Sahara, and selling them in North Africa. From there, most of these slaves were exported to far-off Asian destinations such as the eastern Mediterranean, Anatolia (in present-day Turkey), Arabia, Persia (present-day Iran), and India.

The trans-Saharan slave trade grew significantly from the 10th to the 15th century, as vast African empires such as Ghana, Mali, Songhai, and Kanem-Bornu developed south of the Sahara and marshaled the trade. Arab slave raiders also penetrated south, up the Nile River to present-day Ethiopia, capturing thousands of slaves and sending them down the Nile to Egypt. Over the course of more than a thousand years, the trans-Saharan slave trade saw the movement of at least 10 million enslaved men, women, and children from West and East Africa to North Africa, the Middle East, and India. The slaves and their descendants contributed to the harems, royal households, and armies of the Arab, Turkish, and Persian rulers in those regions.

Also, by the 9th century, seafaring Muslims from Arabia and Persia had made their way down the Indian Ocean coast of East Africa, obtaining African slaves in ports from Mogadishu (in present-day Somalia) to Sofala (in present-day Mozambique) and conveying them to western Asian cities to work. The culture of the East African coastal regions was strongly influenced by Arab and Persian traders, many of whom intermarried with Africans, thus producing the Swahili people and culture. Between the 9th and the 13th centuries, this Arab-Persian-Swahili population established cities and city-states along the East African coast. These cities and states captured or purchased slaves from the East African interior for domestic and agricultural tasks. In the 18th and 19th centuries, as plantation agriculture developed in the region, the East African slave trade increased dramatically.

Scholars' opinions differ on the issue of the long-term effects of Islam on African slavery. Some believe that Islamic law helped regulate slavery, thus limiting its abuses; these scholars often argue that because Islam encouraged the freeing of slaves upon their master's death, it increased instances of emancipation. Other scholars believe that Islam led to the expansion of slavery, arguing that at the time that slavery was growing in the parts of Africa coming under Islamic influence, slavery was declining in most of medieval Europe.

Between the 7th and the 15th century, the trans-Saharan and East African slave trades spurred the gradual expansion of slavery within Africa. The slave trades contributed to the development of powerful African states on the southern fringes of the Sahara and in the East African interior. The economies of these states were dependent on slave trading. Neighboring states competed with one another for trade, leading to wars, which in turn led to the capture of more slaves. Slave raiding in West, East, and Central Africa became more common and wide-ranging.



William Wilberforce

On Friday July 26th 1833 as he lay on his deathbed Wilberforce exclaimed: "Thank God that I have lived to witness the day in which England is willing to give £20 million for the abolishment of slavery." (What would that be worth today ?) He died three days later.

The Slavery Abolition Bill 1833 passed through the House of Lords, it received the Royal Assent (which means it became law) on 29 August 1833 and came into force on 1 August 1834. On that date slavery was abolished throughout the vast British Empire. The Act automatically applied as new possessions (principally in Africa) subsequently became part of the British Empire.

To know who rules over you. Simply find out who it is that you are not allowed to criticise.Voltaire

We, as White people, have been GAGGED!! Then bullied, insulted, demonised, and provoked, until we object and complain. We then get called *dirty names* like Nazi, Racist, White Extremist, etc, etc.

Our weak & corrupt Lib/Lab/Con Politicians are the problem. As of Jan 2021, the UK elections are years away. Check out Populism, and Nationalism ASAP. Become "WHITE WOKE" & Push Back.

Do it today, NOW!

When European explorers and traders arrived in West Africa beginning in the 15th century, they found and began using well-established slave-trade networks. While the trans-Saharan and East African slave trades continued until the early 20th century, they were overshadowed by the Atlantic slave trade after the 15th century. The Atlantic slave trade dwarfed the trans-Saharan and East African trades in terms of volume of export, impact on African practices of slavery, and lasting effect on Africa in general.

B. The Atlantic Slave Trade

The Atlantic slave trade developed after Europeans began exploring and establishing trading posts on the Atlantic (west) coast of Africa in the mid-15th century. The first major group of European traders in West Africa was the Portuguese, followed by the British and the French. In the 16th and 17th centuries, these European colonial powers began to pursue plantation agriculture in their expanding possessions in the New World (North, Central, and South America, and the Caribbean islands), across the Atlantic Ocean. As European demand grew for products such as sugar, tobacco, rice, indigo, and cotton, and as more New World lands became available for European use, the need for plantation labor increased.

West and west central African states, already involved in slave trading, supplied the Europeans with African slaves for export across the Atlantic. Africans tended to live longer on the tropical plantations of the New World than did European laborers (who were susceptible to tropical diseases) and Native Americans (who were extremely susceptible to "Old World" diseases brought by the Europeans from Europe, Asia, and Africa). Also, enslaved men and women from Africa were inexpensive by European standards. Therefore, Africans became the major source, and eventually the only source, of New World plantation labor.

The Africans who facilitated and benefited from the Atlantic slave trade were political or commercial elites—generally members of the ruling apparatus of African states or members of large trading families or institutions. African sellers captured slaves and brought them to markets on the coast. At these markets European and American buyers paid for the slaves with commodities—including cloth, iron, firearms, liquor, and decorative items—that were useful to the sellers. Slave sellers were mostly male, and they used their increased wealth to enhance their prestige and connect themselves, through marriage, to other wealthy families in their realms.

The Africans who were enslaved were mostly prisoners of war or captives resulting from slave raids. As the demand for slaves grew, so did the practice of systematic slave raiding, which increased in scope and efficiency with the introduction of firearms to Africa in the 17th century. By the 18th century, most African slaves were acquired through slave raids, which penetrated farther and farther inland. Africans captured in raids were marched down well-worn paths, sometimes for several hundred miles, to markets on the coast.

From the mid-15th to the late-19th century, European and American slave traders purchased approximately 12 million slaves from West and west central Africa. A

small percentage of these slaves, particularly in the early years of the trade, were sent to Europe, especially to Spain and Portugal. Most, however, were shipped across the Atlantic for sale in Portuguese-administered Brazil; the British, French, Dutch, and Danish islands of the Caribbean; Spanish-controlled South and Central America; and the British North American mainland (later the United States and Canada). The Atlantic crossing, known as the Middle Passage, was nightmarish for slaves, who were poorly fed, subject to abuses at the hands of the crew, and confined to cramped storage holds in which diseases spread easily. Historians estimate that between 1.5 and 2 million slaves died during the journey to the New World.

The Atlantic slave trade differed from previous practices of slavery and slave trading in Africa in its huge scope and its importance to the economies of world powers. While traditional African slavery was practiced largely to help African communities produce food and goods or for prestige, slave labor on European plantations in the New World was crucial to the economies of the colonies and therefore to the economies of the colonial powers. This global economic demand for African slaves altered African practices of slavery. In much of Africa, slavery became a more central, structural element of African life, as rulers and wealthy elites sought to accumulate more and more slaves, for sale as well as for their own use. In addition to the systematic and institutional practice of slave raiding, other practices were introduced in African states to bring in even more slaves, including enslavement as punishment for crimes and religious wrongdoing. As a result, by the 19th century vast numbers of black Africans in West and Central Africa faced the threat of being enslaved.

IV. The End of Slavery in Africa

As humanitarian sentiments grew in Western Europe with the 18th-century Age of Enlightenment and as European economic interests shifted slowly from agriculture to industry, a movement to abolish the slave trade and the practice of slavery came into being in the Western world. In 1807 the slave trade was outlawed in Britain and the United States. Britain outlawed the practice of slavery in all British territory in 1833; France did the same in its colonies in 1848. In 1865, following the American Civil War, the U.S. government adopted the 13th Amendment to the Constitution, ending slavery in the United States. The Atlantic slave trade continued, however, until 1888, when Brazil abolished slavery (the last New World country to do so).

While the Atlantic slave trade was dying down around 1850, the trans-Saharan and East African slave trades were at their peaks. In the 1850s the Ottoman Empire nominally outlawed slavery in much of the Islamic world, but this had only a minor effect on the slave trade. One of the main justifications European powers gave for colonizing nearly the entire African continent during the 1880s and 1890s was the desire to end slave trading and slavery in Africa. By the dawn of the 20th century, European forces had defeated most African slave trading states, and the trans-Saharan and East African slave trades came to an end.

Although colonial authorities began outlawing slavery in some African territories as early as the 1830s, the complete legal abolition of slavery in Africa did not take place until the first quarter of the 20th century. By that time, however, slavery was deeply ingrained in most African societies, and thus the practice continued illegally. Slaves who became liberated often did so by escaping and going to the colonial authorities or by simply leaving the areas in which they had been held to take up residence elsewhere. In some places, enslaved persons held that status throughout their lives, despite the legal prohibition. It was not until the 1930s that slavery in Africa was almost totally eliminated.

The ending of the slave trade and slavery in Africa had wide-ranging effects on the African continent. Many societies that for centuries had participated in an economy based on slave labor and the trading of slaves had difficulty finding new ways to organize labor and gain wealth. Meanwhile, colonial governments in Africa that outwardly disapproved of slavery still needed inexpensive laborers for agriculture, industry, and other work projects. As a result, African leaders and former slave owners, as well as colonial officials, often developed methods of coercing Africans to work without pay or for minimal compensation. Moreover, the outlawing of slavery did not erase the pain and stigma of having been a slave. Many descendants of slaves were affected by this stigma for generations after slavery was abolished.



William Wilberforce

On Friday July 26th 1833 as he lay on his deathbed Wilberforce exclaimed: "Thank God that I have lived to witness the day in which England is willing to give £20 million for the abolishment of slavery." (What would that be worth today ?)

He died three days later.

The Slavery Abolition Bill 1833 passed through the House of Lords, it received the Royal Assent (which means it became law) on 29 August 1833 and came into force on 1 August 1834. On that date slavery was abolished throughout the vast British Empire.

The Act automatically applied as new possessions (principally in Africa) subsequently became part of the British Empire.

To know who rules over you. Simply find out who it is that you are not allowed to criticise.Voltaire

We, as White people, have been GAGGED!! Then bullied, insulted, demonised, and provoked, until we object and complain. We then get called *dirty names* like Nazi, Racist, White Extremist, etc, etc.

Our weak & corrupt Lib/Lab/Con Politicians are the problem. As of Jan 2021, the UK elections are years away. Check out Populism, and Nationalism ASAP. Become "WHITE WOKE" & Push Back.

Do it today, NOW!

The Truth About Slavery

Program of 2d April, 1993

From www.natall.com

The history of America and of Western Civilization is not being taught as it should be in our schools and universities today. Historical facts are suppressed, and what is taught is distorted in such a way as to advance the world government agenda, with all inconvenient historical facts, knowledge of which might cause our young people to question that agenda, purposely left out.

It is a tragedy of monumental proportions that our schools have been converted into "liberal" brainwashing institutions, though I do feel a sense of encouragement when I read that more and more real Americans are taking their children out of the public schools and teaching them at home. As regular listeners to this program know, the global elite that push multiculturalism push it because it undermines our national and racial sense of identity, and not out of any love or concern for ethnic minorities. In fact, it should be obvious to everyone that multiculturalism and globalism threaten the racial and cultural integrity of all peoples, not just White Americans. Nevertheless, because America is, or was until recently, a predominantly White nation, one of the primary ways that national disintegration is promoted by the destroyers of nations in this country is by the inculcation of White guilt for Black slavery.

By recounting and emphasizing again and again the real and imagined sufferings of Black people under slavery, the White student is made to feel that his ancestors were cruel, morally retarded, and evil. They are made to feel that they owe Black people a nearly infinite compensation, since, they are taught, Black people's problems today are the legacy of hundreds of years of slavery for which White people are responsible. They are taught that the relative prosperity which we enjoy today was achieved largely by exploitation of Black slaves. Is it any wonder that thousands of our young people join Jesse Jackson in chanting "Hey Hey Ho Ho, Western Culture's Gotta Go"? Is it any wonder that they all too often reject our European cultural heritage and embrace all forms of alien styles of music, dancing, dress, grooming and slang, from Jamaican "rasta" to "gangsta rap"? Is it any wonder that White teenagers are committing suicide in higher numbers every year? They have received, in our public schools and colleges, not a "liberal education," but an education by liberals. They have been taught very well indeed - taught that they and their ancestors and their traditions and their natural feelings are worthless and an obstacle to be overcome.

Now these liberal lies are easily countered by facts. The primary fact that must be emphasized is that many hundreds of thousands of White people were slaves in

early America. In fact, White slavery was not only extremely common, but until the late 18th century it was far more common than Black slavery here. Also little known is the fact that living and labor (Labour) conditions for Black slaves, bad as they often were, were usually far better than those for White slaves.

At this point, many of you are probably saying "White slaves? What in the world is he talking about? Sure, there were White indentured servants and apprentices in colonial America, and maybe sometimes they were treated badly, but actual White slavery - that's something that disappeared with the Romans and the Vikings. And to compare White indentured servants to Black slaves is the worst sort of racist distortion of history!"

Some of you are probably saying or thinking exactly that, and quite frankly to most of us the idea of White slavery in early America is hard to accept, schooled as we are by the controlled media and the liberal-dominated public schools. But researcher and writer Michael Hoffman has recently come out with one of the most earth-shaking works of historical research in the last decade, entitled *They Were White and They Were Slaves*. This program is based on Mr. Hoffman's original research into documents long hidden from the public eye and revealing a very different America from that presented in the controlled media.

(Following from TWWATWS)

There is a history of White people that has never been told in any coherent form, largely because most modern historians have, for reasons of politics or psychology, refused to recognize White slaves in America as just that. Today, not a tear is shed for the sufferings of millions of our enslaved forefathers. 200 years of White slavery in America have been almost completely obliterated from the collective memory of the American people.

Writer Elaine Kendall asks "Who wants to be reminded that half - perhaps as many as two-thirds - of the original American colonists came here, not of their own free will, but kidnapped, shanghaied, impressed, duped, beguiled, and yes, in chains - ? ...we tend to gloss over it... we'd prefer to forget the whole sorry chapter."

A correct understanding of the authentic history of the enslavement of Whites in America could have profound consequences for the future. Most of the books on White labor (Labour) in early America use words like "White indentured servitude," "White bondservants," "White servants," etc. Few are now aware that the majority of these so-called "servants" were bound to a condition more properly called permanent chattel slavery unto death. The papers legally allowing the enslavement, called indentures, were often forged by kidnappers and press-gangs; and in cases where these papers did not literally specify a life term of servitude, the slave-owner had the legal right to unilaterally increase the length of the term on the flimsiest pretexts. The so-called "apprentices" or "indentured servants" had no say in the matter. These enslaved White people are, however, never called slaves by establishment academics and media spokesmen. To do so

Home  Index



William Wilberforce

On Friday July 26th 1833 as he lay on his deathbed Wilberforce exclaimed: "Thank God that I have lived to witness the day in which England is willing to give £20 million for the abolishment of slavery." (What would that be worth today ?) He died three days later.

The Slavery Abolition Bill 1833 passed through the House of Lords, it received the Royal Assent (which means it became law) on 29 August 1833 and came into force on 1 August 1834. On that date slavery was abolished throughout the vast British Empire. The Act automatically applied as new possessions (principally in Africa) subsequently became part of the British Empire.

To know who rules over you. Simply find out who it is that you are not allowed to criticise.Voltaire

We, as White people, have been GAGGED!! Then bullied, insulted, demonised, and provoked, until we object and complain. We then get called *dirty names* like Nazi, Racist, White Extremist, etc, etc.

Our weak & corrupt Lib/Lab/Con Politicians are the problem. As of Jan 2021, the UK elections are years away. Check out Populism, and Nationalism ASAP. Become "WHITE WOKE" & Push Back.

Do it today, NOW!

would destroy the myth of unique Black victimhood and universal White guilt.

Today, with the massive concentration of educational and media resources on the Black experience of slavery, the unspoken assumption has been that only Blacks have been enslaved to any degree or magnitude worthy of study or memorial. The historical record reveals that this is not the case, however. The word "slave" itself is derived from the word "slav," a reference to the Eastern European White people who, among others, were enslaved by their fellow Whites, by the Mongols, and by the Arabs over a period of many centuries.

According to Thomas Burton's Parliamentary Diary 1656-1659, in 1659 the English parliament debated the practice of selling British Whites into slavery in the New World. In the debate, these Whites were referred to not as "indentured servants" but as "slaves."

In the Calendar of State Papers, Colonial Series, America and West Indies of 1701, we read of a protest over the "encouragement to the spiriting away of Englishmen without their consent and selling them for slaves, which hath been a practice very frequent and known by the name of kidnapping." In the British West Indies, plantation slavery was instituted as early as 1627. In Barbados by the 1640s there were an estimated 25,000 slaves, of whom 21,700 were White.

This document records that while White slaves were worked to death, as they cost next to nothing, there were Caribbean Indians brought from Guiana to help propagate native foodstuffs who were well-treated and received as free persons by the wealthy planters.

The Englishman William Eddis, after observing White slaves in America in the 1770s wrote: "Generally speaking, they groan beneath a worse than Egyptian bondage." Governor Sharpe of the Maryland colony compared the property interest of the planters in their White slaves, with the estate of an English farmer consisting of a "Multitude of Cattle."

Lay historian Col. A. B. Ellis, writing in the British Newspaper Argosy for May 6, 1893, said: "Few, but readers of old colonial state papers and records, are aware that between the years 1649 to 1690 a lively trade was carried on between England and the plantations, as the colonies were then called, [a trade] in political prisoners... they were sold at auction... for various terms of years, sometimes for life, as slaves."

Sir George Sandys' 1618 plan for Virginia referred to bound Whites assigned to the treasurer's office to "belong to said office forever." The service of Whites bound to Berkeley's Hundred was deemed "perpetual."

Numerous documents from the seventeenth, eighteenth, and even nineteenth

centuries reveal that these Whites in bondage certainly referred to themselves as slaves, and there are even records of Blacks referring to them as "White slaves."

Did you know that the expression "kidnapping," (originally kid-nabbing) had its origin in the abduction of poor White children to be sold into factory slavery in Britain or plantation slavery in America? Did you know that the expression "spirited away" likewise originated with the White slavers, who were also called "spirits"?

The White slavery in America was but an extension of the White slavery in the mother country, Britain, where the legal form of contracted indentured servitude and apprenticeship was maintained as a spurious cover for plain and simple lifetime chattel slavery. Particularly shocking was the enslavement of White children for factory labor (Labour). Children were openly seized from orphanages and workhouses and placed in the factories.

In Brian Inglis' Poverty and the Industrial Revolution we read: "Here then was a ready source of labor (Labour) - and a very welcome one. The children were formally indentured as apprentices... What happened to them was nobody's concern. A parish in London, having got rid of a batch of unwanted pauper children, was unlikely to interest itself in their subsequent fate... The term 'apprenticeship' was in any case a misnomer...."

In Marjorie Cruikshank's Children and Industry: "many employers imported child apprentices, parish orphans from workhouses far and near. Clearly, overseers of the poor were only too keen to get rid of the orphans... children were brought (to the factories) like 'cartloads of live lumber' and abandoned to their fate... poor children, taken from workhouses or kidnapped in the streets of the metropolis, used to be brought down by... coach to Manchester and slid into a cellar in Mosley Street as if they had been stones or any other inanimate substance."

White children worked up to sixteen hours a day and during that period the doors were locked. Children - and most of the mill workers were children - were allowed out only to 'go to the necessary.' In some factories it was forbidden to open the windows... The child 'apprentices' who were on night shift might have to stay on it for as long as four or five years. They were lucky if they were given a half penny an hour.

This was labor (Labour) without any breaks - unceasing labor (Labour). When the children fell asleep at the machines, they were lashed into wakefulness with a whip. If they arrived late to the factory, talked to another child, or committed some other infraction they were beaten with an iron bar known as a "billy-roller," eight feet long and one inch and a half in diameter. Many were thus murdered, often for trifling offenses such as calling out names to the next child.



William Wilberforce

On Friday July 26th 1833 as he lay on his deathbed Wilberforce exclaimed: "Thank God that I have lived to witness the day in which England is willing to give £20 million for the abolishment of slavery." (What would that be worth today ?)

He died three days later.

The Slavery Abolition Bill 1833 passed through the House of Lords, it received the Royal Assent (which means it became law) on 29 August 1833 and came into force on 1 August 1834.

On that date slavery was abolished throughout the vast British Empire. The Act automatically applied as new possessions (principally in Africa) subsequently became part of the British Empire.

To know who rules over you. Simply find out who it is that you are not allowed to criticise.Voltaire

We, as White people, have been GAGGED!! Then bullied, insulted, demonised, and provoked, until we object and complain. We then get called *dirty names* like Nazi, Racist, White Extremist, etc, etc.

Our weak & corrupt Lib/Lab/Con Politicians are the problem. As of Jan 2021, the UK elections are years away. Check out Populism, and Nationalism ASAP. Become "WHITE WOKE" & Push Back.

Do it today, NOW!

**William Wilberforce**

On Friday July 26th 1833 as he lay on his deathbed Wilberforce exclaimed: "Thank God that I have lived to witness the day in which England is willing to give £20 million for the abolishment of slavery." (What would that be worth today ?)

He died three days later.

The Slavery Abolition Bill 1833 passed through the House of Lords, it received the Royal Assent (which means it became law) on 29 August 1833 and came into force on 1 August 1834. On that date slavery was abolished throughout the vast British Empire.

The Act automatically applied as new possessions (principally in Africa) subsequently became part of the British Empire.

To know who rules over you. Simply find out who it is that you are not allowed to criticise.Voltaire

We, as White people, have been GAGGED!! Then bullied, insulted, demonised, and provoked, until we object and complain. We then get called *dirty names* like Nazi, Racist, White Extremist, etc, etc.

Our weak & corrupt Lib/Lab/Con Politicians are the problem. As of Jan 2021, the UK elections are years away. Check out Populism, and Nationalism ASAP. Become "WHITE WOKE" & Push Back.

Do it today, NOW!

bear burdens of guilt and monetary reparation for Black slavery. This position is based entirely on enforced ignorance and the deliberate suppression of the record of White slavery in North America.

Reparations? Welfare and affirmative action as compensation for past slavery? Leaving aside for the moment the very questionable idea of punishing the great-grandson for the sins of the great-grandfather, let us consider the principles involved. Far more Whites in America are descendants of White slaves than are descendants of slave owners. And considering the endemic nature of slavery in Black Africa, it is quite likely that a large proportion of Blacks in America have ancestors who were themselves slave owners. So let us hear no more of White

Marxist Generals - Ethnic Soldiers - White Victims - Worldwide



Thousands of children were mangled or mutilated by the primitive factory machinery every year. They were often disfigured or disabled for life, then abandoned, receiving no compensation of any kind. Similar conditions obtained for enslaved White children on this side of the Atlantic, as what William Blake called "these Satanic Mills" spread to our shores.

Historian Oscar Handlin writes that in colonial America, White servants could be bartered for a profit, sold to the highest bidder for the unpaid debts of their masters, and otherwise transferred like moveable goods or chattels...

The controlled media focus exclusively on the enslavement of Blacks.

The impression is given that only Whites bear responsibility for enslaving Blacks and that only Blacks were slaves.

In fact, Blacks in Africa engaged in extensive enslavement of their own kind. Slavery was endemic in Africa, with entire tribes being enslaved through conquest on a regular basis.

When Arabic, Jewish and White slave traders arrived on the coast of sub-Saharan Africa, they seldom if ever had to travel inland and fight or pursue their quarry. They were met on the coast by Africans more than willing to sell slaves to them by the thousands. And in America, records show that Black slaves were owned, not just by a few wealthy Whites, but by free Blacks and by Cherokee Indians.

In some cases, these Blacks and Indians even owned White slaves.

White slaves were actually owned by Blacks and Indians in the South to such an extent that the Virginia Assembly passed the following law in 1670: "It is enacted that no negro or Indian though baptized and enjoying their own freedom shall be capable of any such purchase of Christians." The records of the time reveal that free Blacks often owned Black slaves themselves.

In 1717, it was proposed that a qualification for election to the South Carolina Assembly was to be "the ownership of one White man."

From 1609 until the early 1800s, between one half and two thirds of all the White colonists who came to the New World came as slaves. White slaves cleared the forests, drained the swamps, built the roads, sweated in the fields, and died like flies in hellish factories. Owned like property, they had no rights nor recourse to the law. Fugitive slave laws applied to them just as to Blacks if they should flee their masters. Black slaves were expensive, and though at times cruelly used, were not often used beyond the limits of human endurance. That would have been a waste of a costly investment. White slaves, however, consisting of the poor and unwanted "surplus population" of Britain, were available for nearly nothing, just a few pence for a thug to billyclub them and shanghai them aboard a westward-bound vessel. Thus they were expendable.

Both psychologically and materially Whites in modern times are called upon to

Slavery: White Slaves African Masters



William Wilberforce

On Friday July 26th 1833 as he lay on his deathbed Wilberforce exclaimed: "Thank God that I have lived to witness the day in which England is willing to give £20 million for the abolishment of slavery." (What would that be worth today?)

He died three days later.

The Slavery Abolition Bill 1833 passed through the House of Lords, it received the Royal Assent (which means it became law) on 29 August 1833 and came into force on 1 August 1834.

On that date slavery was abolished throughout the vast British Empire.

The Act automatically applied as new possessions (principally in Africa) subsequently became part of the British Empire.

To know who rules over you. Simply find out who it is that you are not allowed to criticise.

.....Voltaire

We, as White people, have been GAGGED!! Then bullied, insulted, demonised, and provoked, until we object and complain. We then get called *dirty names* like Nazi, Racist, White Extremist, etc, etc.

Our weak & corrupt Lib/Lab/Con Politicians are the problem. As of Jan 2021, the UK elections are years away. Check out Populism, and Nationalism ASAP. Become "WHITE WOKE" & Push Back.

Do it today, NOW!

governments in exchange for "peace treaties" that were supposed to halt the pirate attacks on their trading and naval ships. Those nations who did not pay suffered the consequences. Second, enslaved Europeans and Americans were often redeemed for a handsome ransom. And third, even if the Muslim governments received no "tribute" or ransom, they still benefited from the unpaid labor of their captives.

Baepler quotes a Barbary Coast maxim that illustrates the viewpoints of the pirates and their sponsoring states: "The Christians who would be on good terms with [the Barbary States] must [either] fight well or pay well."

The first-person narratives reproduced in this book do not support the often-repeated contention that slavery was somehow a more human institution in the Islamic world than it was in the European colonies of the New World.

By and large, the Christian slaves were poorly fed and housed, existing, by one account, on a meager ration of two slices of bread and a small quantity of beans per day. Clothing – and medical care -- was provided by sympathetic free Europeans living in North Africa; slave-owners provided nothing. Spanish Catholic priests even built a large hospital in Algeria to look after ill and dying Christian slaves.

The most popular punishment was the "bastinado" – hundreds of blows on the soles of the feet with a thick wooden truncheon. For more severe offenses, such as attempting to escape or ridiculing the Muslim religion or prophet, slaves were executed in particularly cruel ways: by crucifixion, burning at the stake or impalement on huge iron hooks until death. The narrators of these slave accounts witnessed many acts of brutality toward the Christian slaves, as well as toward the general North African populace ruled over by the elite: the beys, deys and bashaws of the Barbary States.

Baepler quotes from, but does not include, the narrative of one James Riley, an American Barbary captive of the early 1800s who published a book about his experiences upon returning to the United States. The book became an influential "best-seller" in the young nation of the USA and influenced those Americans who worked for abolition of the shameful practice of Black African slavery in the Southern States of the USA. Riley's book was said to have greatly influenced one young lawyer named Abraham Lincoln, who, as 16th president of the United States, signed the Emancipation Proclamation abolishing slavery in the U.S. in 1863.

As for the Barbary pirate slave trade, it continued sporadically up until the dawn of the 20th Century, and was not abolished until military and economic pressure was applied by the colonial powers of Europe (with, in some cases, assistance from the military might of the USA).

The most famous of all white Christian Europeans to serve as a slave in the Barbary States was probably Miguel de Cervantes, the great Spanish author of the "Don Quixote" epic, who was taken as a slave in the late 1500s.

From <http://www.faithfreedom.org>

This book illuminates a subject once well-known in the history of the West but which is now somewhat neglected: the enslavement, over several centuries, of tens of thousands of white Christian Europeans and (later) Americans in Muslim North Africa -- or the so-called "Barbary" states of Morocco, Algeria, Tunisia and Tripoli. Over the course of 10 centuries, tens of thousands of these unfortunates became the possessions of Muslims in North Africa courtesy of the feared Barbary pirates. These pirates cruised the Mediterranean Sea and the Atlantic Ocean in search of European and, later, American ships to pillage and plunder.

Edited by a lecturer at the University of Minnesota, Paul Baepler, this book focuses on first-person accounts of American Christians who served as slaves to high-ranking Muslim officials in North Africa. Baepler also provides fascinating background commentary that puts the narratives into historical perspective. He includes two "fictional" narratives of female captives. (According to Baepler, Christian women captives of the Barbary states – unlike male captives – usually did not publish their testimonies under their real names, due to the fact that many of them had been "dishonored" by service in the harems of Barbary potentates.)

As Baepler notes in his introduction, Christian slaves of European ancestry were hardly an uncommon phenomenon in the Barbary States. The Barbary pirates were excellent seafarers and, from the Coasts of North Africa, sailed as far north as Iceland (where they went ashore and captured 800 slaves during one incident) and as far West as Newfoundland, Canada, where they pillaged more than 40 vessels at one time. By 1620, reports Baepler, there were more than 20,000 white Christian slaves in Algiers alone, and by the 1630s that number tolled more than 30,000 men and 2,000 women. The most famous of all white Christian Europeans to serve as a slave in the Barbary States was probably Miguel de Cervantes, the great Spanish author of the "Don Quixote" epic, who was taken as a slave in the late 1500s.

An Important Source of Revenue

European and (later on) American slaves appeared to have been important source of foreign revenue for the local economies for several centuries. First, European and (later) American governments paid huge sums in "tribute" to the Muslim

Barbary Pirates and English Slaves

by Ben Johnson

[Barbary Pirates and English Slaves](#)



For over 300 years, the coastlines of the south west of England were at the mercy of Barbary pirates (corsairs) from the coast of North Africa, based mainly in the ports of Algiers, Tunis and Tripoli. Their number included not only North Africans but also English and Dutch privateers. Their aim was to capture slaves for the Arab slave markets in North Africa.

The Barbary pirates attacked and plundered not only those countries bordering the Mediterranean but as far north as the English Channel, Ireland, Scotland and Iceland, with the western coast of England almost being raided at will.

Barbary pirate

Partly as a result of an inadequate naval deterrent, by the early 17th century the situation was so bad that an entry in the Calendar of State Papers in May 1625 stated, 'The Turks are upon our coasts. They take ships only to take the men to make slaves of them.'

Barbary pirates raided on land as well as at sea. In August 1625 corsairs raided Mount's Bay, Cornwall, capturing 60 men, women and children and taking them into slavery. In 1626 St Keverne was repeatedly attacked, and boats out of Looe, Penzance, Mousehole and other Cornish ports were boarded, their crews taken captive and the empty ships left to drift. It was feared that there were around 60 Barbary men-of-war prowling the Devon and Cornish coasts and attacks were now occurring almost daily.

Sir John Eliot, Vice Admiral of Devon, declared that the seas around England "seem'd theirs."

The situation was so bad that in December 1640 a Committee for Algiers was set up by Parliament to oversee the ransoming of captives. At that time it was reported that there were some 3,000 to 5,000 English people in captivity in Algiers. Charities were also set up to help ransom the captives and local fishing communities clubbed together to raise money to liberate their own.

In 1645, another raid by Barbary pirates on the Cornish coast saw 240 men, women and children kidnapped. The following year Parliament sent Edmund

Cason to Algiers to negotiate the ransom and release of English captives. He paid on average £30 per man (women were more expensive to ransom) and managed to free some 250 people before he ran out of money. Cason spent the last 8 years of his life trying to arrange the release of a further 400.

By the 1650s the attacks were so frequent that they threatened England's fishing industry with fishermen reluctant to put to sea, leaving their families unprotected ashore.

Oliver Cromwell decided to take action and decreed that any captured corsairs should be taken to Bristol and slowly drowned. Lundy Island, where pirates from the Republic of Salé had made their base, was attacked and bombarded, but despite this, the corsairs continued to mount raids on the coastal towns and villages in Cornwall, Devon and Dorset.

Those kidnapped would be sent to the slave markets of the Ottoman Empire to be

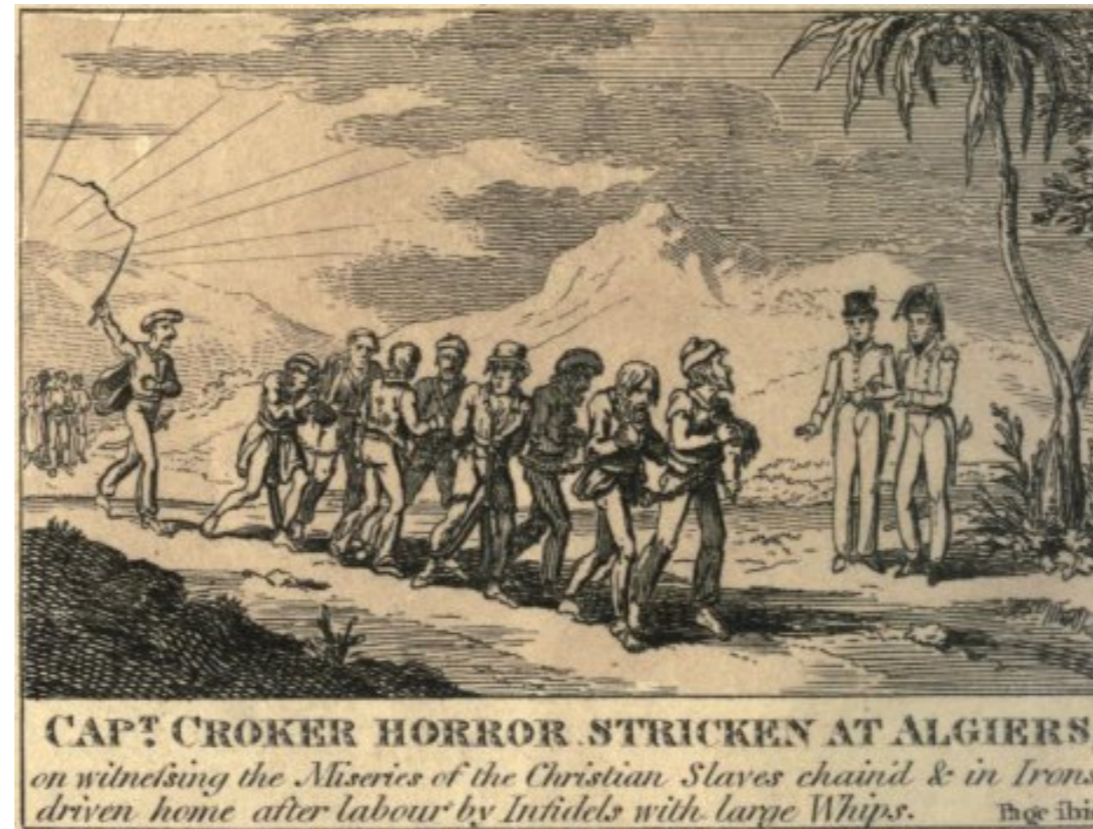

Barbary slaves

The Barbary slave trade even features in Samuel Pepys' diary, in an entry from 8th February 1661:

'...went to the Fleece Tavern to drink; and there we spent till four o'clock, telling stories of Algiers, and the manner of the life of slaves there! And truly Capt'n. Mootham and Mr. Dawes (who have been both slaves there) did make me fully acquainted with their condition there: as, how they eat nothing but bread and water. ... How they are beat upon the soles of their feet and bellies at the liberty of their padron. How they are all, at night, called into their master's Bagnard; and there they lie. How the poorest men do use their slaves best. How some rogues do live well, if they do invent to bring their masters in so much a week by their industry or theft; and then they are put to no other work at all. And theft there is counted no great crime at all...'

Something had to be done. In 1675 Sir John Narborough, backed by a Royal Navy squadron, managed to negotiate a peace with Tunis. A heavy naval bombardment by the British then brought about a similar peace with Tripoli. Algiers was also attacked from the sea, not only by British warships but also by the French and Spanish. The United States fought two wars against the Barbary States of North Africa: the First Barbary War of 1801–1805 and the Second Barbary War, 1815 – 1816. Finally after an attack by the British and Dutch in 1816 more than 4,000 Christian slaves were liberated and the power of the Barbary pirates was broken.



William Wilberforce

On Friday July 26th 1833 as he lay on his deathbed Wilberforce exclaimed: "Thank God that I have lived to witness the day in which England is willing to give £20 million for the abolishment of slavery." (What would that be worth today?) He died three days later.

The Slavery Abolition Bill 1833 passed through the House of Lords, it received the Royal Assent (which means it became law) on 29 August 1833 and came into force on 1 August 1834. On that date slavery was abolished throughout the vast British Empire. The Act automatically applied as new possessions (principally in Africa) subsequently became part of the British Empire.

To know who rules over you. Simply find out who it is that you are not allowed to criticise.Voltaire

We, as White people, have been GAGGED!! Then bullied, insulted, demonised, and provoked, until we object and complain. We then get called *dirty names* like Nazi, Racist, White Extremist, etc, etc.

Our weak & corrupt Lib/Lab/Con Politicians are the problem. As of Jan 2021, the UK elections are years away. Check out Populism, and Nationalism ASAP. Become "WHITE WOKE" & Push Back.

Do it today, NOW!

Whites Were Slaves In North Africa

Paul Craig Roberts

From: <https://www.paulcraigroberts.org/2019/03/12/whites-were-slaves-in-north-africa-before-blacks-were-slaves-in-the-new-world/>

Things that used to be true before political correctness set in:

More whites were brought as slaves to North Africa than blacks brought as slaves to the United States

<http://www.hannenabintuherland.com/europe/larry-elder-more-whites-were-brought-as-slaves-to-north-africa-than-blacks-brought-as-slaves-to-the-united-states-herland-report/>

Before sending ignorant hate mail, consider these Wikipedia entries:

"The Barbary slave trade refers to the slave markets that were lucrative and vast on the Barbary Coast of North Africa, which included the Ottoman provinces of Algeria, Tunisia and Tripolitania and the independent sultanate of Morocco, between the 16th and middle of the 18th century. The Ottoman provinces in North Africa were nominally under Ottoman suzerainty, but in reality they were mostly autonomous. The North African slave markets were part of the Berber slave trade.

"Ohio State University history Professor Robert Davis describes the White Slave Trade as minimized by most modern historians in his book Christian Slaves, Muslim Masters: White Slavery in the Mediterranean, the Barbary Coast and Italy, 1500–1800. Davis estimates that 1 million to 1.25 million Europeans were enslaved in North Africa, from the beginning of the 16th century to the middle of the 18th, by slave traders from Tunis, Algiers, and Tripoli alone (these numbers do not include the European people who were enslaved by Morocco and by other raiders and traders of the Mediterranean Sea coast),[3] and roughly 700 Americans were held captive in this region as slaves between 1785 and 1815.[4]

"From bases on the Barbary coast, North Africa, the Barbary pirates raided ships traveling through the Mediterranean and along the northern and western coasts of Africa, plundering their cargo and enslaving the people they captured. From at least 1500, the pirates also conducted raids along seaside towns of Italy, Spain, France, England, the Netherlands and as far away as Iceland, capturing men, women and children. On some occasions, settlements such as Baltimore, Ireland were abandoned following the raid, only being resettled many years later. Between 1609 and 1616, England alone had 466 merchant ships lost to Barbary pirates.[8]

"While Barbary corsairs looted the cargo of ships they captured, their primary goal was to capture non-Muslim people for sale as slaves or for ransom. Those who had family or friends who might ransom them were held captive, the most famous of these was the author Miguel de Cervantes, who was held for almost five years. Others were sold into various types of servitude. Captives who converted to Islam were generally freed, since enslavement of Muslims was prohibited; but this meant that they could never return to their native countries.[9][10]

"Sixteenth- and 17th-century customs statistics suggest that Istanbul's additional slave import from the Black Sea may have totaled around 2.5 million from 1450 to 1700.[11] The markets declined after the loss of the Barbary Wars and finally ended in the 1800s, after a US Navy expedition under Commodore Edward Preble engaging gunboats and fortifications in Tripoli, 1804 and later when after a British diplomatic mission led to some confused orders and a massacre; British and Dutch ships delivered a punishing nine-hour bombardment of Algiers leading to an acceptance of terms. It ended with the French conquest of Algeria (1830-1847).

"Perpetrated largely on Europeans, and within in-land routes to indigenous European inhabitants. These peoples were systematically preyed upon and turned into slaves, acquired by Barbary pirates during slave raids on ships and by raids on coastal towns from Italy to the Netherlands, as far north as Iceland and in the eastern shores of the Mediterranean."

https://en.wikipedia.org/wiki/Barbary_slave_trade

"White slavery, white slave trade, and white slave traffic refer to the chattel slavery of White Europeans by non-Europeans (such as North Africans and the Muslim world), as well as by Europeans themselves, such as the Viking thralls or European Galley slaves. From Antiquity, European slaves were common during the reign of Ancient Rome and were prominent during the Ottoman Empire into the early modern period. In Feudalism, there were various forms of status below the Freeman that is known as Serfdom (such as the bordar, villein, vagabond and slave) which could be bought and sold as property and were subject to labor and branding by their owners or demense. Under Muslim rule, the Arab slave trades that included Caucasian captives were often fueled by raids into European territories or were taken as children in the form of a blood tax from the families of citizens of conquered territories to serve the empire for a variety of functions. In the mid-19th century, the term 'white slavery' was used to describe the Christian slaves that were sold into the Barbary slave trade."

https://en.wikipedia.org/wiki/White_slavery

See also:

March 7, 2004

When Europeans Were Slaves: Research Suggests White Slavery Was Much More Common Than Previously Believed

COLUMBUS, Ohio – A new study suggests that a million or more European Christians were enslaved by Muslims in North Africa between 1530 and 1780 – a far greater number than had ever been estimated before.

Home  Index



William Wilberforce

On Friday July 26th 1833 as he lay on his deathbed Wilberforce exclaimed: "Thank God that I have lived to witness the day in which England is willing to give £20 million for the abolishment of slavery." (What would that be worth today ?) He died three days later.

The Slavery Abolition Bill 1833 passed through the House of Lords, it received the Royal Assent (which means it became law) on 29 August 1833 and came into force on 1 August 1834. On that date slavery was abolished throughout the vast British Empire. The Act automatically applied as new possessions (principally in Africa) subsequently became part of the British Empire.

To know who rules over you. Simply find out who it is that you are not allowed to criticise.Voltaire

We, as White people, have been GAGGED!! Then bullied, insulted, demonised, and provoked, until we object and complain. We then get called *dirty names* like Nazi, Racist, White Extremist, etc, etc.

Our weak & corrupt Lib/Lab/Con Politicians are the problem. As of Jan 2021, the UK elections are years away. Check out Populism, and Nationalism ASAP. Become "WHITE WOKE" & Push Back.

Do it today, NOW!



William Wilberforce

On Friday July 26th 1833 as he lay on his deathbed Wilberforce exclaimed: "Thank God that I have lived to witness the day in which England is willing to give £20 million for the abolishment of slavery." (What would that be worth today ?)

He died three days later.

The Slavery Abolition Bill 1833 passed through the House of Lords, it received the Royal Assent (which means it became law) on 29 August 1833 and came into force on 1 August 1834.

On that date slavery was abolished throughout the vast British Empire.

The Act automatically applied as new possessions (principally in Africa) subsequently became part of the British Empire.

To know who rules over you. Simply find out who it is that you are not allowed to criticise.

.....Voltaire

We, as White people, have been GAGGED!! Then bullied, insulted, demonised, and provoked, until we object and complain. We then get called *dirty names* like Nazi, Racist, White Extremist, etc, etc.

Our weak & corrupt Lib/Lab/Con Politicians are the problem. As of Jan 2021, the UK elections are years away. Check out Populism, and Nationalism ASAP. Become "WHITE WOKE" & Push Back.

Do it today, NOW!

In a new book, Robert Davis, professor of history at Ohio State University, developed a unique methodology to calculate the number of white Christians who were enslaved along Africa's Barbary Coast, arriving at much higher slave population estimates than any previous studies had found.

Most other accounts of slavery along the Barbary coast didn't try to estimate the number of slaves, or only looked at the number of slaves in particular cities, Davis said. Most previously estimated slave counts have thus tended to be in the thousands, or at most in the tens of thousands. Davis, by contrast, has calculated that between 1 million and 1.25 million European Christians were captured and forced to work in North Africa from the 16th to 18th centuries.

Davis's new estimates appear in the book *Christian Slaves, Muslim Masters: White Slavery in the Mediterranean, the Barbary Coast, and Italy, 1500-1800* (Palgrave Macmillan).

"Enslavement was a very real possibility for anyone who traveled in the Mediterranean, or who lived along the shores in places like Italy, France, Spain and Portugal, and even as far north as England and Iceland."

"Much of what has been written gives the impression that there were not many slaves and minimizes the impact that slavery had on Europe," Davis said. "Most accounts only look at slavery in one place, or only for a short period of time. But when you take a broader, longer view, the massive scope of this slavery and its powerful impact become clear."

Davis said it is useful to compare this Mediterranean slavery to the Atlantic slave trade that brought black Africans to the Americas. Over the course of four centuries, the Atlantic slave trade was much larger – about 10 to 12 million black Africans were brought to the Americas. But from 1500 to 1650, when trans-Atlantic slaving was still in its infancy, more white Christian slaves were probably taken to Barbary than black African slaves to the Americas, according to Davis.

"One of the things that both the public and many scholars have tended to take as given is that slavery was always racial in nature – that only blacks have been slaves. But that is not true," Davis said. "We cannot think of slavery as something that only white people did to black people."

During the time period Davis studied, it was religion and ethnicity, as much as race, that determined who became slaves.

"Enslavement was a very real possibility for anyone who traveled in the Mediterranean, or who lived along the shores in places like Italy, France, Spain and Portugal, and even as far north as England and Iceland," he said.

Pirates (called corsairs) from cities along the Barbary Coast in north Africa – cities such as Tunis and Algiers – would raid ships in the Mediterranean and Atlantic, as well as seaside villages to capture men, women and children. The impact of these attacks were devastating – France, England, and Spain each lost thousands of ships, and long stretches of the Spanish and Italian coasts were almost completely abandoned by their inhabitants. At its peak, the destruction and depopulation of some areas probably exceeded what European slavers would later inflict on the African interior.

Although hundreds of thousands of Christian slaves were taken from

Mediterranean countries, Davis noted, the effects of Muslim slave raids was felt much further away: it appears, for example, that through most of the 17th century the English lost at least 400 sailors a year to the slavers.

Even Americans were not immune. For example, one American slave reported that 130 other American seamen had been enslaved by the Algerians in the Mediterranean and Atlantic just between 1785 and 1793.

Davis said the vast scope of slavery in North Africa has been ignored and minimized, in large part because it is on no one's agenda to discuss what happened.

The enslavement of Europeans doesn't fit the general theme of European world conquest and colonialism that is central to scholarship on the early modern era, he said. Many of the countries that were victims of slavery, such as France and Spain, would later conquer and colonize the areas of North Africa where their citizens were once held as slaves. Maybe because of this history, Western scholars have thought of the Europeans primarily as "evil colonialists" and not as the victims they sometimes were, Davis said.

Davis said another reason that Mediterranean slavery has been ignored or minimized has been that there have not been good estimates of the total number of people enslaved. People of the time – both Europeans and the Barbary Coast slave owners – did not keep detailed, trustworthy records of the number of slaves. In contrast, there are extensive records that document the number of Africans brought to the Americas as slaves.

So Davis developed a new methodology to come up with reasonable estimates of the number of slaves along the Barbary Coast. Davis found the best records available indicating how many slaves were at a particular location at a single time. He then estimated how many new slaves it would take to replace slaves as they died, escaped or were ransomed.

"The only way I could come up with hard numbers is to turn the whole problem upside down – figure out how many slaves they would have to capture to maintain a certain level," he said. "It is not the best way to make population estimates, but it is the only way with the limited records available."

Putting together such sources of attrition as deaths, escapes, ransomings, and conversions, Davis calculated that about one-fourth of slaves had to be replaced each year to keep the slave population stable, as it apparently was between 1580 and 1680. That meant about 8,500 new slaves had to be captured each year. Overall, this suggests nearly a million slaves would have been taken captive during this period. Using the same methodology, Davis has estimated as many as 475,000 additional slaves were taken in the previous and following centuries.

The result is that between 1530 and 1780 there were almost certainly 1 million and quite possibly as many as 1.25 million white, European Christians enslaved by the Muslims of the Barbary Coast.

Davis said his research into the treatment of these slaves suggests that, for most of them, their lives were every bit as difficult as that of slaves in America.

"As far as daily living conditions, the Mediterranean slaves certainly didn't have it better," he said.



William Wilberforce

On Friday July 26th 1833 as he lay on his deathbed Wilberforce exclaimed: "Thank God that I have lived to witness the day in which England is willing to give £20 million for the abolishment of slavery." (What would that be worth today ?)

He died three days later.

The Slavery Abolition Bill 1833 passed through the House of Lords, it received the Royal Assent (which means it became law) on 29 August 1833 and came into force on 1 August 1834.

On that date slavery was abolished throughout the vast British Empire.

The Act automatically applied as new possessions (principally in Africa) subsequently became part of the British Empire.

To know who rules over you. Simply find out who it is that you are not allowed to criticise.Voltaire

We, as White people, have been GAGGED!! Then bullied, insulted, demonised, and provoked, until we object and complain. We then get called *dirty names* like Nazi, Racist, White Extremist, etc, etc.

Our weak & corrupt Lib/Lab/Con Politicians are the problem. As of Jan 2021, the UK elections are years away. Check out Populism, and Nationalism ASAP. Become "WHITE WOKE" & Push Back.

Do it today, NOW!

trading had been a very traditional Jewish occupation in much of Europe and the Middle East for the last thousand years, and it is probably more than coincidence that the largest centers of Jewish settlement in Colonial America tended to be those cities focused on the slave trade." <http://www.unz.com/runz/american-pravda-amazon-book-censorship/>

It is often overlooked that slaves were enslaved before they were bought and sold by Jews, Arabs, and Gentiles. The unasked question is: Who enslaved them?

The African slave trade originated in the black Kingdom of Dahomey in Africa. The black king of Dahomey conducted slave wars against rival black tribes. Arabs and later Europeans seeking a work force for the New World purchased black slaves from the black Kingdom of Dahomey. See Karl Polanyi, Dahomey and the Slave Trade. This important history is almost unobtainable in the present era of political correctness and fake history that has been created in order to manufacture a new victim group. American blacks learned from Jews that to obtain the status of victim group brings special privileges. Thus does truth fall to self-serving agendas. The protection of "holocaust" now extends to blacks, women, homosexuals, and transgendered.

While African slaves did grueling labor on sugar and cotton plantations in the Americas, European Christian slaves were often worked just as hard and as lethally – in quarries, in heavy construction, and above all rowing the corsair galleys themselves.

Davis said his findings suggest that this invisible slavery of European Christians deserves more attention from scholars.

"We have lost the sense of how large enslavement could loom for those who lived around the Mediterranean and the threat they were under," he said. "Slaves were still slaves, whether they are black or white, and whether they suffered in America or North Africa."

<https://news.osu.edu/when-europeans-were-slaves-research-suggests-white-slavery-was-much-more-common-than-previously-believed/>

See Also: White Cargo by Don Jordan and Michael Walsh, New York University Press, 2007. https://www.amazon.com/White-Cargo-Forgotten-History-Britains/dp/0814742963/ref=sr_1_1?keywords=White+Cargo&qid=1552344270&s=books&sr=1-1

The New Color Line by Paul Craig Roberts and Lawrence Stratton points out that the 1964 Civil Rights Act explicitly prohibited racial quotas. Despite the statutory prohibition, Alfred W. Blumrosen, compliance chief and de facto head of the Equal Employment Opportunity Commission (EEOC) imposed quotas on his bet that the EEOC's "interpretation" of the law would be upheld by the federal courts out of deference to the regulatory commission. Blumrosen won his bet, and the Civil Rights Act was stood on its head. Blumrosen's imposition of racial quotas is a perfect example of how regulators, not legislators, write our laws. https://www.amazon.com/New-Color-Line-Paul-Roberts/dp/0895264625/ref=sr_1_1?keywords=The+New+Color+Line&qid=1552343014&s=books&sr=1-1

In his report on Amazon.com's censoring of politically incorrect books by Jewish and Black authors for telling the truth, Ron Unz notes that contrary to the fake history that puts the blame for black slavery on white gentiles, Jews themselves played a prominent role in the black slave trade:

"For more than a half-century, Jewish political activists and engaged academics have pilloried white American society for its longstanding mistreatment of blacks, especially focusing upon the "original sin" of black slavery, and almost every morning my New York Times carries one or more articles filled with such denunciations. Americans of Anglo-Saxon founding stock are invariably portrayed as the villains of the story, with American Jews frequently cited as among the heroic supporters of the Civil Rights Movement that eventually rectified some of those injustices.

"Yet, the true facts may be somewhat more complex. Over a quarter-century ago, provocative NOI researchers published a fascinating volume gathering together a huge quantity of historical evidence suggesting that prior to the Civil War, America's tiny Jewish population had actually played an enormously disproportionate role in establishing and promoting black slavery, with their co-ethnics even sometimes outright dominating that institution in the vast and exceptionally cruel slave plantations of Latin America, which were frequently operated like death-camps. These claims are hardly implausible given that slave-

Barbary Slaves: White Slaves and North African Pirates

Remembering the Barbary Slaves: White Slaves and North African Pirates

From [Ancient Origins](#)



Map of Barbaria from the 17th century where a trade in white Barbary slaves was rampant.

Much attention and condemnation has been directed towards the tragedy of the African slave trade, which took place between the 16th and the 19th centuries. However, another equally despicable trade in Barbary slaves was taking place around the same time in the Mediterranean. It is estimated that up to 1.25 million Europeans were enslaved by Barbary corsairs and their lives were just as pitiful as their African counterparts. They have come to be known as the white slaves of Barbary.

Slavery is one of the oldest trades known to man. We can first find records of the slave trade dating back to the Code of Hammurabi in Babylon in the 18th century



BC. People from virtually every major culture, civilization, and religious background have made slaves of their own and enslaved other peoples. However, comparatively little attention has been given to the prolific trade in Barbary slaves that was carried out by pirates, or corsairs, along the Barbary coast (as it was called by Europeans at the time), in what is now Morocco, Algeria, Tunisia, and Libya. Keep in mind that beginning around 1600 AD, anyone travelling in the Mediterranean faced the real prospect of being captured by the corsairs, taken to Barbary Coast cities and being sold as a slave.

The Sacking of Baltimore: Barbary Slaves from Ireland

Not content with attacking ships and sailors, the corsairs also sometimes raided coastal settlements in Italy, France, Spain, Portugal, England, Ireland, and even as far away as the Netherlands and Iceland. They landed on unguarded beaches, creeping up on villages in the dark to capture their victims.

Almost all the inhabitants of the village of Baltimore, in Ireland, were taken in this way in 1631. As a result of this threat, numerous coastal towns in the Mediterranean were almost completely abandoned by their inhabitants until the 19th century.

The raiding of the coastal village of Baltimore on Ireland's southwest coast is one of the more horrific acts performed by the Barbary corsairs. At 2.00 a.m. on June 20, 1631, over 200 corsairs armed with muskets, iron bars, and sticks of burning wood landed on the shore of Baltimore and silently spread out, waiting at the front doors of the cottages along the shoreline and the homes in the main village. When a signal was given, they simultaneously charged into the homes, pulling the sleeping inhabitants from their beds. Men, women and children, 107 in all, were dragged onto ships and began the long voyage back to Algiers.



William Wilberforce

On Friday July 26th 1833 as he lay on his deathbed Wilberforce exclaimed: "Thank God that I have lived to witness the day in which England is willing to give £20 million for the abolishment of slavery." (What would that be worth today?) He died three days later.

The Slavery Abolition Bill 1833 passed through the House of Lords, it received the Royal Assent (which means it became law) on 29 August 1833 and came into force on 1 August 1834. On that date slavery was abolished throughout the vast British Empire.

The Act automatically applied as new possessions (principally in Africa) subsequently became part of the British Empire.

To know who rules over you. Simply find out who it is that you are not allowed to criticise.Voltaire

We, as White people, have been GAGGED!! Then bullied, insulted, demonised, and provoked, until we object and complain. We then get called *dirty names* like Nazi, Racist, White Extremist, etc, etc.

Our weak & corrupt Lib/Lab/Con Politicians are the problem. As of Jan 2021, the UK elections are years away. Check out Populism, and Nationalism ASAP. Become "WHITE WOKE" & Push Back.

Do it today, NOW!

Upon arrival, the citizens of Baltimore were taken to slave pens before being paraded before prospective buyers, chained and nearly naked. Men were typically used for labor and women as concubines, while children were often raised as Muslims, eventually forming part of the slave corps within the Ottoman army.

The Rise of the Barbary Corsairs

In the 13th and 14th centuries, it was Christian pirates, primarily from Catalonia and Sicily, that dominated the seas, posing a constant threat to merchants. It was not until the expansion of the Ottoman Empire in the 15th century that the Barbary corsairs started to become a menace to Christian shipping. Around 1600 AD, European pirates brought advanced sailing and shipbuilding techniques to the Barbary Coast, which enabled the corsairs to extend their activities into the Atlantic Ocean, and the impact of Barbary raids peaked in the early to mid-17th century.

While the trade in Barbary slaves is typically portrayed as Muslim corsairs capturing white Christian victims, this is far too simplistic. In reality, the corsairs were not concerned with the race or religious orientation of those they captured. Slaves in Barbary could be black, brown, or white, Catholic, Protestant, Orthodox, Jewish, or Muslim. The corsairs, on the other hand, were not only Muslim. English privateers and Dutch captains also exploited the changing loyalties of an era in which friends could become enemies with the stroke of a pen.

"One of the things that both the public and many scholars have tended to take as given is that slavery was always racial in nature," said historian Robert Davis, author of ' Christian Slaves, Muslim Masters: White Slavery in the Mediterranean, the Barbary Coast, and Italy .' "But that is not true," he added. In comments which may stoke controversy, Davis claims that white slavery had been minimized or ignored because academics preferred to treat Europeans as evil colonialists rather than as victims.

Life as a Barbary Slave

The slaves captured by the Barbary pirates faced a grim future. Many died on the ships during the long voyage back to North Africa due to disease or lack of food and water. Those who survived were taken to slave markets where they would stand for hours while buyers inspected them before they were sold at auction.

After purchase, slaves would be put to work in various ways. Men were usually assigned to hard manual labor, such as working in quarries or heavy construction, while women were used for housework or in sexual servitude. At night the slaves were put into prisons called bagnios that were often hot and overcrowded.

However, by far the worst fate for a Barbary slave was being assigned to man the oars of galleys. Rowers were shackled where they sat, and never allowed to leave.

Sleeping, eating, defecating and urinating took place at the seat. Overseers would crack the whip over the bare backs of any slaves considered not to be working hard enough.

The End of the Barbary Corsairs

Corsair activity began to diminish in the latter part of the 17th century, as the more powerful European navies started to force the pirates to cease attacking their shipping. However, it wasn't until the first years of the 19th century that the United States of America and some European nations began to fight back more fervently against the Barbary pirates.

In the early 19th century Algiers was frequently bombarded by the French, Spanish and Americans. Eventually, after an Anglo-Dutch raid in 1816 on Algiers, the corsairs were forced to agree to terms which included a cessation of the practice of enslaving Christians, although slave trading of non-Europeans was allowed to continue.

Occasional incidents continued to occur until another British raid on Algiers in 1824, and finally a French invasion of Algiers in 1830, which placed it under colonial rule. Tunis was similarly invaded by France in 1881. Tripoli returned to direct Ottoman control in 1835, before finally falling into Italian hands in the 1911 Italo-Turkish War. The slave trade finally ceased on the Barbary coast when European governments passed laws granting emancipation to slaves.



William Wilberforce

On Friday July 26th 1833 as he lay on his deathbed Wilberforce exclaimed: "Thank God that I have lived to witness the day in which England is willing to give £20 million for the abolishment of slavery." (What would that be worth today ?) He died three days later.

The Slavery Abolition Bill 1833 passed through the House of Lords, it received the Royal Assent (which means it became law) on 29 August 1833 and came into force on 1 August 1834. On that date slavery was abolished throughout the vast British Empire. The Act automatically applied as new possessions (principally in Africa) subsequently became part of the British Empire.

To know who rules over you. Simply find out who it is that you are not allowed to criticise.Voltaire

We, as White people, have been GAGGED!! Then bullied, insulted, demonised, and provoked, until we object and complain. We then get called *dirty names* like Nazi, Racist, White Extremist, etc, etc.

Our weak & corrupt Lib/Lab/Con Politicians are the problem. As of Jan 2021, the UK elections are years away. Check out Populism, and Nationalism ASAP. Become "WHITE WOKE" & Push Back.

Do it today, NOW!

Jews And The White Slave Trade

Jewish slave dealers followed Caesar's armies everywhere -- into Gaul, into Germany, and into other northern lands.

From <https://nationalvanguard.org>

Steven Spielberg's pseudo-historical film about a 19th-century mutiny and massacre aboard a Spanish slave ship, Amistad, and the subsequent trial of the Black mutineers is being praised by the reviewers. Spielberg, one of the wealthiest and most successful of Hollywood's Jewish film makers, is also being praised by his kinsmen in various so-called "human rights" organizations for using his propaganda skills to sensitize White, Gentile audiences to the horrors of slavery and make them feel just a little more guilty for treating non-Whites so badly in the past. What the film doesn't mention, of course, is that Spielberg's Jewish kinsmen owned many, though not all, of the ships involved in the 18th- and 19th-century Atlantic trade in Black slaves and, in fact, played a very prominent role in bringing Black slaves to America.

The film tends to steer one away from blaming anyone for slavery except White Gentiles. This bit of misdirection is interesting in light of the fact that Jews have been dominant in the slave trade since at least Roman times -- especially the trade in White slaves. Jewish slave dealers followed Caesar's armies everywhere -- into Gaul, into Germany, and into other northern lands -- eager to buy as slaves all of the captives of the Romans -- especially the female captives.

Jews have remained dominant in the White slave trade until the present day -- although during the Middle Ages the Christian Church tried unsuccessfully a number of times to stop them, beginning in the fifth century with an edict by the emperor Theodosius II against Jews owning Christian slaves. After being banned from owning or dealing in slaves by one emperor, the Jews would wait until the next emperor came along, then they would buy a charter giving them a monopoly in the slave trade. Then public outrage against the Jews would grow until another emperor would ban their slave-dealing again. Most of the time, however, the Jews were the undisputed masters of the White slave trade, and that is still the case today.

Interestingly enough, this fact was revealed in a recent news report in the Jewish newspaper the New York Times, of all places.

The January 11 issue has a major article titled "Contraband Women" and written by a Jewish reporter in Israel.

The article deals specifically with the Jewish trade in Ukrainian and Russian women -- although it doesn't label the trade as "Jewish." What the report does say is this:

Centered in Moscow and the Ukrainian capital Kiev, the networks trafficking women run east to Japan and Thailand, where thousands of young Slavic women now work against their will as prostitutes, and west to the Adriatic coast and

"You must understand, the leading Bolsheviks who took over Russia were not Russians. They hated Russians. They hated Christians. Driven by ethnic hatred they tortured and slaughtered millions of Russians without a shred of human remorse.

It cannot be overstated. Bolshevism committed the greatest human slaughter of all time. The fact that most of the world is ignorant and uncaring about this enormous crime is proof that the global media is in the hands of the perpetrators."

- Aleksandr Solzhenitsyn

Marxist Generals - Ethnic Soldiers - White Victims - Worldwide



organized crime in many areas of America -- especially the East Coast and Los Angeles -- by "Russian gangs" and of the viciousness and cleverness of these "Russian" gangsters, but there is never any mention of the fact that they are not Russians at all, but Jews from the former Soviet Union: Jews like Mr. Clinton's supporter Vadim Rabinovich, photographed shaking hands with Clinton at a Miami fundraiser when he was illegally in the United States, as I mentioned in my broadcast of December 27, 1997.

The story of the exploitation of eastern Europe by the Jews is a fascinating and infuriating story. Throughout the Middle Ages and into the modern era they focused on profiting from the weaknesses and vices of the Gentile populations of Poles, Russians, Ukrainians and others among whom they lived as a barely tolerated minority. In addition to being the moneylenders, they controlled the liquor business and owned the drinking establishments, the gambling dens, and the brothels. A number of 19th-century Russian writers, among them Dostoevski



William Wilberforce

On Friday July 26th 1833 as he lay on his deathbed Wilberforce exclaimed: "Thank God that I have lived to witness the day in which England is willing to give £20 million for the abolishment of slavery." (What would that be worth today?)

He died three days later.

The Slavery Abolition Bill 1833 passed through the House of Lords, it received the Royal Assent (which means it became law) on 29 August 1833 and came into force on 1 August 1834.

On that date slavery was abolished throughout the vast British Empire.

The Act automatically applied as new possessions (principally in Africa) subsequently became part of the British Empire.

To know who rules over you. Simply find out who it is that you are not allowed to criticise.Voltaire

We, as White people, have been GAGGED!! Then bullied, insulted, demonised, and provoked, until we object and complain. We then get called *dirty names* like Nazi, Racist, White Extremist, etc, etc.

Our weak & corrupt Lib/Lab/Con Politicians are the problem. As of Jan 2021, the UK elections are years away. Check out Populism, and Nationalism ASAP. Become "WHITE WOKE" & Push Back.

Do it today, NOW!

and Gogol, have described their destructive effects on Slavic peasant society and the perpetual condition of mutual hostility which existed between the Jews and the Slavs.

During the 19th and early 20th centuries the Jewish trade in White slaves from these lands expanded enormously. It has been described by the Jewish historian Edward Bristow in his 1982 book *Prostitution and Prejudice*, published by Oxford University Press and Schocken Books in New York. Although Bristow's book is written from the viewpoint of one opposed to this Jewish trade in women, it is nevertheless enormously revealing. The Jews recruited peasant girls in Polish and Russian villages, usually under false pretenses, and transported them to brothels in Turkey, Egypt, and other parts of the Middle East; to Vienna, Budapest, and other major cities in the Austro-Hungarian Empire; and as far away as New York, New Orleans, and Buenos Aires. This Jewish trade in Slavic women naturally caused a great deal of hatred against the Jews by the Slavs, and this hatred broke out in pogroms and other popular actions against the Jews over and over again.

One would believe from the works of Mr. Spielberg and other Jewish propagandists that the hatred the Slavs bore against the Jews was based only on religious bigotry and that the Jews were completely innocent and inoffensive.

One fascinating fact which Bristow's book reveals is that the center of the Jewish trade in Polish girls was in a little town called Oswiecim. The German name for this town was Auschwitz.

I don't mean to imply that the Jews were the only ones at fault in the White slave trade. Gentile politicians and police officials gladly accepted bribes from the Jews and in return allowed them to carry on their dirty business. And in the United States non-Jewish criminal elements such as the Mafia collaborated with the Jews or ran their own White slave operations. But the trade in White slaves from eastern Europe has been an exclusively Jewish activity for the last 200 years.

It is ironic that another Jewish enterprise, organized Marxism, put a temporary crimp in the Jewish trade in Slavic women. When the Jewish Bolsheviks seized control of Russia and Ukraine after the First World War, and of Poland and other Slavic lands after the Second World War, they clamped down on all capitalist activity, including that of their Jewish brethren in the White slave business. What they did instead was establish a huge empire of slave-labor camps, of which Alexander Solzhenitsyn has written so eloquently. Jewish slave dealers became commissars and slave camp bosses. And of course, they butchered their Gentile opponents by the millions. The time of communism was the Jews' time for getting rid of all of the Russian and Ukrainian patriots, who had hated them for so long.

Actually, some capitalist activity did survive throughout the communist years in the form of organized crime. Two excellent books on the subject were published in the United States, both written by Soviet Jews thoroughly familiar with organized crime in the Soviet Union. In fact, one of the authors, Yuri Brokhin, was a former member of a Jewish organized crime gang in Russia, where he worked as a pimp. His book, *Hustling on Gorky Street*, was published in 1975 by Dial Press.

The other author, Konstantin Simis, was a Jewish defense lawyer for organized Jewish criminals. His book, *USSR: The Corrupt Society*, was published in 1982 by Simon and Schuster. Both of these Jewish authors write quite frankly about the Jewish domination of organized crime during the communist years. Brokhin brags

about it, in fact. He says Russians and other Slavs can only be ordinary criminals, depending on guns and strong-arm tactics, but they aren't smart enough for successful, large-scale organized crime; only Jews are smart enough for that.

A factor neither author mentions which was more important than smartness was the connections Jewish criminals had with Jewish communists in the Soviet bureaucracy. When Abe, who ran a prostitution and drug racket in Moscow, could count on his cousin Hymie in the prosecutor's office to keep him informed about police plans for raids, as well as a little covert assistance if matters ever came to court, he had a distinct advantage over his Russian competitors.

Eventually communism bled eastern Europe dry, and with the economies of the countries under their control on the verge of collapse the communists switched hats, declared themselves "democrats" instead of communists, and announced a return to capitalism. The Jewish slave dealers went back into business, and business was good for them. Other Jewish communists went into business too. As the economies were "privatized" -- that is, as state-owned factories and businesses were sold to private entrepreneurs at bargain-basement prices -- Jews used their connections with their now-"democratic" kinsmen in the bureaucracies to snap them up. Other Jews, who had monopolized organized crime during the communist years, remained as organized crime bosses but greatly expanded the scope of their operations. Often, the new entrepreneurs and the new crime bosses are the same people.

The richest man in Russia today is Boris Berezovsky, who since the collapse of communism has become a multi-billionaire by buying up banks, television networks, and newspapers from the government, with the aid of his fellow Jews still in the bureaucracy. Berezovsky speeds around Moscow in a bulletproof vest and an armored limousine, and anyone who gets in the way of his business interests has a tendency to get shot or simply to disappear.

Second only to Berezovsky in wealth is another Jewish media mogul, Vladimir Gusinsky. Between them, Berezovsky and Gusinsky control most of the mass media in Russia. They also exercise pretty thorough control of Boris Yeltsin, Russia's alcoholic president, who is sort of a Slavic version of Bill Clinton, plus vodka. It was only through the support of Berezovsky's and Gusinsky's media that Yeltsin won his last election.

If you remember, Clinton and all of the Jewish media in the United States also were rooting enthusiastically for Yeltsin during that election. They all were afraid that a genuine Russian patriot might beat Yeltsin, in which case the Jewish control of Russia would have been finished.

After the election, Yeltsin appointed Berezovsky to Russia's national security council, but when some of the few media in Russia which still are independent publicized Berezovsky's connections to Jewish organized crime gangs, Yeltsin was forced to fire him. Yeltsin has made up for that, however, by appointing another Jew, Boris Nemtsov, to the position of deputy prime minister, one of the most powerful positions in the government.

One thing Yeltsin never has done, however, is make any move to curtail the operations of Russia's organized Jewish crime gangs, which are running rampant



William Wilberforce

On Friday July 26th 1833 as he lay on his deathbed Wilberforce exclaimed: "Thank God that I have lived to witness the day in which England is willing to give £20 million for the abolishment of slavery." (What would that be worth today ?) He died three days later.

The Slavery Abolition Bill 1833 passed through the House of Lords, it received the Royal Assent (which means it became law) on 29 August 1833 and came into force on 1 August 1834. On that date slavery was abolished throughout the vast British Empire. The Act automatically applied as new possessions (principally in Africa) subsequently became part of the British Empire.

To know who rules over you. Simply find out who it is that you are not allowed to criticise.Voltaire

We, as White people, have been GAGGED!! Then bullied, insulted, demonised, and provoked, until we object and complain. We then get called *dirty names* like Nazi, Racist, White Extremist, etc, etc.

Our weak & corrupt Lib/Lab/Con Politicians are the problem. As of Jan 2021, the UK elections are years away. Check out Populism, and Nationalism ASAP. Become "WHITE WOKE" & Push Back.

Do it today, NOW!

through the country and displaying their wealth and power, while ordinary Russians struggle to feed themselves and keep their homes warm this winter.

And tens of thousands of pretty but naive young Russian and Ukrainian women are being swept up by the Jewish gangs -- called "Russian" gangs by the New York Times -- and shipped off to a life of misery and degradation in Turkey, Pakistan, Thailand, and Israel, as well as to countries in western Europe, where Jews also control organized crime. The young women, unable to find work in Russia, Ukraine, or Poland and facing a bleak future in countries ravaged by decades of communism, are eager for any chance at a better life. They respond to advertisements that offer them work abroad as receptionists or secretaries and also promise free training and transportation. When the girls arrive at their destinations, however, they find something quite different -- but by then it is too late.

One of these girls, Irina, a 21-year-old, green-eyed Ukrainian blond, was interviewed in Israel. She told how her Israeli employer took her to a brothel soon after her arrival in Israel. He took her passport away from her, burned it before her eyes, and told her that she now was his property and must work in the brothel. When Irina refused, she was beaten and raped. Luckier than most of the Slavic women lured to Israel, Irina eventually was swept up in a police raid and sent to prison as an illegal alien. She was awaiting deportation, along with hundreds of other Russian and Ukrainian women, when she was interviewed. She lamented the fact that the Israeli who had raped her and forced her to work in the brothel was not even arrested. Indeed, according to Jewish law, the rape of a Gentile woman is not illegal. Nor is it illegal in Israel to buy and sell slaves, so long as the slaves are not Jewish. Amazingly, the New York Times article reveals this fact.

The White slave trade is big business in Israel. Ukrainian authorities estimate that as many as 40,000 Ukrainian women under the age of 30 are taken from Ukraine each year. Some of these women respond to advertisements promising employment abroad, like Irina did, and some are simply kidnapped and smuggled out of the country. Those who try to escape from their Jewish captors are treated brutally. Often they are butchered in front of other captive women to keep the others terrified into doing whatever they are told. At slave markets operated by the Jewish gangs in Italy young Slavic women are stripped, put on blocks, and auctioned off to brothel owners.

The most astounding thing about this whole, filthy business is that most people are forced to learn about it from a Jewish newspaper like the New York Times. And really, you should read for yourself the article to which I referred. It was in the January 11, 1998, issue, and the news is not likely to be repeated.

Ask yourself, why doesn't Interpol, the international police agency, do something to put a stop to this White slave trade? Why don't the governments of the countries from which the women are being abducted do something? Why don't the mass media raise a hue and cry? Why don't powerful feminist organizations demand the eradication of White slavery?

And the answer to all of these questions is easy: they dare not do or say anything because it is a Jewish business. In places like Germany, where the Jews have almost total control of organized crime, anyone who announces that fact publicly will be arrested and charged with "inciting racial hatred." Germany and most other

European countries have laws against what they call "hate speech." Saying anything negative about Jews, true or not, invokes these laws.

Jewish organizations -- and of course, the Clinton administration -- would like very much to have similar laws in the United States. Interpol, which has plenty of other work to keep it busy, is not eager to be charged with "anti-Semitism" by going after the Jewish White-slave gangs. Even if Interpol did arrest the gangsters, it wouldn't do much good, because the fix is in nearly everywhere. There's a huge amount of money made from selling women: enough money to pay off politicians, bureaucrats, judges, and policemen.

Jews like to say about the so-called "Holocaust" of the Second World War, "Never again." They like to talk about how it is necessary to stamp out anti-Semitism and pass laws against so-called "hate speech," so that there can never be another "Holocaust." But by their own behavior they guarantee that there will be.

While some Jews beat the drums for more reparations payments from Switzerland, Germany, France, and other countries they claim didn't treat them right or took some of their ill-gotten gold from them 55 or 60 years ago, other Jews are still bleeding countries like Poland, Ukraine, Russia, and the Baltic nations of money and of their young women. Countries which suffered for decades under the brutal rule of communist commissars are still being exploited by the same people, now calling themselves "democrats."

The Jews believe that with their deathgrip on the mass media nearly everywhere, with their puppets -- like Bill Clinton and Boris Yeltsin -- in positions of power in the East and in the West, with the enormous wealth they have at their disposal, and with so many Gentiles buffaloed by "Holocaust" propaganda of the sort cranked out by Steven Spielberg and a hundred others, they can keep getting away with their exploitation of us forever. But they are wrong. They themselves are building up the hatred and the resentment and the rage which will destroy them. It will destroy them all: the gang members, the media bosses, the "advisers" to Bill Clinton and Boris Yeltsin, the professional "Holocaust" wailers, the former commissars, and the rest, even those who are not currently involved in any of these activities.

They are guaranteeing that there will be another "Holocaust."
And this time it will be a real one.

Thanks for being with me again today -- and do find and read that article on the White slave trade in the January 11, 1998, New York Times.



William Wilberforce

On Friday July 26th 1833 as he lay on his deathbed Wilberforce exclaimed: "Thank God that I have lived to witness the day in which England is willing to give £20 million for the abolishment of slavery." (What would that be worth today ?)
He died three days later.

The Slavery Abolition Bill 1833 passed through the House of Lords, it received the Royal Assent (which means it became law) on 29 August 1833 and came into force on 1 August 1834. On that date slavery was abolished throughout the vast British Empire. The Act automatically applied as new possessions (principally in Africa) subsequently became part of the British Empire.

To know who rules over you. Simply find out who it is that you are not allowed to criticise.Voltaire

We, as White people, have been GAGGED!! Then bullied, insulted, demonised, and provoked, until we object and complain. We then get called *dirty names* like Nazi, Racist, White Extremist, etc, etc.

Our weak & corrupt Lib/Lab/Con Politicians are the problem. As of Jan 2021, the UK elections are years away. Check out Populism, and Nationalism ASAP. Become "WHITE WOKE" & Push Back.

Do it today, NOW!

Contraband Women

Naive Slavic Women In Israel

Contraband women a special report. Traffickers' new cargo: naive slavic women
january 11, 1998 RAMLE, Israel

From <http://www.michaelspecter.com>

Irina always assumed that her beauty would somehow rescue her from the poverty and hopelessness of village life. A few months ago, after answering a vague ad in a small Ukrainian newspaper, she slipped off a tour boat when it put in at Haifa, hoping to make a bundle dancing naked on the tops of tables. She was 21, self-assured and glad to be out of Ukraine. Israel offered a new world, and for a week or two everything seemed possible. Then, one morning, she was driven to a brothel, where her boss burned her passport before her eyes. "I own you," she recalled his saying. "You are my property and you will work until you earn your way out. Don't try to leave. You have no papers and you don't speak Hebrew. You will be arrested and deported.

Then we will get you and bring you back." It happens every single day. Not just in Israel, which has deported nearly 1,500 Russian and Ukrainian women like Irina in the past three years. But throughout the world, where selling naive and desperate young women into sexual bondage has become one of the fastest-growing criminal enterprises in the robust global economy. The international bazaar for women is hardly new, of course. Asians have been its basic commodity for decades. But economic hopelessness in the Slavic world has opened what experts call the most lucrative market of all to criminal gangs that have flourished since the fall of Communism: white women with little to sustain them but their dreams. Pimps, law enforcement officials and relief groups all agree that Ukrainian and Russian women are now the most valuable in the trade. Because their immigration is often illegal--and because some percentage of the women choose to work as prostitutes--statistics are difficult to assess.

But the United Nations estimates that four million people throughout the world are trafficked each year--forced through lies and coercion to work against their will in many types of servitude. The International Organization for Migration has said that as many as 500,000 women are annually trafficked into Western Europe alone. Many end up like Irina. Stunned and outraged by the sudden order to prostitute herself, she simply refused.

She was beaten and raped before she succumbed. Finally she got a break. The brothel was raided and she was brought here to Neve Tirtsa in Ramle, the only women's prison in Israel. Now, like hundreds of Ukrainian and Russian women with

no documents or obvious forgeries, she is waiting to be sent home. "I don't think the man who ruined my life will even be fined." she said softly, slow tears filling her enormous green eyes. "You can call me a fool for coming here. That's my crime. I am stupid.

A stupid girl from a little village. But can people really buy and sell women and get away with it? Sometimes I sit here and ask myself if that really happened to me, if it can really happen at all." Then, waving her arm toward the muddy prison yard, where Russian is spoken more commonly than Hebrew, she whispered one last thought: "I'm not the only one, you know. They have ruined us all." Traffic Patterns: Russia and Ukraine Supply the Flesh Centered in Moscow and the Ukrainian capital, Kiev, the networks trafficking women run east to Japan and Thailand, where thousands of young Slavic women now work against their will as prostitutes, and west to the Adriatic Coast and beyond. The routes are controlled by Russian crime gangs based in Moscow.

Even when they do not specifically move the women overseas, they provide security, logistical support, liaison with brothel owners in many countries and, usually, false documents. Women often start their hellish journey by choice.

Seeking a better life, they are lured by local advertisements for good jobs in foreign countries at wages they could never imagine at home. In Ukraine alone, the number of women who leave is staggering. As many as 400,000 women under 30 have gone in the past decade, according to their country's Interior Ministry. The Thai Embassy in Moscow, which processes visa applications from Russia and Ukraine, says it receives nearly 1,000 visa applications a day, most of these from women. Israel is a fairly typical destination. Prostitution is not illegal here, although brothels are, and with 250,000 foreign male workers--most of whom are single or here without their wives--the demand is great. Police officials estimate that there are 25,000 paid sexual transactions every day. Brothels are ubiquitous. None of the women seem to realize the risks they run until it is too late.

Once they cross the border their passports will be confiscated, their freedoms curtailed and what little money they have taken from them at once. "You want to tell these kids that if something seems too good to be true it usually is." said Lyudmilla Biryuk, a Ukrainian psychologist who has counseled women who have escaped or been released from bondage. "But you can't imagine what fear and real ignorance can do to a person." The women are smuggled by car, bus, boat and plane. Handed off in the dead of night, many are told they will pick oranges, work as dancers or as waitresses.

Others have decided to try their luck at prostitution, usually for what they assume will be a few lucrative months. They have no idea of the violence that awaits them. The efficient, economically brutal routine--whether here in Israel, or in one of a dozen other countries--rarely varies. Women are held in apartments, bars and makeshift brothels; there they service, by their own count, as many as 15 clients a day. Often they sleep in shifts, four to a bed. The best that most hope for is to be deported after the police finally catch up with their captors. Few ever testify.



William Wilberforce

On Friday July 26th 1833 as he lay on his deathbed Wilberforce exclaimed: "Thank God that I have lived to witness the day in which England is willing to give £20 million for the abolishment of slavery." (What would that be worth today ?)

He died three days later.

The Slavery Abolition Bill 1833 passed through the House of Lords, it received the Royal Assent (which means it became law) on 29 August 1833 and came into force on 1 August 1834. On that date slavery was abolished throughout the vast British Empire.

The Act automatically applied as new possessions (principally in Africa) subsequently became part of the British Empire.

To know who rules over you. Simply find out who it is that you are not allowed to criticise.Voltaire

We, as White people, have been GAGGED!! Then bullied, insulted, demonised, and provoked, until we object and complain. We then get called *dirty names* like Nazi, Racist, White Extremist, etc, etc.

Our weak & corrupt Lib/Lab/Con Politicians are the problem. As of Jan 2021, the UK elections are years away. Check out Populism, and Nationalism ASAP. Become "WHITE WOKE" & Push Back.

Do it today, NOW!



William Wilberforce

On Friday July 26th 1833 as he lay on his deathbed Wilberforce exclaimed: "Thank God that I have lived to witness the day in which England is willing to give £20 million for the abolishment of slavery." (What would that be worth today ?)

He died three days later.

The Slavery Abolition Bill 1833 passed through the House of Lords, it received the Royal Assent (which means it became law) on 29 August 1833 and came into force on 1 August 1834. On that date slavery was abolished throughout the vast British Empire.

The Act automatically applied as new possessions (principally in Africa) subsequently became part of the British Empire.

To know who rules over you.

Simply find out who it is that you are not allowed to criticise.

.....Voltaire

We, as White people, have been GAGGED!! Then bullied, insulted, demonised, and provoked, until we object and complain. We then get called *dirty names* like Nazi, Racist, White Extremist, etc, etc.

Our weak & corrupt Lib/Lab/Con Politicians are the problem. As of Jan 2021, the UK elections are years away. Check out Populism, and Nationalism ASAP. Become "WHITE WOKE" & Push Back.

Do it today, NOW!

Those who do risk death. Last year in Istanbul, Turkey, according to Ukrainian police investigators, two women were thrown to their deaths from a balcony while six of their Russian friends watched.

In Serbia, also last year, said a young Ukrainian woman who escaped in October, a woman who refused to work as a prostitute was beheaded in public. In Milan a week before Christmas, the police broke up a ring that was holding auctions in which women abducted from the countries of the former Soviet Union were put on blocks, partially naked, and sold at an average price of just under \$1,000. "This is happening wherever you look now." said Michael Platzer, the Vienna-based head of operations for the United Nations' Center for International Crime Prevention. "The mafia is not stupid. There is less law enforcement since the Soviet Union fell apart and more freedom of movement. The earnings are incredible. The overhead is low--you don't have to buy cars and guns. Drugs you sell once and they are gone. Women can earn money for a long time." "Also," he added, "the laws help the gangsters.

Prostitution is semilegal in many places and that makes enforcement tricky. In most cases punishment is very light." In some countries, Israel among them, there is not even a specific law against the sale of human beings. Mr. Platzer said that although certainly "tens of thousands" of women were sold into prostitution each year, he was uncomfortable with statistics since nobody involved has any reason to tell the truth. "But if you want to use numbers." he said, "think about this. Two hundred million people are victims of contemporary forms of slavery. Most aren't prostitutes, of course, but children in sweatshops, domestic workers, migrants. During four centuries, 12 million people were believed to be involved in the slave trade between Africa and the New World. The 200 million--and many of course are women who are trafficked for sex--is a current figure. It's happening now. Today." Distress Calls: Far-Flung Victims Provide Few Clues The distress call came from Donetsk, the bleak center of coal production in southern Ukraine. A woman was screaming on the telephone line. Her sister and a friend were prisoners in a bar somewhere near Rome. They spoke no Italian and had no way out, but had managed, briefly, to get hold of a man's cell phone. "Do you have any idea where they are, exactly?" asked Olga Shved, who runs La Strada in Kiev, Ukraine's new center dedicated to fighting the trafficking of women in Eastern Europe and the countries of the former Soviet Union.

The woman's answer was no. Ms. Shved began searching for files and telephone numbers of the local consul, the police, anybody who could help. "Do they know how far from Rome they are," she asked, her voice tightening with each word. "What about the name of the street or the bar? Anything will help," she said, jotting notes furiously as she spoke. "We can get the police on this, but we need something. If they call back, tell them to give us a clue. The street number. The number of a bus that runs past. One thing is all we need." Ms. Shved hung up and called officials at Ukraine's Interior Ministry and the Foreign Ministry. Her conversations were short, direct and obviously a routine part of her job. That is because Ukraine--and to a lesser degree its Slavic neighbors Russia and Belarus--has replaced Thailand and the Philippines as the epicenter of the global business in trafficking women. The Ukrainian problem has been worsened by a ravaged

economy, an atrophied system of law enforcement, and criminal gangs that grow more brazen each year. Young European women are in demand, and Ukraine, a country of 51 million people, has a seemingly endless supply. It is not that hard to see why. Neither Russia nor Ukraine reports accurate unemployment statistics. But even partial numbers present a clear story of chaos and economic dislocation. Federal employment statistics in Ukraine indicate that more than two-thirds of the unemployed are women. The Government also keeps another statistic: employed but not working. Those are people who technically have jobs, and can use company amenities like day-care centers and hospitals. But they do not work or get paid. Three-quarters are women. And of those who have lost their jobs since the Soviet Union dissolved in 1991, more than 80 percent are women. The average salary in Ukraine today is slightly less than \$30 a month, but it is half that in the small towns that criminal gangs favor for recruiting women to work abroad. On average, there are 30 applicants for every job in most Ukrainian cities. There is no real hope; but there is freedom. In that climate, looking for work in foreign countries has increasingly become a matter of survival. "It's no secret that the highest prices now go for the white women," said Marco Buffo, executive director of On the Road, an antitrafficking organization in northern Italy. "They are the novelty item now. It used to be Nigerians and Asians at the top of the market. Now it's the Ukrainians." Economics is not the only factor causing women to flee their homelands.

There is also social reality. For the first time, young women in Ukraine and Russia have the right, the ability and the willpower to walk away from their parents and their hometowns. Village life is disintegrating throughout much of the former Soviet world, and youngsters are grabbing any chance they can find to save themselves. "After the wall fell down, the Ukrainian people tried to live in the new circumstances," said Ms. Shved. "It was very hard, and it gets no easier. Girls now have few opportunities yet great freedom. They see 'Pretty Woman,' or a thousand movies and ads with the same point, that somebody who is rich can save them. The glory and ease of wealth is almost the basic point of the Western advertising that we see. Here the towns are dying. What jobs there are go to men. So they leave." First, however, they answer ads from employment agencies promising to find them work in a foreign country. Here again, Russian crime gangs play a central role. They often recruit people through seemingly innocuous "mail order bride" meetings. Even when they do not, few such organizations can operate without paying off one gang or another. Sometimes want ads are almost honest, suggesting that the women can earn up to \$1,000 a month as "escorts" abroad. Often they are vague or blatantly untrue. Recruiting Methods: Ads Make Offers Too Good to Be True One typical ad used by traffickers in Kiev last year read: "Girls: Must be single and very pretty.

Young and tall. We invite you for work as models, secretaries, dancers, choreographers, gymnasts. Housing is supplied. Foreign posts available. Must apply in person." One young woman who did, and made it back alive, described a harrowing journey. "I met with these guys and they asked if I would work at a strip bar." she said. "Why not, I thought. They said we would have to leave at once. We went by car to the Slovak Republic where they grabbed my passport. I think they



William Wilberforce

On Friday July 26th 1833 as he lay on his deathbed Wilberforce exclaimed: "Thank God that I have lived to witness the day in which England is willing to give £20 million for the abolishment of slavery." (What would that be worth today ?) He died three days later.

The Slavery Abolition Bill 1833 passed through the House of Lords, it received the Royal Assent (which means it became law) on 29 August 1833 and came into force on 1 August 1834. On that date slavery was abolished throughout the vast British Empire. The Act automatically applied as new possessions (principally in Africa) subsequently became part of the British Empire.

To know who rules over you. Simply find out who it is that you are not allowed to criticise.Voltaire

We, as White people, have been GAGGED!! Then bullied, insulted, demonised, and provoked, until we object and complain. We then get called *dirty names* like Nazi, Racist, White Extremist, etc, etc.

Our weak & corrupt Lib/Lab/Con Politicians are the problem. As of Jan 2021, the UK elections are years away. Check out Populism, and Nationalism ASAP. Become "WHITE WOKE" & Push Back.

Do it today, NOW!

got me new papers there, but threatened me if I spoke out. We made it to Vienna, then to Turkey. I was kept in a bar and I was told I owed \$5,000 for my travel. I worked for three days, and on the fourth I was arrested." Lately, the ads have started to disappear from the main cities-- where the realities of such offers are known now. These days the appeals are made in the provinces, where their success is undiminished. Most of the thousands of Ukrainian women who go abroad each year are illegal immigrants who do not work in the sex business. Often they apply for a legal visa--to dance, or work in a bar--and then stay after it expires. Many go to Turkey and Germany, where Russian crime groups are particularly powerful. Israeli leaders say that Russian women--they tend to refer to all women from the former Soviet Union as Russian-- disappear off tour boats every day. Officials in Italy estimate that at least 30,000 Ukrainian women are employed illegally there now. Most are domestic workers, but a growing number are prostitutes, some of them having been promised work as domestics only to find out their jobs were a lie.

Part of the problem became clear in a two-year study recently concluded by the Washington-based nonprofit group Global Survival Network: police officials in many countries just don't care. The network, after undercover interviews with gangsters, pimps and corrupt officials, found that local police forces--often those best able to prevent trafficking--are least interested in helping. Gillian Caldwell of Global Survival Network has been deeply involved in the study. "In Tokyo," she said, "a sympathetic senator arranged a meeting for us with senior police officials to discuss the growing prevalence of trafficking from Russia into Japan. The police insisted it wasn't a problem, and they didn't even want the concrete information we could have provided. That didn't surprise local relief agencies, who cited instances in which police had actually sold trafficked women back to the criminal networks which had enslaved them." Official Reactions: Best-Placed to Help, But Least Inclined Complacency among police agencies is not uncommon. "Women's groups want to blow this all out of proportion," said Gennadi V. Lepenko, chief of Kiev's branch of Interpol, the international police agency. "Perhaps this was a problem a few years ago. But it's under control now." That is not the view at Ukraine's Parliament--which is trying to pass new laws to protect young women--or at the Interior Ministry. "We have a very serious problem here and we are simply not equipped to solve it by ourselves." said Mikhail Lebed, chief of criminal investigations for the Ukrainian Interior Ministry. "It is a human tragedy, but also, frankly, a national crisis.

Gangsters make more from these women in a week than we have in our law enforcement budget for the whole year. To be honest, unless we get some help we are not going to stop it." But solutions will not be simple. Criminal gangs risk little by ferrying women out of the country; indeed, many of the women go voluntarily. Laws are vague, cooperation between countries rare and punishment of traffickers almost nonexistent. Without work or much hope of a future at home, an eager teen-ager will find it hard to believe that the promise of a job in Italy, Turkey or Israel is almost certain to be worthless. "I answered an ad to be a waitress." said Tamara, 19, a Ukrainian prostitute in a massage parlor near Tel Aviv's old Central Bus Station, a Russian-language ghetto for the cheapest brothels. "I'm not sure I

would go back now if I could. What would I do there, stand on a bread line or work in a factory for no wages?" Tamara, like all other such women interviewed for this article, asked that her full name not be published. She has classic Slavic features, with long blond hair and deep green eyes. She turned several potential customers away so she could speak at length with a reporter. She was willing to talk as long as her boss was out. She said she was not watched closely while she remained within the garish confines of the "health club." "I didn't plan to do this." she said, looking sourly at the rich red walls and leopard prints around her. "They took my passport, so I don't have much choice. But they do give me money. And believe me, it's better than anything I could ever get at home." Yitzhak Tyler, the chief of undercover activities for the Haifa police, is a big, open-faced man who doesn't mince words. "We got a hell of a problem on our hands," he said.

The port city of 200,000 has become the easiest entryway for women brought to Israel to work as prostitutes--though by no means the only one. Sometimes they walk off tour boats, but increasingly they come with forged documents that enable them to live and work in Israel. These have often been bought or stolen from elderly Jewish women in Russia or Ukraine. "This is a sophisticated, global operation," Mr. Tyler said. "It's evil, and it's successful because the money is so good. These men pay \$500 to \$1,000 for a Ukrainian or Russian woman. Do you understand what I am telling you? They will buy these women and make a fortune out of them." To illustrate his point, Mr. Tyler grabbed a black calculator and started calling out the sums as he punched them in. "Take a small place," he said, "with 10 girls. Each has 15 to 20 clients a day. Multiply that by say 200 shekels. So say 30,000 shekels a day comes in to each place. Each girl works 25 days a month. Minimum." Mr. Tyler was busy doing math as he spoke. "So we are talking about 750,000 shekels a month, or about \$215,000. A man often owns five of these places. That's a million dollars. No taxes, no real overhead. It's a factory with slave labor. And we've got them all over Israel." The Tropicana, in Tel Aviv's bustling business district, is one of the busiest bordellos. The women who work there, like nearly all prostitutes in Israel today, are Russian. Their boss, however, is not. "Israelis love Russian girls." said Jacob Golan, who owns this and two other clubs, and spoke willingly about the business he finds so "successful." "They are blonde and good-looking and different from us." he said, chuckling as he drew his hand over his black hair. "And they are desperate.

They are ready to do anything for money." Always filled with half-naked Russian women, the club is open around the clock. There is a schedule on the wall next to the receptionist--with each woman's hours listed in a different color, and the days and shifts rotating, as at a restaurant or a bar. Next to the schedule a sign reads, "We don't accept checks." Next to that there is a poster for a missing Israeli woman. There are 12 cubicles at the Tropicana where 20 women work in shifts, 8 during the daytime, 12 at night. Business is always booming, and not just with foreign workers. Israeli soldiers, with rifles on their shoulders, frequent the place, as do business executives and tourists. Mr. Golan was asked if most women who work at the club do so voluntarily. He laughed heartily. "I don't get into that," he said, staring vacantly across his club at four Russian women sitting on a low couch. "They are brought here and told to work. I don't force them. I pay them. What

goes on between them and the men they are with, how could that be my problem?" Deterrent Strategies: A System That Fails Those Who Testify Every once in a while, usually with great fanfare and plenty of advance notice, Mr. Golan gets raided. He pays a fine, and the women without good false documents are taken to prison. If they are deported, the charges against them are dropped. But if a woman wants to file a complaint, then she must remain in prison until a trial is held. "In the past four years," Betty Lahan, prison director of Neve Tirtsa here, said, "I don't know of a single case where a woman chose to testify." Such punitive treatment of victims is the rule rather than the exception. In Italy, where the police say killings of women forced into prostitution average one a month, Parliament tried to create a sort of witness protection program. But it only allowed women to stay in the country for one year and did nothing to hide their identities. "The deck is just so completely stacked against the women in all this," said Daniella Pompei, an immigration specialist with the community of Sant'Egidio, the Catholic relief agency in Rome.

"The police is the last place these women want to go." She said that only 20 women had ever used the protection program. It is not clear who will stop the mob. On a trip to Ukraine late last year, Hillary Rodham Clinton spoke out about the new white slave trade that has developed so rapidly there. The United States and the European Union have plans to work together to educate young women about the dangers of working abroad. Other initiatives, like stays of deportation for prisoners, victims' shelters and counseling, have also been discussed. "I don't care about any of that," said Lena, a young Latvian, one of the inmates waiting to be deported here. "I just want to know one thing. How will I ever walk down the street like a human being again?"



William Wilberforce

On Friday July 26th 1833 as he lay on his deathbed Wilberforce exclaimed: "Thank God that I have lived to witness the day in which England is willing to give £20 million for the abolishment of slavery." (What would that be worth today ?) He died three days later.

The Slavery Abolition Bill 1833 passed through the House of Lords, it received the Royal Assent (which means it became law) on 29 August 1833 and came into force on 1 August 1834. On that date slavery was abolished throughout the vast British Empire. The Act automatically applied as new possessions (principally in Africa) subsequently became part of the British Empire.

To know who rules over you. Simply find out who it is that you are not allowed to criticise.Voltaire

We, as White people, have been GAGGED!! Then bullied, insulted, demonised, and provoked, until we object and complain. We then get called *dirty names* like Nazi, Racist, White Extremist, etc, etc.

Our weak & corrupt Lib/Lab/Con Politicians are the problem. As of Jan 2021, the UK elections are years away. Check out Populism, and Nationalism ASAP. Become "WHITE WOKE" & Push Back.

Do it today, NOW!

Sex Slavery In Israel Today



William Wilberforce

On Friday July 26th 1833 as he lay on his deathbed Wilberforce exclaimed: "Thank God that I have lived to witness the day in which England is willing to give £20 million for the abolishment of slavery." (What would that be worth today ?)

He died three days later.

The Slavery Abolition Bill 1833 passed through the House of Lords, it received the Royal Assent (which means it became law) on 29 August 1833 and came into force on 1 August 1834. On that date slavery was abolished throughout the vast British Empire.

The Act automatically applied as new possessions (principally in Africa) subsequently became part of the British Empire.

To know who rules over you. Simply find out who it is that you are not allowed to criticise.Voltaire

We, as White people, have been GAGGED!! Then bullied, insulted, demonised, and provoked, until we object and complain. We then get called *dirty names* like Nazi, Racist, White Extremist, etc, etc.

Our weak & corrupt Lib/Lab/Con Politicians are the problem. As of Jan 2021, the UK elections are years away. Check out Populism, and Nationalism ASAP. Become "WHITE WOKE" & Push Back.

Do it today, NOW!

local policemen were in cahoots with her "owners," because they were among the clients being "serviced" in one of the places in which she worked. ("They showed up in uniform," she relates, "with a squad car parked outside waiting for them.") But most of all she feared reprisal by her pimps. "They threatened that if I ran away, their people would track me down in Moldova and make sure I was punished."

AND SO, OVER THE COURSE OF 11 months, Victoria worked in various brothels, apartments and hotels in Beersheba and Tel Aviv from 10 a.m. to 11 p.m., seven days a week, "servicing" between 10 and 20 clients a day. Five times she was sold by one pimp to another, each new "owner" requiring her to work off her purchase price. Along the way, she was raped and sodomized by three of her "owners" and one's son, as well. When a brothel in which she was working was raided and she was taken to the police station, she produced the forged Israeli identity card given to her by her "owner" and claimed - as she had been instructed - that she had been in the country for three years. Seeing the identity card, the police asked no further questions, and Victoria was released back into slavery.

It was only on July 27, 2000, the second time she was arrested in a raid, that the police bothered to interrogate Victoria. "I showed them the forged identity card again, but this time they asked me detailed questions about my family - the family I supposedly had, according to the forged card - and I couldn't answer them. So although I was frightened, I told them the truth," she recalls.

Thus ended one ordeal and began another. As an illegal alien, Victoria was held for about a month in a local lock-up and then another two in the Neveh Tirzah Women's Prison in Ramleh, awaiting deportation, before she was discovered by the Hotline for Foreign Workers, a Tel Aviv NGO that focuses on the plight of illegal foreign workers. At first all she wanted was the Hotline's help in obtaining a proper travel document so that she could leave the country. But at some point Victoria also remembered that wronged people have a right to be angry.

"After more than a year of absolute hell, I'm going to be going back without a penny to show for everything that's happened!" she grumbled to Sigal Rozen, the director of the Hotline. So Rozen promptly suggested an idea she had been promoting to women in a similar situation for two years - without any takers.

"Why not get your deportation postponed - with the Hotline's help - so that you can stay and fight for your due?" Rozen proposed to Victoria. "Not only justice for those who have victimized you but just compensation for your labors."

So were born the three court cases currently being waged in Victoria's name or with her help. The first is a criminal case against three of her six "owners" and the errant son. The charges against them, it turns out, do not include trafficking in women, as Victoria was last "sold" a month before the amendment to the Penal Code made trafficking in human beings a crime in Israel. They do, however, include crimes equally as evil: rape and sodomy, in aggravated circumstances, among others.

The second is a civil case filed in the Beersheba District Labor Court in which Victoria, represented by the Hotline's energetic legal adviser, Nomi Levenkron, is suing all six of her "owners" for a combined total of almost \$200,000 in back wages, interest, and compensation for the pain, suffering, and anguish she endured while enslaved by them.

Of the thousands of women brought to Israel each year to work as prostitutes, many are enslaved, beaten and raped by their pimps.

From <http://www.themodernreligion.com/jihad/victoria.html>

Of the thousands of women brought to Israel each year to work as prostitutes, many are enslaved, beaten and raped by their pimps.

Now, one of them is fighting back...

If you were to pass her on the street, there's nothing particular about Victoria that would catch your eye. She could be your daughter, your sister, or your wife. In fact, before her ordeal began, she was a law student in the small Republic of Moldova, and she still has hopes of resuming her studies there. It is only when she begins to speak - barely above a whisper, in grammatically tortured Hebrew picked up "on the job" - that you sense, even become infected by, the fear in her voice, the sadness in her eyes, the exhaustion broadcast by her very posture. And only when you hear her story do you understand that this intelligent, un-assuming 21-year-old - one of the millions of people around the world who have been trafficked as prostitutes this year (see box) - is a heroine, not of some abstract international struggle for human rights but of a very private struggle to rise above the status of victim and take charge of her life again.

Ironically, it was a similar impetus that led Victoria (who asks that her last name not be published) into the nightmare she has been living for the past 16 months. In mid-1999, when she ran out of funds to continue her studies and found that her family would not help her, she was lured by the offer of a job in Israel as a masseuse. The promised monthly salary was \$1,000 (astronomical compared to the \$30 a month she was earning in Moldova), and she was assured that she could return there whenever she chose.

Victoria's suspicion that something was awry arose at the last moment, when the "job recruiter" equipped her with a false passport to travel via Romania. But it was only after she arrived in Israel, in August 1999, that she learned the truth about her new "job" from the man who met her at the airport, took the passport from her, and drove her to a town in the Negev. And the truth was harrowing: The "recruiter," she was told, had sold her into prostitution and debt bondage - meaning that she would have to work off her purchase price (\$6,500) before she could be released or even start earning a wage. She would also be required to have sex with her "owner" and his friends for free. The best she could expect for herself was tips from satisfied clients, which she soon discovered averaged \$4 to \$8 per john.

"We were locked in an apartment or under guard every time we moved from place to place," Victoria explains when asked why she didn't flee. "And even if I could get away, I had no passport, I had no money for a ticket to go back." Because she had entered Israel illegally, Victoria feared the law. She also had reason to suspect that



William Wilberforce

On Friday July 26th 1833 as he lay on his deathbed Wilberforce exclaimed: "Thank God that I have lived to witness the day in which England is willing to give £20 million for the abolishment of slavery." (What would that be worth today ?) He died three days later.

The Slavery Abolition Bill 1833 passed through the House of Lords, it received the Royal Assent (which means it became law) on 29 August 1833 and came into force on 1 August 1834. On that date slavery was abolished throughout the vast British Empire. The Act automatically applied as new possessions (principally in Africa) subsequently became part of the British Empire.

To know who rules over you. Simply find out who it is that you are not allowed to criticise.Voltaire

We, as White people, have been GAGGED!! Then bullied, insulted, demonised, and provoked, until we object and complain. We then get called *dirty names* like Nazi, Racist, White Extremist, etc, etc.

Our weak & corrupt Lib/Lab/Con Politicians are the problem. As of Jan 2021, the UK elections are years away. Check out Populism, and Nationalism ASAP. Become "WHITE WOKE" & Push Back.

Do it today, NOW!

burned to death in a locked brothel, with bars on the windows, in Tel Aviv last August - and then it goes back to sleep again," says Gruenpeter-Gold.

One reason for the lack of sustained attention by the government and media is that prostitution, per se, is not illegal in Israel (and neither was trafficking in human beings until last July). What is criminal is "procurement," which the law defines as taking some or all of the profits of a woman so engaged. In short, it is pimps who stand to spend up to five years in prison (seven under aggravated circumstances) for their actions. Yet in the case of trafficked women, it is the prostitutes who have been consistently punished by Israel's law-enforcement agencies - as illegal aliens - by being arrested, detained for weeks, and deported, while the owners of brothels have gotten off scot-free.

Another reason for the lack of vigor in attacking the problem is that Israeli officials, to this day, seem somewhat ambivalent about just how victimized the trafficked women are.

"From talks with hundreds of women awaiting deportation in Neveh Tirzah, I can tell you that only an isolated number claim they were deceived about what awaited them here - meaning they had answered an ad for a job as an au pair or a model or something similar," says Herzl. "The overwhelming majority came here knowing what they would be doing and how much they were likely to earn," which is an estimated \$700-\$1,000 a month. Many of these women, Herzl concedes, failed to anticipate the harsh physical conditions or how hard they would be required to work. "But the great majority of the women who have come here to work in prostitution do get paid for it," he stresses. "Before being deported, quite a few have even told me that they intend to come back, as this is the only way they can improve their economic situation."

Activists dispute this overview, saying that while they simply don't know what proportion of the women are here against their will, it's a far from isolated phenomenon. Still, testimonies like those cited by Herzl

probably made it easier to turn a blind eye to the egregious violations of human rights often entailed in the sex trafficking business. And typically, perhaps, it took an outside party to rub Israel's nose in this problem.

That service was provided last May by Amnesty International, which issued a blistering 23-page report on trafficking in women in Israel that slammed the government for "[failing] to take adequate measures to prevent, investigate, prosecute and punish human rights abuses against trafficked women" from the former Soviet Union. The report included a list of specific recommendations, among them: making slavery and trafficking unlawful; establishing a special unit to deal with the investigation and prosecution of abuses; treating women as victims rather than criminals; opening a hostel for trafficked women (detaining them in prison, pending deportation, only as a last resort); and providing them with legal aid, counseling, and medical services, as well as tools to request asylum when they face danger if returned to their native lands.

Clearly, official Israel was stung by the reproof. On June 13, 2000, the Knesset established a special commission of inquiry into trafficking in women, headed by Meretz Knesset member Zahava Gal-On. At the end of July, the Penal Code was amended to making trafficking in human beings a crime whose perpetrators are liable to up to 16 years in prison (20 for trafficking in a minor). And most recently,

The third is a petition to the Supreme Court for an injunction ordering the minister of internal security, the interior minister, and the Israel Police to pay for Victoria's upkeep (\$1,500 a month, though there are legal precedents for demanding twice that amount) until she can testify in the criminal case.

Since being released from the Neveh Tirzah Prison early last November, Victoria has been living, in hiding from her former enslavers and with no police protection, off the kindness of strangers. She is not getting the medical attention she wants. She is not receiving the psychological counseling she needs. "There are times when I'd just like to go window shopping in a mall to cheer up a bit," she says. "But that would only remind me how utterly destitute I am."

"The terms of her release from detention prohibit Victoria from working during the remainder of her stay in Israel," Levenkron explains. "So who's taking care of her? Well, if having our volunteers stand up at the end of a law class, tell Victoria's story, and pass around the hat is 'seeing to her needs,' then yes, I suppose you can say we're taking care of her."

VICTORIA'S CIVIL SUIT AND Supreme Court appeal for maintenance are unprecedented in Israel. But many aspects of her plight are so common to the thousands of trafficked women engaged in prostitution in Israel that one must wonder why the phenomenon has been allowed to continue for so long.

Indeed, Chief Superintendent Avi Davidovich, head of the Investigations Division in the national headquarters of the Israel Police and head of a new interministerial committee on trafficking in women, notes that the problem has been growing since the beginning of the 1990s.

"Four factors have fostered it," Davidovich explains: "The rapid growth of Israel's population and thus the number of men who seek sexual services; the growth in the number of foreign workers, mostly single men, who have become major consumers of such services; the opening of borders and freer movement worldwide, especially migration from the Commonwealth of Independent States (CIS); and an erosion of social norms in Israel."

"Israelis have simply grown used to the idea that women can be bought," concurs Leah Gruenpeter-Gold, co-director of the Awareness Center in Tel Aviv, which specializes in research on trafficking in women and prostitution. "I wouldn't say sex trafficking has burgeoned here largely because of the foreign workers - show me one who can afford \$60 an hour for a prostitute. It's far more because of the changed norms of young Israelis - both married men and single men who don't want to enter into a relationship so they purchase sex."

The influx of 1 million immigrants from the CIS over the past decade has also made it easier for the crime syndicates operating there - whose tentacles reach deep into Israel - to traffic women with forged documents. "Some prostitutes come in under the forged identities of Jewish women in Russia and the Ukraine," explains Hagay Herzl, an advisor to the internal security minister on foreign-workers issues. "They even receive the rights and benefits accorded to immigrants by the Law of Return."

Yet even though the problem is a veteran and particularly ugly one, trafficking in women has only hiccupped its way through the discussion of Israel's struggle with a growing population of illegal foreign workers. "It crops up from time to time, the press gives it a blast of coverage - like when the four Russian prostitutes were



William Wilberforce

On Friday July 26th 1833 as he lay on his deathbed Wilberforce exclaimed: "Thank God that I have lived to witness the day in which England is willing to give £20 million for the abolishment of slavery." (What would that be worth today ?) He died three days later.

The Slavery Abolition Bill 1833 passed through the House of Lords, it received the Royal Assent (which means it became law) on 29 August 1833 and came into force on 1 August 1834. On that date slavery was abolished throughout the vast British Empire. The Act automatically applied as new possessions (principally in Africa) subsequently became part of the British Empire.

To know who rules over you. Simply find out who it is that you are not allowed to criticise.Voltaire

We, as White people, have been GAGGED!! Then bullied, insulted, demonised, and provoked, until we object and complain. We then get called *dirty names* like Nazi, Racist, White Extremist, etc, etc.

Our weak & corrupt Lib/Lab/Con Politicians are the problem. As of Jan 2021, the UK elections are years away. Check out Populism, and Nationalism ASAP. Become "WHITE WOKE" & Push Back.

Do it today, NOW! 71

All in all, press clippings over the past six months seem to suggest a slightly heightened awareness of the problem, and talks with officials suggest that the state is finally beginning to address it. But the apparent change of attitude is still nowhere near the energetic campaign that the organizations grappling with the issue of trafficking would like to see adopted.

"Neglect, sheer neglect is why we've reached this point," says Levenkron, and Gruenpeter-Gold adds: "I wish I could say that something has seriously changed since the law was amended last July, but I can't."

"Just two months ago, we had a hard time getting the police interested in even hearing Victoria's testimony," reports the Hotline's Rozen. "They said it would be her word against that of her pimps, and they couldn't build a case on that. It was only after I had testified before the Knesset inquiry commission that the police called back to say they would like to see her. They were shamed into it. And we should all be ashamed that things like this exist in our 'enlightened,' democratic society and we still prefer to turn the other way."

Marxist Generals - Ethnic Soldiers - White Victims - Worldwide



KILL A WHITE
ON SIGHT
THEIR SILENCE IS VIOLENCE
What would the UK Government and UK Media do about any organisation like this?
#BLACKLIVESMATTER
#ANTIFA
#WLM #MSCOTLAND #AVENGESLAVERY

an interministerial committee, composed of representatives of the Justice, Interior, Internal Security, and Labor and Social Affairs ministries, has begun to address many of the issues spotlighted by the Amnesty Report.

Perhaps most telling of all, officials like Davidovich and Herzl are now clearly speaking of trafficked women as "victims" and of the need to prosecute the traffickers and pimps, rather than the women they victimize.

Expectations of what this thrust of interest and activity can accomplish, given budgetary constraints, vary. "We're not talking about eradicating [sex trafficking], just containing its spread and reducing its scope," says Davidovich. "And it's clear that the police cannot take on the establishment of hostels or other aspects of a witness-protection program to encourage these women to testify in criminal cases."

But Herzl is far more upbeat, saying that he intends to raise the idea of a witness-protection program with the incoming minister. He also reports that the police have been directed to embark on "quality, in-depth investigations - not against the women but against the importers, the pimps, the people who run the whole business." And he promises that "in the near future, you'll see the results of these activities. We are determined to deal with the phenomenon head on," he says, "with the aim of reducing it to the point of eliminating it."

MEANWHILE, OUT IN THE field, the hue has yet to turn rosy. The Knesset's commission of inquiry held only two sessions before its six-month mandate expired, and now there are procedural obstacles to automatically renewing it. A judge in Beersheba has been known to assign trafficked women to be held in detention, until their deportation, in the very brothel where they worked - stipulating, of course, that they must not engage in prostitution! And the Awareness Center has learned that the City of Rishon Lezion, south of Tel Aviv, has been issuing business licenses to brothels; the city had not responded by press time to an inquiry on this from The Report.

Even more dismaying is the fact that the first trial based on the new anti-trafficking clause of the Penal Code ended in mid-February with a whimper: a plea bargain - proposed by the prosecution - in which the offender received a mere two-year sentence. The case would probably not have come to trial at all had it not been for the fact that one of the victim's johns - a kibbutznik - fell in love with her (and vice versa), tried to redeem her from bondage by paying off her "owner," shelled out an advance, and then got stung by the greedy pimp, who proceeded to "sell" her elsewhere. Only then - and after the love-struck kibbutznik had managed to "kidnap" his prospective bride from her captor - was the matter taken to the police.

"Evidently the State Attorney's Office also has to be educated about the new outlook on trafficking," says Gruenpeter-Gold bitterly, while the Hotline's Levenkron has registered an official protest with the Tel Aviv district attorney over the plea bargain.

Speaking of education, Gruenpeter-Gold suggests that the Education Ministry also be represented on the interministerial committee dealing with trafficking, and Levenkron would add the Foreign Ministry to its list of members, explaining that an Israeli information campaign in the CIS could go a long way toward attacking the problem at its source.

DIVERSITY for DUMMIES

It's just basic Arithmetic. To say you want more Ethnic Diversity is exactly the same as saying that you want 'Less' of the Ethnicity that you have already got.

How RACIST is that ?

In 2011 native British Whites became a minority group in London.

The same is true of a number of other large British cities.

Am I a racist ? Absolutely not ! I want more ethnic minorities every bit as much as they want more of me.

How much is that ?

When any minority is 'Positively' selected.

It means that many White People have been '**Racially Profiled**' to be discriminated against, and sent to the back of the queue.

UNDER ACHIEVING WHITE SCHOOL KIDS for DUMMIES

If Ethnic school children under achieve, the teacher gets sent on a 'Unconscious Bias' training course.

Or some other sort of disciplinary action.

No such fear if the White kids fail !

So, guess who gets most care and attention from the teacher ?

It's been like that for years now. On purpose !

But don't complain if you're White !

You know what will happen to you !

On Times Radio on Tuesday October 13th 2020 @ about 10.20am, there was some concerned sounding official saying that we must look into why White children fail in UK schools, and not be afraid of asking politically difficult questions.

That's EXACTLY what he was doing !! The spineless Ba***rd.

Marxist Generals - Ethnic Soldiers - White Victims - Worldwide.

VOTE POPULIST - AND DO IT QUICK !!

REAL HISTORY for DUMMIES

Some years ago I was sitting in a Pub and a Black girl on a table near to me was holding court with her friends and quite loudly explaining how Black people had not done all of the bad and evil things done by White people.

After listening for a while I said

"There's a very simple reason for that"

What ? She asked.

I replied...

What have you done ?

"SILENCE"

There's your answer I said.

(Out of politeness, I did not mention the many hundreds of years long history of Black African Slave Traders)

BLACK LIVES MATTER for DUMMIES

"The concept of envy — the hatred of the superior — has dropped out of our moral vocabulary ...

The idea that white Christian civilization is hated more for its virtues than its sins doesn't occur to us, because it's not a nice idea. ...

Western man towers over the rest of the world in ways so large as to be almost inexpressible. It's Western exploration, science, and conquest that have revealed the world to itself. Other races feel like subjects of Western power long after colonialism, imperialism, and slavery have disappeared.

The charge of racism puzzles whites who feel not hostility, but only baffled good will, because they don't grasp what it really means: humiliation. The white man presents an image of superiority even when he isn't conscious of it.

And, superiority excites envy. Destroying white civilization is the inmost desire of the league of designated victims we call minorities.

—Joseph Sobran (Sobran's — April 1997)"

THE FUTURE OF THE USA for DUMMIES

In January 2021 the unthinkable happened and the USA was Hijacked by a Left Wing cartel. Donald Trump and his supporters had their election victory stolen from them.

There is very much worse to come. There will never be another Republican party in power in the USA.

From here on in, there will just be ever increasing MARXIST Anti White Totalitarianism.

Amongst other 'Extremist' measures, Joe Biden is set to give amnesty & voting rights to 11,000,000 illegals.

On top of this, he will import even more votes from the 3rd world.

The same sort of thing has been happening in the UK since the end of WW2 in 1945. As soon as that war was over, Left Wing 'Sleepers' or 'Fifth Columnists' crawled out of the woodwork to start forcing cultural MARXISM (Diversity, Multi-Culti etc) on an already war battered British people.

These days, some on the Left openly admit that's what they did.

If any 'Patriotic' British people tried to object they were shouted down and compared to the war criminals of Wartime Nazi Germany and Imperial Japan. This 'Race Card' is still being used today, but with lesser effect.

To say that you want more Ethnic Diversity is exactly the same as saying that you want LESS of the ethnicity that you have already got. How racist is that ?

**WOKE up White People WOKE up !!
Get WOKE - And Stay AWAKE !!**



William Wilberforce

On Friday July 26th 1833 as he lay on his deathbed Wilberforce exclaimed: "Thank God that I have lived to witness the day in which England is willing to give £20 million for the abolishment of slavery." (What would that be worth today ?)

He died three days later.

The Slavery Abolition Bill 1833 passed through the House of Lords, it received the Royal Assent (which means it became law) on 29 August 1833 and came into force on 1 August 1834.

On that date slavery was abolished throughout the vast British Empire.

The Act automatically applied as new possessions (principally in Africa) subsequently became part of the British Empire.

To know who rules over you.

Simply find out who it is that you are not allowed to criticise.

.....Voltaire

We, as White people, have been GAGGED!! Then bullied, insulted, demonised, and provoked, until we object and complain. We then get called *dirty names* like Nazi, Racist, White Extremist, etc, etc.

Our weak & corrupt Lib/Lab/Con Politicians are the problem. As of Jan 2021, the UK elections are years away. Check out Populism, and Nationalism ASAP. Become "WHITE WOKE" & Push Back.

Do it today, NOW!

THE GREAT RESET for DUMMIES

The Great Reset may, or may not, be real. Only time will tell, and it will show in the next few months, not years. Consider all that has happened so far, and then watch what takes shape in the future.

Then decide.
But, if it exists, it has one essential requirement that you can do something about.

That requirement is to have an essentially "Cashless" society. These days Banks and shop tills can sterilise cash non stop. UV light is just one option.

Demand the right to pay, and be paid, in CASH !

MULTICULTURALISM for DUMMIES

Nationalism
= DIVERSITY
Multiculturalism
= MELTING POT
= No DIVERSITY

WHITE WOKE for DUMMIES

"Remember The First Commandment"

1 - Woke up ! And stay Awake !

Then be friendly and wear a pleasant smile, as we Woke together towards our own agenda. Just like the other people.

At all future elections vote for one of the Populist or Nationalist parties.

No matter what, never again give your vote to any of the Lib/ Lab/Con tricksters.

For years now at home and in schools, White people have been told to be colour blind.

GET WOKE QUICK !!
Marxist Generals - Ethnic Soldiers - White Victims - Worldwide.

LOCKDOWNS for DUMMIES

The greatest form of control is "Dependency"
State induced COVID19 panic, with loans, bail outs, lockdowns, rules, subsidies etc, etc. It all adds up to massive 'Dependency' It means years, even generations, of Debt. Debt = Slavery. Debt to WHO ? And where did THEY get that money to start with ? They are in fact exactly the same international financiers that financed or should we say 'Invested' in the Russian revolution of 1917. **Who is BoJo listening to ?**

Covid19 has a death rate on a par with Winter Flu. Perhaps less.

The EU project was an attempt to re-create the MARXIST society that failed in the USSR. BREXIT has damaged that beyond repair. After Britain leaves and succeeds, other countries will follow.

Communism & MARXISM have always been about getting all power and wealth into the hands of the chosen. (Champagne Socialist anyone ?) Concern for the 'Workers' is just a means to an end, nothing more. Is the current COVID19 fraud, an attempt to bring in Communism by the back door. **Who is BoJo listening to ?**

At first we had the scare stories from China with images of huge Hospitals being built in no time flat, along with video on YouTube of Chinese police forcing people from their homes and into Hospitals. We saw officials walking in the streets with rifles. We heard shots being fired. We saw people laying in the street. But I can't recall seeing anybody actually shot down in the street.

Pure Hollywood !!
Then our own media have taken over from there.

There is just so much about this 'COVID' thing that does not add up.

COMMUNISM for DUMMIES

Nobody in the entire history of human politics since the advent of Communism, has ever risked their life to go and live in a Communist country to pursue a better life. At least nobody sober.

You can vote Communism and MARXISM into power. But, you always, always, always, have to 'Shoot' your way out if you want to leave it again.



William Wilberforce
On Friday July 26th 1833 as he lay on his deathbed Wilberforce exclaimed: "Thank God that I have lived to witness the day in which England is willing to give £20 million for the abolishment of slavery." (What would that be worth today ?) He died three days later.

The Slavery Abolition Bill 1833 passed through the House of Lords, it received the Royal Assent (which means it became law) on 29 August 1833 and came into force on 1 August 1834. On that date slavery was abolished throughout the vast British Empire. The Act automatically applied as new possessions (principally in Africa) subsequently became part of the British Empire.

To know who rules over you. Simply find out who it is that you are not allowed to criticise.Voltaire

We, as White people, have been GAGGED!! Then bullied, insulted, demonised, and provoked, until we object and complain. We then get called *dirty names* like Nazi, Racist, White Extremist, etc, etc.

Our weak & corrupt Lib/Lab/Con Politicians are the problem. As of Jan 2021, the UK elections are years away. Check out Populism, and Nationalism ASAP. Become "WHITE WOKE" & Push Back.

Do it today, NOW!

It's A Wonderful Race !

By James Bronson

There once was a college freshman named George. Who thought he knew it all.

One night over dinner, George got into an argument with his father. The argument began when the young student tried to explain to his father that as White people, they should be held accountable for all the evils that they had inflicted upon non-Whites throughout history. George explained: Because of European racism, we stole the Indians' land, we held blacks in slavery, we persecuted the Jews, and we plundered the environment. We've been oppressive



racists for thousands of years so it's only fair that we pay economic reparations for all the harm we've done to the world. I'm pleased to see that we are ending our political and economic domination of the oppressed peoples.

George's dad was shocked to hear such talk. Who put such commie-pinko nonsense into your head, boy? Did one of your sandal-wearing hippie college professors teach you that? the father asked. To which the son replied:

That's the truth dad.

My anthropology professor, Dr.Irving Silverstein, says so.

He ought to know. Dr. Silverstein is a well-respected Ph.D. People of your generation just don't understand because you were raised in a White supremacist racist society. That's why I've come to admire Dr. Rev. Martin Luther King as the greatest man in American history. He stood up to the racists of your generation. Because of him, my generation of White kids is completely colourblind.The father angrily replied: That's bullshit! I've always been fair-minded and tolerant of people from all backgrounds and races. I haven't 'oppressed' anybody, and furthermore there's nothing wrong with being proud of one's own people, including the European race of people. Your race is in your blood. It's like an extension of your biological family and you ought to be proud of your European heritage and identity, just like every other racial group in America is proud of its.

Why is it OK for them to have a strong sense of racial identity but it's evil for us Europeans to feel that way? The young intellectual laughed at his father.

Come on dad, that's the kind of crap Hitler tried to peddle.

Those racist attitudes were discredited years ago. There's only one race and that's the human race. Diversity is our greatest strength. Differences in so-called race are as insignificant as differences in belly buttons.

And besides, UN statistics now show that low White birth rates, along with the fact that we live in an multicultural society, will mean that Europeans and their ethnocentrist and racist culture will have died out by the end of the century, young George said.Turning red with anger, the father yelled:

You are a walking cliché?

You know that boy?

And you think it's a good thing that the European peoples of the world will have faded out and ceased to exist?Young George replied; I think it's great! It will mean the end of racism and the end of hate. The oppressed peoples of the world would have been better off if us racist Europeans had never existed to begin with.

Suddenly there was a blast of cold wind, an explosion, and a huge smoke cloud.



When the smoke had settled, George found himself alone and lost in a cold open field. An angel named Clarence then appeared to him and said Well George, you've got your wish. George asked: Where am I? What's going on here? And who are you? The angel answered, George, I'm Clarence the Angel. I was sent here to show you what the world would have been like if Europeans, or Whites, had never existed. You now live in a world where Europeans never existed.

Oh. That's cool. I'll have no problem adapting because there's not a racist bone in my body. And when I get back to my world, I'll be able to tell my professor and my friends how great this non-racist world was. Say, I'm freezing my ass off out here. Where's the nearest motel? Motel? replied the angel. There are no motels here in what was once called North America. But there are some caves up in those mountains where you can find shelter.

Caves?

No way man. I want a nice warm bed to sleep in.

I don't think you understand George.

There are no buildings here in non-white America because the evil Europeans never came here to build them. Whites never existed, remember?

The natives live in tents.

Would you like to go meet some local Indians? Perhaps they'll let you stay in a tent.

A tent? But it's 10 degrees outside?...Oh well. It's better than a cave I suppose.



William Wilberforce

On Friday July 26th 1833 as he lay on his deathbed Wilberforce exclaimed: "Thank God that I have lived to witness the day in which England is willing to give £20 million for the abolishment of slavery." (What would that be worth today ?)

He died three days later.

The Slavery Abolition Bill 1833 passed through the House of Lords, it received the Royal Assent (which means it became law) on 29 August 1833 and came into force on 1 August 1834. On that date slavery was abolished throughout the vast British Empire.

The Act automatically applied as new possessions (principally in Africa) subsequently became part of the British Empire.

To know who rules over you. Simply find out who it is that you are not allowed to criticise.Voltaire

We, as White people, have been GAGGED!! Then bullied, insulted, demonised, and provoked, until we object and complain. We then get called *dirty names* like Nazi, Racist, White Extremist, etc, etc.

Our weak & corrupt Lib/Lab/Con Politicians are the problem. As of Jan 2021, the UK elections are years away. Check out Populism, and Nationalism ASAP. Become "WHITE WOKE" & Push Back.

Do it today, NOW!



William Wilberforce
 On Friday July 26th 1833 as he lay on his deathbed Wilberforce exclaimed: "Thank God that I have lived to witness the day in which England is willing to give £20 million for the abolishment of slavery." (What would that be worth today ?)
 He died three days later.

The Slavery Abolition Bill 1833 passed through the House of Lords, it received the Royal Assent (which means it became law) on 29 August 1833 and came into force on 1 August 1834. On that date slavery was abolished throughout the vast British Empire. The Act automatically applied as new possessions (principally in Africa) subsequently became part of the British Empire.

To know who rules over you. Simply find out who it is that you are not allowed to criticise.Voltaire

We, as White people, have been GAGGED!! Then bullied, insulted, demonised, and provoked, until we object and complain. We then get called *dirty names* like Nazi, Racist, White Extremist, etc, etc.

Our weak & corrupt Lib/Lab/Con Politicians are the problem. As of Jan 2021, the UK elections are years away. Check out Populism, and Nationalism ASAP. Become "WHITE WOKE" & Push Back.

Do it today, NOW!

inventions created by evil White men. What? !! You mean to tell me that in the year 2002 these people still haven't figured out a way to keep themselves or their food cool? a frustrated George asked.

No George, they haven't. And they never will.

This is ridiculous. Let's go to the main city to see the Emperor. I can't live like like this. Where's a car...oh I forget...no cars! Dammit I'll walk. Let's go. After walking through the jungle for about an hour or so, it began to get dark. George then asked Clarence to give him a flashlight so that he could see. Flashlight? Sorry George, but Thomas Edison was an evil White man too...and he was never born. There are some branches over there if you want to make a torch.Never mind that! George shouted back. By morning time, Clarence and George had arrived at the temple of the Incans. A bloody human sacrifice was in progress. George turned to Clarence and cried, They're going to butcher that poor soul! Somebody has got to stop this. What horrible murdering beasts! Can't anyone stop them? The angel replied I'm afraid not. Ritual killings are common place here. Those evil European racists like Columbus, Cortez and Pizzaro never existed so the Incans just continued their brutal ways. In fact, it was the oppressed peoples themselves who made up the bulk of the Spanish armed forces.

The people saw the Spaniards as liberators who would rid them of the oppressive Incan and Mayan rulers and give them a better life.

I can't blame them for helping the Spaniards then. This is a horrible place. Get me out of this shithole now! said George. 'Where would you like to go? Clarence replied.George said: Take me to Africa, maybe there's a more advanced and humane civilization there that I can fit into. Where the nearest airport? Oh, I forgot...no Wright Brothers. George said. How about a boat? Boats? replied the angel. I'm afraid the most seaworthy rafts available to you won't be of much help in crossing the vast Atlantic Ocean. The great Viking sailors and European navigators never existed. No Phoenicians, no Leif Erikson, no Henry the Navigator, no Columbus, no Magellan, no Hudson and no Robert Fulton. Even if you could build your own ship, there would be no compass for you to navigate with and no



sextant either. I'm afraid you're stuck here George. Can I touch your robe and fly to Africa then asked George. You're cheating again George, but all right. Touch my robe and we'll fly to Africa. When they arrived in Africa, George saw thousands of half-naked African tribesmen being herded along a dirt path.They were guarded by other Africans with spears. What are they doing to those poor men? George asked Clarence.

Let's go talk to these Indians..... Wait a second, are these Indians friendly or hostile? Why, George, that's a racist question to ask. Just because some Indians were brutal savages who scalped their victims alive, it doesn't mean they all were said the angel sarcastically. I know that Clarence. And I'm not a racist. I hate racism. Nonetheless, I'd feel safer if I could have a gun to defend myself if they turn out to be violent.

Gun? replied the angel.

There are no guns for you to defend yourself with.

Firearms were invented by evil Europeans.

Though we could make a spear with those twigs over there.That's too much work. Give me a telephone then. I'll call the Indians to ask if it's OK.Telephone? replied the angel. There are no telephones here. Alexander Graham Bell was another evil white man, so he never existed. No Europeans remember? Forget it then replied George. I'll sleep in the damn cave.Upon arriving at the cave, a shivering George asked the angel for a lighter so that he could light a fire. A lighter? replied Clarence. There are no lighters here, and no matches. Those are European gadgets and evil Europeans never existed remember? If you want to get warm, you need to do like the locals do and start rubbing twigs together.

Oh come on man! You mean to tell me these people still rub sticks together for fire?That's right George. The Indians live exactly as they did before the evil pilgrims arrived from Europe just a few centuries ago. said the angel sarcastically.I refuse to stay in this cold cave and I damn sure ain't gonna light a fire with twigs, and I refuse to sleep in a teepee. I'll go to South America. I can make it in a warmer climate and I'll adapt quickly to the great Incan civilization I learned about at college. Since European racists like Columbus, Cortez and Pizzaro never existed,

the Incans will still be there. ... I need a car. Car? replied the angel. There are no cars here. Daimler and Benz, the evil German inventors of the internal combustion engine, were never born..nor was Henry Ford. There are no paved roads either. This is a world without evil Europeans remember? No cars! Oh. I'll just have to take a train. There are no trains in this world either George. Evil Europeans weren't here to build locomotive engines or to discover the many uses of coal, oil and gas, or to build

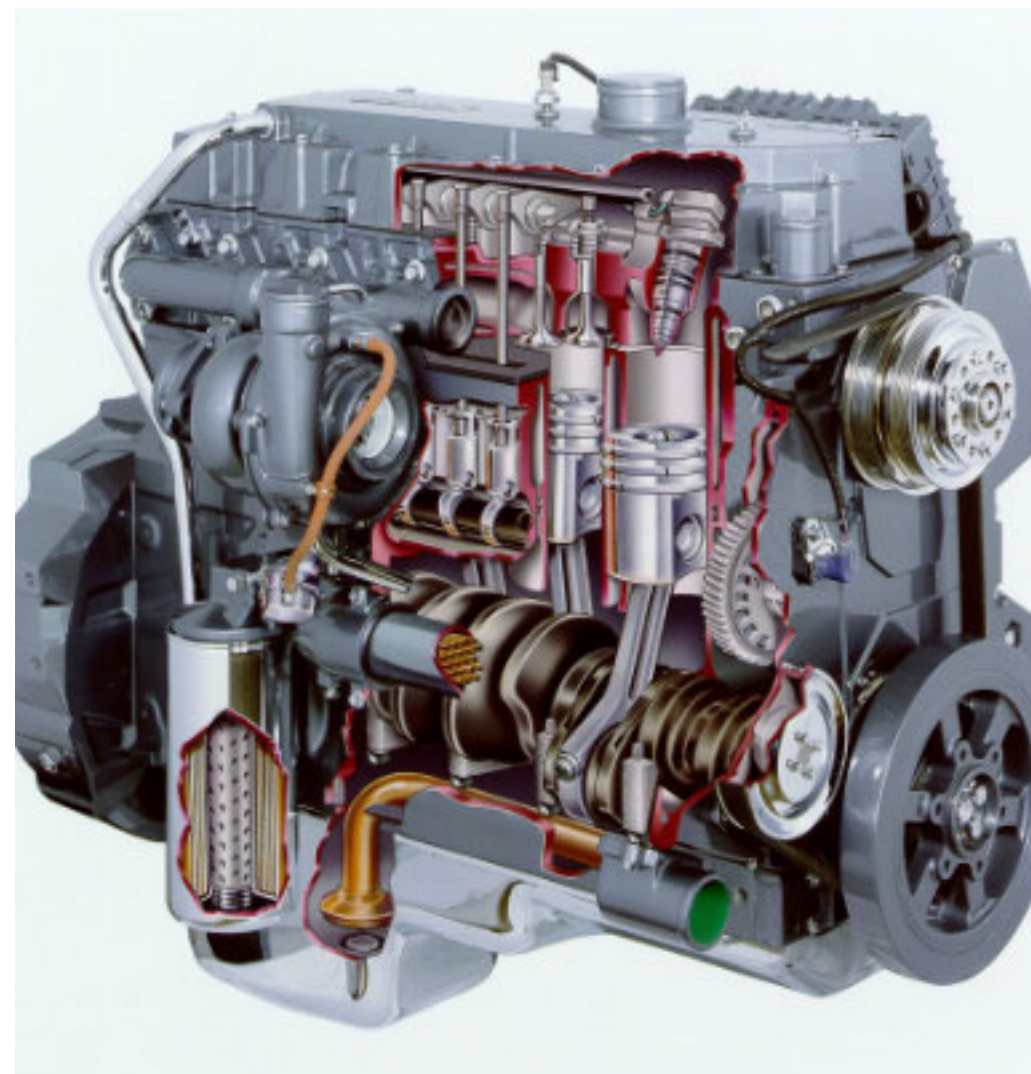

trains or lay tracks. But I'll allow you to cheat just a bit. Grab hold of my magic robe and we'll fly south. George touched the angel's robe and they flew south until they arrived in an abandoned mud hut in the midst of Incan territory. George was grateful for the warm weather but it wasn't long until he began to complain about the heat and humidity. Clarence, this hut is a little shithole and I'm sweating up a storm here. Get me an air-conditioner please. Air-conditioner? replied the angel. There are no air-conditioners here. Air conditioning and refrigeration were

They are being enslaved by another tribe. Slavery was common in Africa long before the whites arrived, Clarence said.

In fact, most of the slaves who were shipped to the Americas were sold to the slave traders by African tribal leaders. That's so sad.' George said. I want to meet Martin Luther King. Since his White assassin never existed, this great man should still be alive. He's probably a great tribal chief somewhere and leader of an advanced civilization. He will free these slaves from their African masters. Take me to him Clarence. Clarence led George to a little hut deep in the heart of Africa. The naked women and children looked at George in wonder. The young men were out on a hunt but the older men stayed behind. George was led to the dingy little hut of the tribal witch doctor and spiritual leader. There he saw a wild-looking man with a necklace of teeth around his neck and a huge ring pierced through his nose. What the hell is that? George asked. Meet Witch-doctor Matunbo Lutamba Kinga Clarence said. He never became Reverend Martin Luther King because there were no universities or seminaries built to educate him. Europeans weren't there to create such opportunities. But he did become the tribe's spiritual leader. He specializes in casting evil spells. Perhaps he can help you? The witch doctor gazed in wonder at George. Then he motioned to his henchmen to seize young George. The tribesmen grabbed hold of George and tied him to a nearby tree. Stop it! Let me go. What are they going to do to me? cried George hysterically. They're going to perform a ritual killing on you George. The good doctor King...I mean Kinga -- believes that by cutting your heart out while you are still alive, it will bring good fortune and fertility to his tribe, laughed Clarence. Clarence! Clarence! Help me Clarence! Help me! But George, you told me that you wanted to go to Africa and to meet your hero Reverend King. George said: This part of Africa has not developed yet. I can see that now. Take me to North Africa where Egypt and Carthage established great civilizations. Just get me out of here, please. Just as the witch doctor's spear was about to carve out George's heart, George vanished into thin air. He then found himself on the banks of the river Nile in Egypt. Thank you Clarence. Thank you, George said. I don't understand it Clarence. Why does so much of the world remain so brutal and primitive? I learned during Black History Month about many talented black inventors and scientists. Garrett Morgan, George Washington Carver, Benjamin Banneker, Granville Woods. Then there's Dr. Carson, the preeminent brain surgeon in all of America. Where are these men? Clarence replied: Don't you understand yet? America, and Africa, exist exactly as they did before the Europeans discovered them. Civilization as you had known it, had only been introduced to these people just a few centuries ago by the Europeans. There are no universities, no hospitals, no means of transportation other than animals, no science, no medicine, no machines.

In fact, the wheel hasn't even been discovered in Sub-Saharan Africa!

Those black scientists, inventors, doctors, athletes, and entertainers you speak of were never given the opportunity to realize their full human potential because Europeans weren't around to introduce higher civilization and learning to them. There are no George Washington Carvers in this non-European world, no Dr. Carsons, no Booker T. Washingtons, no Benjamin Bannekers, no Michael Jordans, no Oprah Winfreys, no Bill Cosbys, no... Stop it! That can't be! cried George. Let's walk over to the great pyramids of Egypt right now and I'll show you one of the great wonders of the worldbuilt by non-Whites. They walked a few miles before George stopped and asked where the nearest toilet was. Toilets? replied

the angel. There are no toilets or urinals in this world. Plumbing was developed by evil Europeans. The people in this non-White world still relieve themselves in open fields. Clarence turned around so George could do his business. I need some toilet paper. George said. Toilet paper? replied the angel. There...I know. I know. Toilet paper hasn't been invented yet. Just hand me a rag then. Clarence obliged and the two of them went on their way. I don't understand. According to my recollections from Geography class, the great pyramids should be near this very spot. We ought to be able to see them from miles away, said George.

Well, George, I'm sure your professors at the college never told you this, but the ancient Egyptians were not black or brown. They were Caucasians.

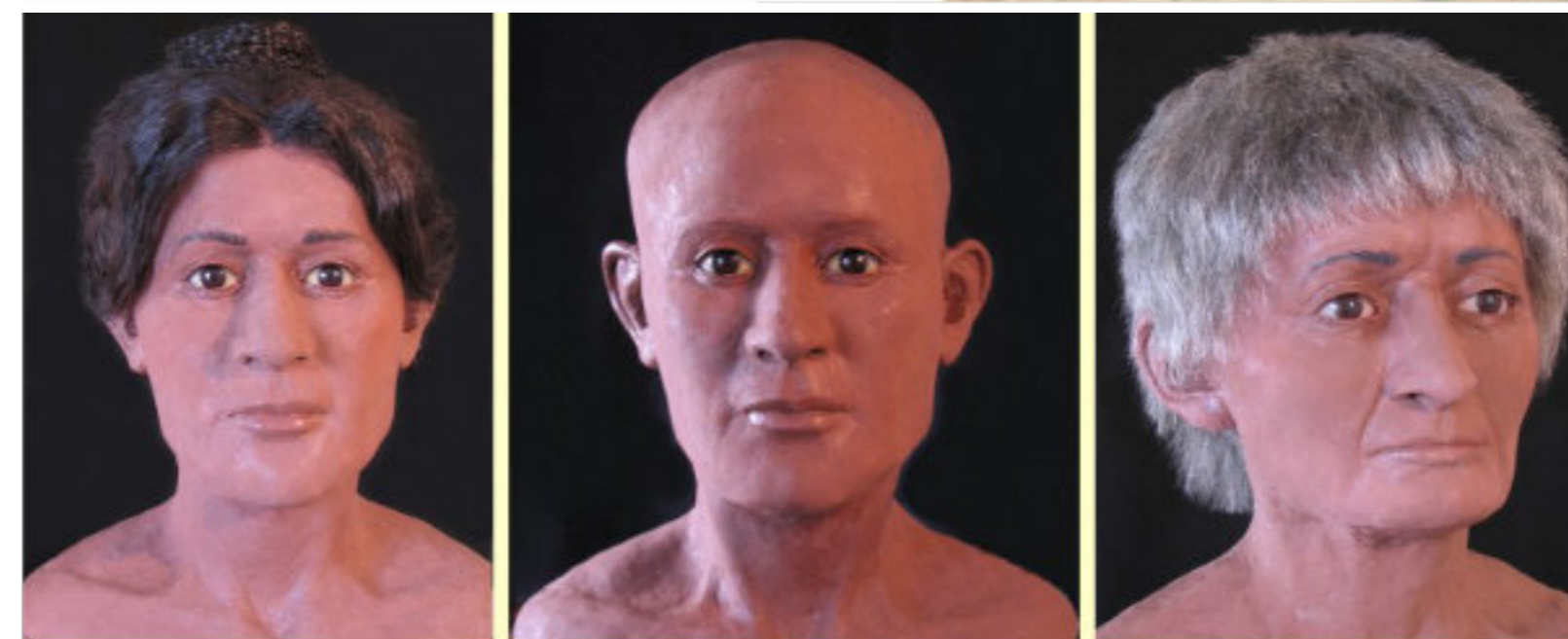

Professional forensic artist Victoria Lywood worked with a team of researchers at the Redpath Museum in Montreal to create 3D models of three ancient Egyptian mummies of people who died circa 2,000 years ago - **during the period of Roman rule.**
NOTE: Egyptian period of **GREEK** rule (332 B.C.-30 B.C.). Egyptian period of **ROMAN** rule (30 B.C.-627 A.D). Egyptian period of **ARAB** rule (627 A.D. - 868). Egyptian period of **TURK** rule {including Mamlukes} (868 A.D. - 1516 A.D.) Egyptian period of **OTTOMAN TURK** rule (1516 A.D. - 1918)



They've settled down a bit but life is much the same as it is in North America. A nomadic existence based on hunting and food gathering. No great cities, no science, no buildings, no culture, no fine art - just a hard daily struggle against life

The anthropologists who examined the Egyptian mummies confirmed this fact. There are no pyramids and no Sphinx either. And the Carthaginians were White too.

George became depressed, but he was determined to prove his beliefs. What's in Europe? he asked. Europe became populated by Huns and other Asiatic tribes.



William Wilberforce
On Friday July 26th 1833 as he lay on his deathbed Wilberforce exclaimed: "Thank God that I have lived to witness the day in which England is willing to give £20 million for the abolishment of slavery." (What would that be worth today?)
He died three days later.

The Slavery Abolition Bill 1833 passed through the House of Lords, it received the Royal Assent (which means it became law) on 29 August 1833 and came into force on 1 August 1834. On that date slavery was abolished throughout the vast British Empire. The Act automatically applied as new possessions (principally in Africa) subsequently became part of the British Empire.

To know who rules over you. Simply find out who it is that you are not allowed to criticise.Voltaire

We, as White people, have been GAGGED!! Then bullied, insulted, demonised, and provoked, until we object and complain. We then get called *dirty names* like Nazi, Racist, White Extremist, etc, etc.

Our weak & corrupt Lib/Lab/Con Politicians are the problem. As of Jan 2021, the UK elections are years away. Check out Populism, and Nationalism ASAP. Become "WHITE WOKE" & Push Back.

Do it today, NOW!

and the elements of nature. In a Europe without evil Whites, the Roman Empire never existed nor did the Greeks. There was no Renaissance either. Take me to Asia then. Surely the great civilizations of Persia, India, China, and Japan will suit me George said. Clarence, to the Taj Mahal please. The Taj Mahal? replied the angel. Don't you know that the ancient Persian and Indian civilizations were established by ancient Indo-European tribes who crossed the Himalayas? They are the ones who civilized India and built the Taj Mahal. Those are the great civilizations that Marco Polo, Columbus, and others were searching for. Did you know that Iran is Persian for land of the Aryan? George said: Don't tell me that the Indians were White men! That can't be. In the world I came from, I knew many Indians and they were not White! Clarence explained: As the centuries passed, the Indo-Europeans who created Indian civilization intermarried with the native majorities who populated the Indian subcontinent. Gradually there were less and less evil White people until they faded out completely, along with the advanced civilization they had built.

You will notice that there are still a few white-skinned and fair-haired Indians and Pakistanis around today -- in the world you came from that is.



Pakistani Kalash Girl

George became worried. He knew he could never fit into the harsh primitive world he had been thrust into. Suddenly he thought of Japan. Japan! I'll show you now Clarence. Take me to Japan. If the Japanese can make TVs and cameras then I'm sure I'll find a decent civilization that I can live in. Clarence transported George to Japan. George observed that Japanese society was the most orderly, advanced and civil that he had seen, but it seemed as if almost everyone was either a rice farmer, a fisherman, or a soldier.

There were no cars, no skyscrapers, no lights, no stereos, no sciences, no technologies, no universities. It was a stagnant agricultural society that seemed to have reached its high water mark and was incapable of moving forward. George knew he could not live here either. Clarence explained to George: Even the industrious Japanese and Chinese peoples had to rely on the evil Europeans to build the modern Asia that you had in mind. In this world, Japan exists exactly as it did before Commodore Perry's American naval ships arrived in Japan in the 1850s. There's no industry, no technology, no Fuji film, no Sony, no Hitachi, no Panasonic, no Toyota, no Sushi bars, no baseball...none of the trappings or comforts of modern life. These things don't exist in Japan or anywhere else because Europeans weren't there to create them and share them with the rest of the world. Would you care for a bowl of rice George? George began to feel sick in both his body and his mind. Not only was he depressed, but exposure to the harsh elements of nature had left him physically ill. Clarence, I seem to have contracted some type of sickness. I must have some antibiotics. Anti-biotics? There's no...Oh Shut up already! Then just take me back to the world as it was! Sorry George. I'm not authorized to do that. Only my boss can make that call.

Clarence said to him: You see George. Your father was right. You really had a wonderful race.

Don't you see what a foolish mistake it is to be ashamed and guilty about your own people, and to let them die out? This is what the world would be like without the creative spark of Edison and Ford and Pasteur and Marconi. No great scientists, or mathematicians, or inventors or fine artists. No Archimedes, no Aristotle, no Socrates, no Alexander, no Renaissance, no Newton, no Kepler, no Goddard, no Mendel, no Tesla, no Faraday, no Guttenberg, no Shakespeare, no Dickens, no Twain, no Mozart, no Beethoven, no Da Vinci, no Michelangelo, no Galileo, no Copernicus. No Venice, no Paris, no Lisbon, no Madrid, no Zurich, no Berlin, no St. Petersburg, no Budapest, no Rome, no Milan, no Vienna, no London, no New York, no Rio, no Sydney. No orchestras, no museums, no universities, no hospitals, no libraries, no theaters, no radio, no books, no television, no electricity, no refrigeration, no heating, no plumbing, no houses, no steel, no stadiums, no vaccines, no cars, no planes, no trains, no ships, no dentists, no surgeons, no computers, no telephones, and most important - there's no creative genius to be found that could create and sustain such a high level of civilization.

There's nothing for the people of this world to build upon. It's just a daily struggle for subsistence. A brutal planet where the few people who aren't mired in eternal ignorance and darkness have reached their peak of civilization and are advancing no further. Clarence went on to lecture the broken and depressed young man for seven days straight. He covered everything. History, science, economics, philosophy, art, literature, fine music, architecture, medicine, politics, agriculture, religion, and all the creations and contributions that the European peoples had made in every conceivable field of human endeavor. George listened closely to every word. He felt like a man who had been reborn. After his lecture, Clarence the Angel floated away towards heaven. I hope you have found all this to be educational, and I hope you have learned an important lesson. Enjoy your world George! mocked the departing angel. George began to sob like a baby. It was the year 2002 and he was alone and hungry in a backwards world where Europeans had never existed. He cried out to the stars: Please God. I see what a fool I've been. I understand now what my father was trying to tell me. I want to go back to the world that I came from. A world where Europeans not only existed, but blessed the rest of humanity with their unique creative ability. I want to live in a civilized world. **Please God!...take me back!...take me back!...Oh God....please.**



William Wilberforce

On Friday July 26th 1833 as he lay on his deathbed Wilberforce exclaimed: "Thank God that I have lived to witness the day in which England is willing to give £20 million for the abolishment of slavery." (What would that be worth today?) He died three days later.

The Slavery Abolition Bill 1833 passed through the House of Lords, it received the Royal Assent (which means it became law) on 29 August 1833 and came into force on 1 August 1834. On that date slavery was abolished throughout the vast British Empire. The Act automatically applied as new possessions (principally in Africa) subsequently became part of the British Empire.

To know who rules over you. Simply find out who it is that you are not allowed to criticise.Voltaire

We, as White people, have been GAGGED!! Then bullied, insulted, demonised, and provoked, until we object and complain. We then get called *dirty names* like Nazi, Racist, White Extremist, etc, etc.

Our weak & corrupt Lib/Lab/Con Politicians are the problem. As of Jan 2021, the UK elections are years away. Check out Populism, and Nationalism ASAP. Become "WHITE WOKE" & Push Back. **Do it today, NOW!**

Suddenly George was transported back to his college dormitory.

Drunk with joy, George jumped into the showers before he could even take his clothes off! Warm water! and soap! Life is beautiful! he screamed. George's floor mates looked at him as if he was crazy. George! Have you gone crazy? asked a bewildered schoolmate. No my friend. I haven't taken leave of my senses. I've come to them! George replied. George then began to sing classic European folk songs in the shower. Miraculously, he was able to sing in many different languages. He sang O Sole Mio in Italian, Amazing Grace in English, Gloire Immortelle in French, Das Ist Der Tag in German, and also Belgian, Spanish and French ballads and waltzes. Tears of sheer joy began to stream down his cheeks. The degenerate music of Hip-Hop and Rap lost all of its appeal to young George. After his shower, George drove to a nearby restaurant and ordered two whole entrees. One was Lasagna and the other was a delicious Veal Marsala. With his Italian food he had a Greek salad with Spanish olives and Russian dressing, drank a whole bottle of French wine, followed by a German pastry for dessert. He finished his meal off with a hot cup of English tea and a Cuban cigar. George said out loud: Oh those European peoples and their delicious cuisine. Clarence was right after all. What a wonderful race! George was happy, but at the same time he realized there was much work to be done. He thought of all those poor whites in Rhodesia and South Africa who were being murdered and raped ever since they gave up control of those once-European nations. He thought of the many thousands of qualified Whites who were passed up for good jobs and college entrance because of racial quotas that discriminate against Europeans. He thought about the declining birthrates among all the European nations of the world. He remembered that Europeans everywhere were dwindling in numbers every year even as their own nations were being flooded with third world immigration.

He recalled the O.J. Simpson verdict and how millions of blacks in America cheered when that brutal double murderer was set free by a black jury after he stabbed two Whites to death.



He remembered the Los Angeles riots of 1992, where dozens of Whites were dragged out of their vehicles and killed like dogs in the streets by packs of White-hating monsters who were never even punished!



He remembered the time when Jesse Jackson led a cheer at Stanford University: Hey Hey Ho Ho, Western Civ. has got to go!



William Wilberforce
On Friday July 26th 1833 as he lay on his deathbed Wilberforce exclaimed: "Thank God that I have lived to witness the day in which England is willing to give £20 million for the abolishment of slavery." (What would that be worth today ?)
He died three days later.

The Slavery Abolition Bill 1833 passed through the House of Lords, it received the Royal Assent (which means it became law) on 29 August 1833 and came into force on 1 August 1834. On that date slavery was abolished throughout the vast British Empire. The Act automatically applied as new possessions (principally in Africa) subsequently became part of the British Empire.

To know who rules over you. Simply find out who it is that you are not allowed to criticise.Voltaire

We, as White people, have been GAGGED!! Then bullied, insulted, demonised, and provoked, until we object and complain. We then get called *dirty names* like Nazi, Racist, White Extremist, etc, etc.

Our weak & corrupt Lib/Lab/Con Politicians are the problem. As of Jan 2021, the UK elections are years away. Check out Populism, and Nationalism ASAP. Become "WHITE WOKE" & Push Back. **Do it today, NOW!**



William Wilberforce

On Friday July 26th 1833 as he lay on his deathbed Wilberforce exclaimed: "Thank God that I have lived to witness the day in which England is willing to give £20 million for the abolishment of slavery." (What would that be worth today ?)
He died three days later.

The Slavery Abolition Bill 1833 passed through the House of Lords, it received the Royal Assent (which means it became law) on 29 August 1833 and came into force on 1 August 1834. On that date slavery was abolished throughout the vast British Empire. The Act automatically applied as new possessions (principally in Africa) subsequently became part of the British Empire.

To know who rules over you. Simply find out who it is that you are not allowed to criticise.
.....Voltaire

We, as White people, have been GAGGED!! Then bullied, insulted, demonised, and provoked, until we object and complain. We then get called *dirty names* like Nazi, Racist, White Extremist, etc, etc.

Our weak & corrupt Lib/Lab/Con Politicians are the problem. As of Jan 2021, the UK elections are years away. Check out Populism, and Nationalism ASAP. Become "WHITE WOKE" & Push Back.
Do it today, NOW!



His European blood began to boil in righteous indignation when he recalled how Jesse Jackson once said he had spit in White people's food when he was a young restaurant worker. George now understood that that his people were on a collision course with worldwide disaster and genocide. George realized that this great people must not perish from the face of the earth. George could not wait to see his father. He longed to embrace him and apologize for all of the foolish and disrespectful things he had said to him. But first, George had a score to settle with a certain college professor. He walked into Dr. Silverstein's auditorium and quietly took a seat in the back row. The nasal voiced Silverstein was lecturing on and on about racial and gender inequalities in European-centered civilizations. It was vintage Silverstein. George's impressionable White schoolmates, with their baggy pants, hip-hop clothes and backwards baseball caps, were swallowing Silverstein's poison pills hook, line and sinker. After letting Silverstein spew his cultural poison for about 15 minutes or so, George raised his hand so that he could give the professor a piece of his newly educated mind. George? Is that you? I remember you from last semester. I wasn't aware that you were here today. I failed to recognize you in that shirt and tie, and without your earrings. You must have enjoyed my course so much that you signed up again eh? Class, I'd like for you to meet George. He was one of my brightest students last semester. He truly has a thorough grasp of the ideas presented in this course. George, would you be so kind as to tell my class about that brilliant term paper you wrote about European racism, imperialism, and the need for monetary reparations?

That's when young George let loose on the unsuspecting Professor.



ENOUGH! You scheming devil! You mendacious fabricator of falsehoods! You pusillanimous purveyor of pinko propaganda! How dare you try to corrupt and manipulate our young minds with your filthy lies. We Europeans have nothing to be ashamed of, nothing to apologize for, and everything to be proud of.

And most of all, we don't owe anybody jack shit - not one thin dime!

To the contrary, it is the rest of humanity that owes us a debt which can never be repaid! We are the rightful heirs and protectors of a rich cultural heritage. You vile manipulator! We are the sons of the Romans, the sons of the Greeks, the Celts, the Vikings, the Normans, the Saxons. Why do you inflict shame and guilt upon us?

We Europeans didn't just contribute to civilization... WE ARE CIVILIZATION !

And I declare that I will no longer tolerate you shit head intellectuals trying to tear our people down.



William Wilberforce

On Friday July 26th 1833 as he lay on his deathbed Wilberforce exclaimed: "Thank God that I have lived to witness the day in which England is willing to give £20 million for the abolishment of slavery." (What would that be worth today ?) He died three days later.

The Slavery Abolition Bill 1833 passed through the House of Lords, it received the Royal Assent (which means it became law) on 29 August 1833 and came into force on 1 August 1834. On that date slavery was abolished throughout the vast British Empire. The Act automatically applied as new possessions (principally in Africa) subsequently became part of the British Empire.

To know who rules over you. Simply find out who it is that you are not allowed to criticise.Voltaire

We, as White people, have been GAGGED!! Then bullied, insulted, demonised, and provoked, until we object and complain. We then get called *dirty names* like Nazi, Racist, White Extremist, etc, etc.

Our weak & corrupt Lib/Lab/Con Politicians are the problem. As of Jan 2021, the UK elections are years away. Check out Populism, and Nationalism ASAP. Become "WHITE WOKE" & Push Back.

Do it today, NOW! 80

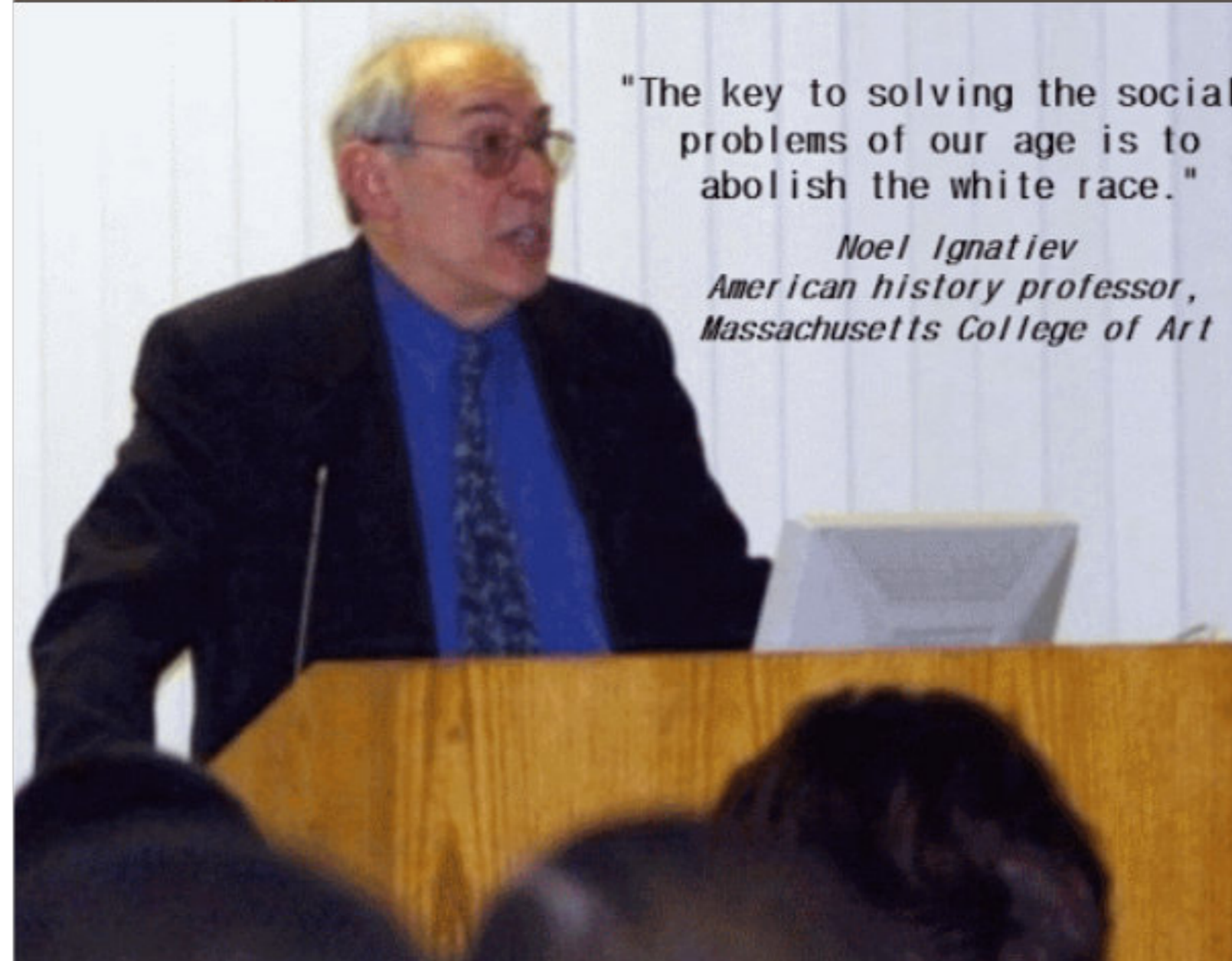

Silverstein's greatest fear was that more of these proud European youths would one day awaken and take their country and civilization back from the Silversteins of the world. Silverstein was worried, but he remained confident that most young men and women would never learn the truth about their glorious past and unique creative abilities. After all, the mass media, Hollywood, the music industry, the colleges, and the public schools are all controlled by liberals like Dr. Silverstein. With the power of political correctness in their hands, they can continue to tear down our European ancestors, destroy our institutions and traditions, instigate blacks and other races against the whites, flood America with third-world immigration, and push hip-hop music, homosexuality, and other garbage onto a weak, confused and morally degenerate youth. After reflecting upon these facts, Silverstein smiled a devilish grin and muttered to himself: A few of these European sheep may wake up to what's being done to them, but the majority of these idiots never will. And he smiled again....and laughed with diabolical Marxist glee.

Then he repeated to himself No...they will never figure it all out until it's too late.

Or will they?

Never again will we walk on eggshells when we speak, always fearing that we might be called racist. I no longer care what people think. All that matters is the truth which you have sought to pervert! What are you up to anyway? Why do you to corrupt my young peers by shoving false heroes down their throats. Enough of your Marxist games of divide and conquer, you commie pinko subversive! I don't want to learn anymore about Martin Luther King, Jesse Jackson, Al Sharpton or Black History Month. They would not have amounted to anything without the institutions of high civilization created by the European peoples. I'm going to set this class straight about who the truly great men of history are - the European statesmen, scientists, explorers, monarchs, navigators, conquerors, inventors, artists, writers, philosophers - the innovative giants of history that you and your ilk have erased from our collective memories. You speak of a world liberated from European influence? Permit me tell your students about such a world, Silverstein, because I can speak from personal experience, you wretched little conspiring monster! Silverstein turned white as a ghost. He was shell shocked and rendered speechless for the first time in his career! Never in all of his years at the University had a student dared to so boldly challenge his falsehoods. Speaking from the heart as well as the mind, and with an eloquence he never thought he could muster, George broke out into a 60-minute monologue on history, science, philosophy, culture, and all the other attributes that constitute high civilization. The young students were captivated by George's brilliant oratory. Many were moved to tears. By the end of his tirade, George's reawakened classmates were thundering their approval of his speech. The class gave George a standing ovation and they thanked him for helping them rediscover and reclaim their own sense of pride and lost identity. The unstoppable power of truth had melted away years of Marxist guilt tripping, self hate, wimpishness and cultural brainwashing in just one unforgettable hour. The inspired students proceeded to storm out of Silverstein's class, throwing their hip-hop baseball caps and nose earrings at him as they stampeded out and vowed never to return. They lifted George up upon their shoulders and carried him out of the auditorium like a conquering hero. With a glint in his eye, George glanced up towards the sky, winked and said Thank you, Clarence.

Dr. Silverstein was left humiliated and visibly shaken. He knew that these reawakened European kids could never again be brainwashed with political correctness and White guilt.

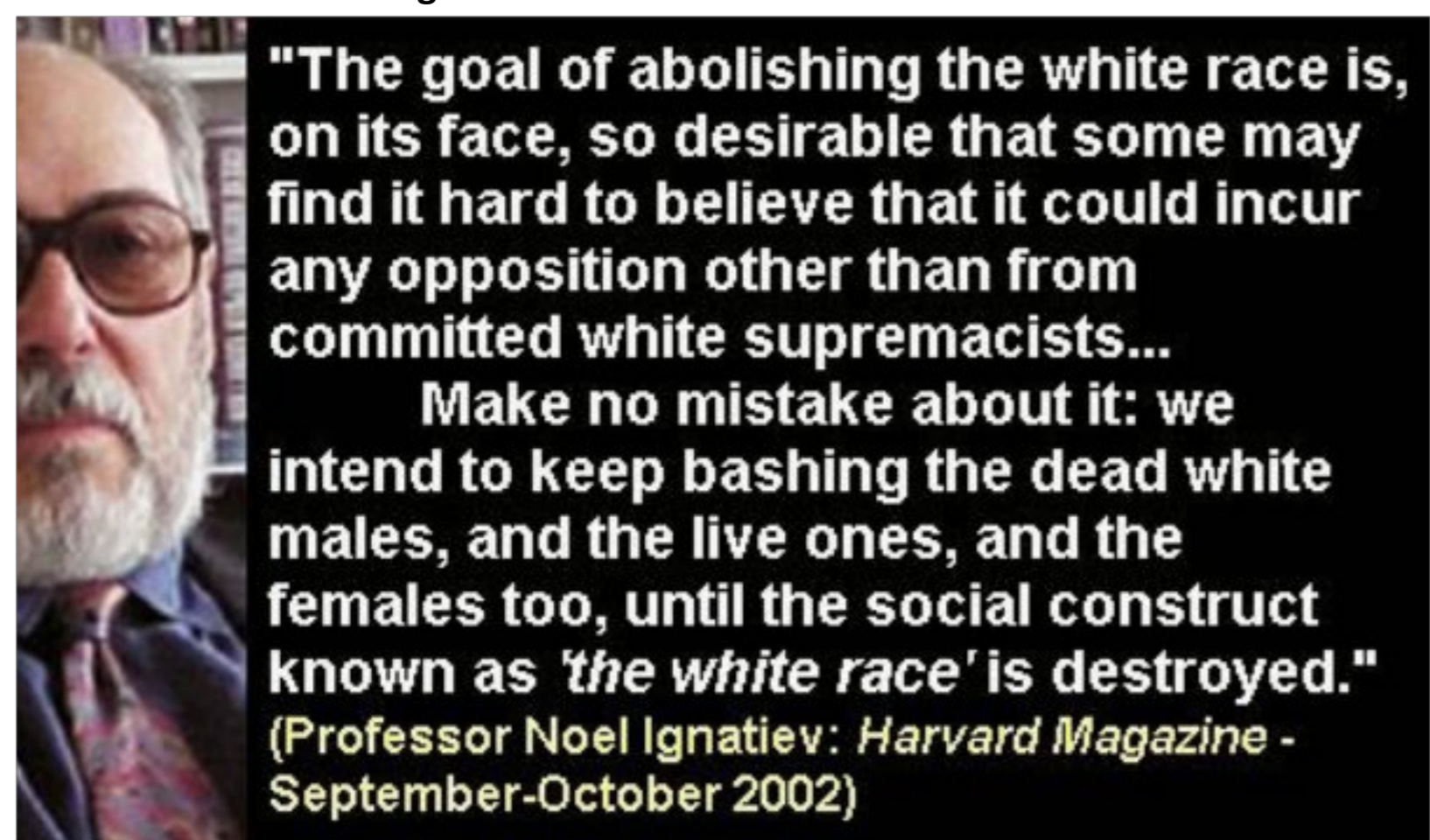

Dr Noel Ignatiev - Destroy The White Race

Harvard Hates The White Race?

By Paul Craig Roberts

<https://vdare.com/articles/harvard-hates-the-white-race>

Is the multicultural campaign really about diversity?

Or is it about stamping out Western civilization and the “white race” itself?

College students will tell you that a university education today is a guilt trip for whites. The purpose is to prevent whites from appreciating and absorbing their own culture and to make it difficult for whites to resist the unreasonable demands (quotas, reparations, etc.) from “people of color.”

To the questions, “who am I, what am I,” the white university graduate answers: “a racist, sexist, homophobic oppressor.”

Neither parents, trustees, alumni, nor the public are aware of the anti-white propaganda that masquerades as education. When someone who is aware tells them, they think the person is exaggerating in order to make a point.

Now comes Harvard educated Noel Ignatiev, an academic at Harvard’s W.E.B. DuBois Institute for African-American Research. Dr. Ignatiev is the founder of a journal, Race Traitor, which has as its motto, “treason to whiteness is loyalty to humanity.”

The journal's purpose is 'to abolish the white race.'

At the least, Dr. Ignatiev intends cultural and psychological genocide for whites. It is unclear whether physical extermination is part of the program.

A statement by the editors on the web site says that the new abolitionists

“do not limit themselves to socially acceptable means of protest, but reject in advance no means of attaining their goal.”

Dr. Ignatiev does not believe his agenda is controversial. He writes:

“The goal of abolishing the white race is on its face so desirable that some may find it hard to believe that it could incur any opposition other than from committed white supremacists.”

Thus does he put whites on notice.

If they oppose their abolition, they are “white supremacists.”

According to Dr. Ignatiev,

“The key to solving the social problems of our age is to abolish the white race.”

“Make no mistake about it,” he says,

“we intend to keep bashing the dead white males, and the live ones, and the

females too, until the social construct known as ‘the white race’ is destroyed, not ‘deconstructed’ but destroyed.”

What “social construct” will be left? A black one? An Hispanic one? Muslim? Asian? What about Jewish?

The Washington Times reports that Dr. Ignatiev is himself Jewish. If Jewish intellectuals and Israeli political leaders can be believed, Jews have a cultural and racial consciousness. Israel is the Jewish homeland, and Israelis seem determined to keep it that way.

Can anyone imagine a gentile at an Israeli university founding a magazine devoted to abolishing the Jewish race?

Yet, Dr. Ignatiev believes that it is self-evident that whites in their homelands should be abolished. Where did he get this view? His only education was at Harvard where he received two graduate degrees.

Is Harvard embarrassed? No. Dr. Ignatiev [ignatiev@fas.harvard.edu] is showcased in the current issue of Harvard Magazine. Getting rid of whiteness is not controversial at Harvard, because it is the business of American universities.

A white skin, you see, is a mark of privilege. It is not the privilege of being admitted to Harvard even though you don’t meet the entrance requirements. It is not the privilege of being hired independently of ability because of government enforced racial quotas. It is not the privilege of being able to sue whites and “white companies” if blacks are not proportionately represented in the work force. It is not the privilege of being able to call whites every name in the book and sue if a white replies in kind.

The privilege of being white is that whites can secretly believe they are superior and, as long as they don’t mention it, be loyal to the white race.

“The white race is like a private club,” says Dr. Ignatiev.

I am sure Dr. Ignatiev is well-informed, but I see no signs of this white loyalty. Most of the multiculturalists and radical feminists are white.

Whites disadvantaged whites by imposing racial quotas.

Despite widespread opposition to quotas, neither “white” political party will act to stop unconstitutional quotas, which have made a mockery of equality under law.

Whites are inundated by massive non-white immigration, and neither “white” political party will act to restrain immigration.

To the contrary, both parties pander to the immigrants.

But Dr. Ignatiev has an idea like Hitler. A race is guilty and must go.

The communists said it was a guilty class that had to go.

If you thought genocide was left behind in the 20th century, be apprised that today genocide has a home in the educational system.

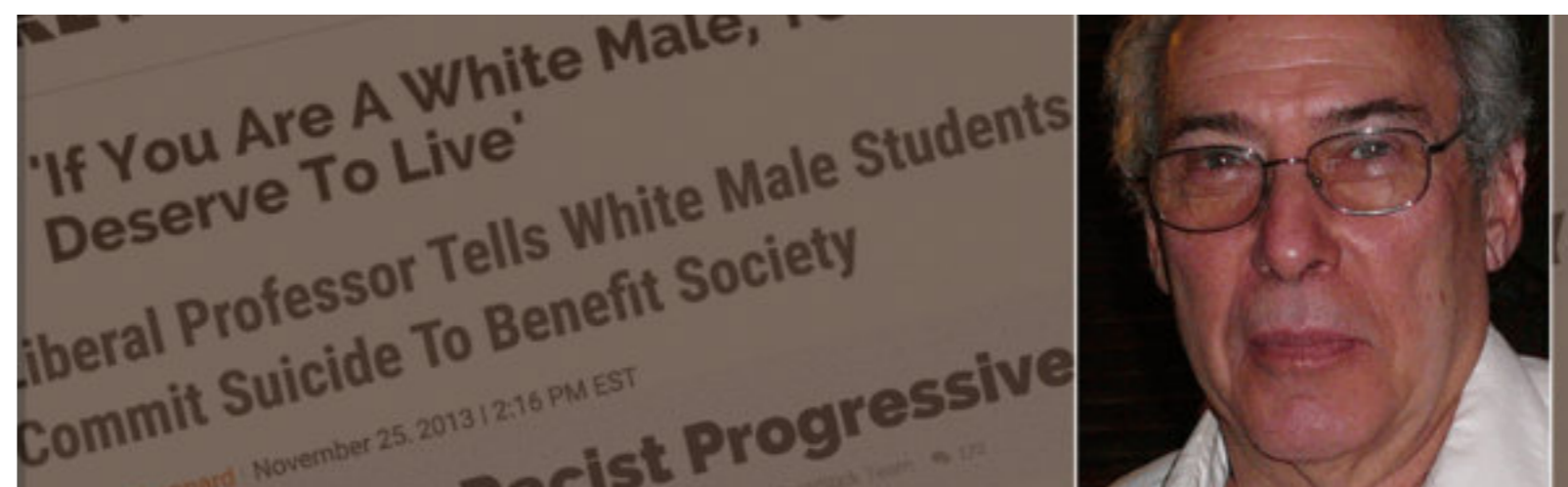

William Wilberforce

On Friday July 26th 1833 as he lay on his deathbed Wilberforce exclaimed: "Thank God that I have lived to witness the day in which England is willing to give £20 million for the abolishment of slavery." (What would that be worth today?)

He died three days later.

The Slavery Abolition Bill 1833 passed through the House of Lords, it received the Royal Assent (which means it became law) on 29 August 1833 and came into force on 1 August 1834.

On that date slavery was abolished throughout the vast British Empire.

The Act automatically applied as new possessions (principally in Africa) subsequently became part of the British Empire.

To know who rules over you. Simply find out who it is that you are not allowed to criticise.Voltaire

We, as White people, have been GAGGED!! Then bullied, insulted, demonised, and provoked, until we object and complain. We then get called *dirty names* like Nazi, Racist, White Extremist, etc, etc.

Our weak & corrupt Lib/Lab/Con Politicians are the problem. As of Jan 2021, the UK elections are years away. Check out Populism, and Nationalism ASAP. Become "WHITE WOKE" & Push Back.

Do it today, NOW!

The World Is A Better Place Because Of The White Man



William Wilberforce
 On Friday July 26th 1833 as he lay on his deathbed Wilberforce exclaimed: "Thank God that I have lived to witness the day in which England is willing to give £20 million for the abolishment of slavery." (What would that be worth today ?)
 He died three days later.

The Slavery Abolition Bill 1833 passed through the House of Lords, it received the Royal Assent (which means it became law) on 29 August 1833 and came into force on 1 August 1834. On that date slavery was abolished throughout the vast British Empire. The Act automatically applied as new possessions (principally in Africa) subsequently became part of the British Empire.

To know who rules over you. Simply find out who it is that you are not allowed to criticise.Voltaire

We, as White people, have been GAGGED!! Then bullied, insulted, demonised, and provoked, until we object and complain. We then get called *dirty names* like Nazi, Racist, White Extremist, etc, etc.

Our weak & corrupt Lib/Lab/Con Politicians are the problem. As of Jan 2021, the UK elections are years away. Check out Populism, and Nationalism ASAP. Become "WHITE WOKE" & Push Back. **Do it today, NOW!**

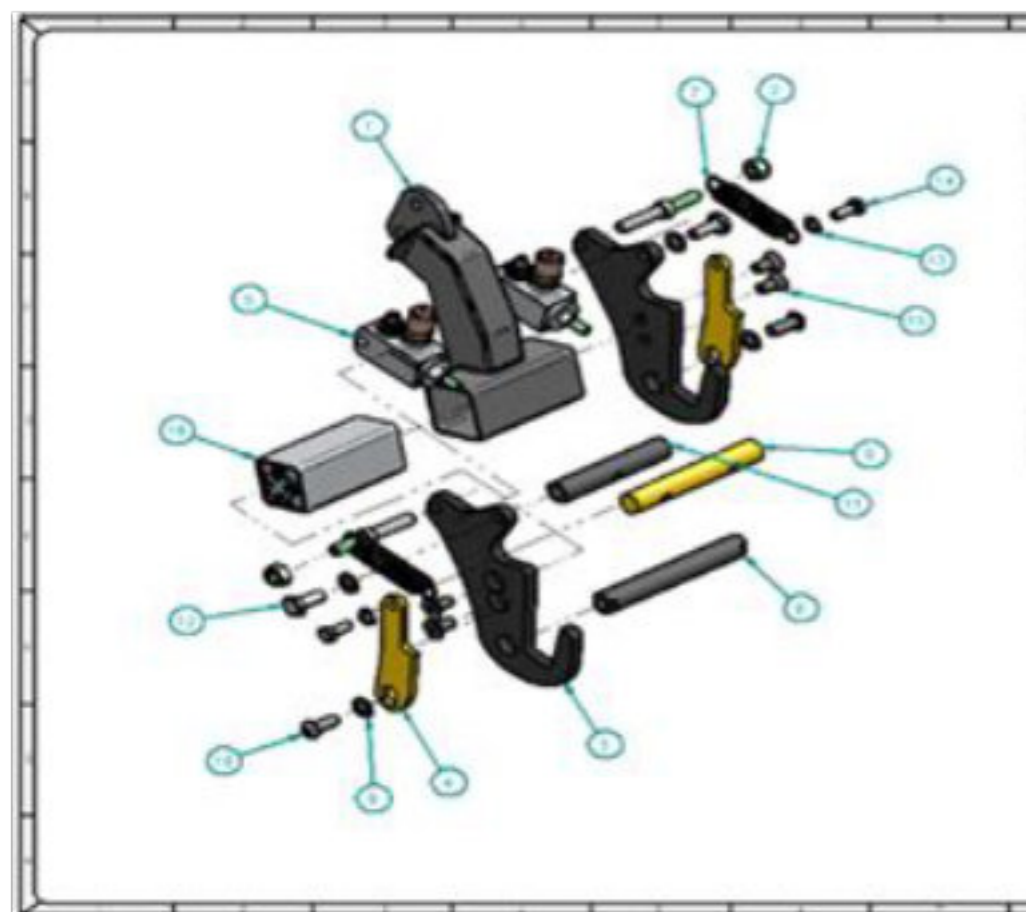

ID	DESCRIPTION	QTY	UNIT
1	FLANGE	1	PC
2	SCREW	2	PC
3	WASHER	2	PC
4	SPACER	1	PC
5	BEARING	2	PC
6	SHAFT	1	PC
7	GEAR	1	PC
8	KEY	1	PC
9	COUPLER	1	PC
10	HOUSING	1	PC

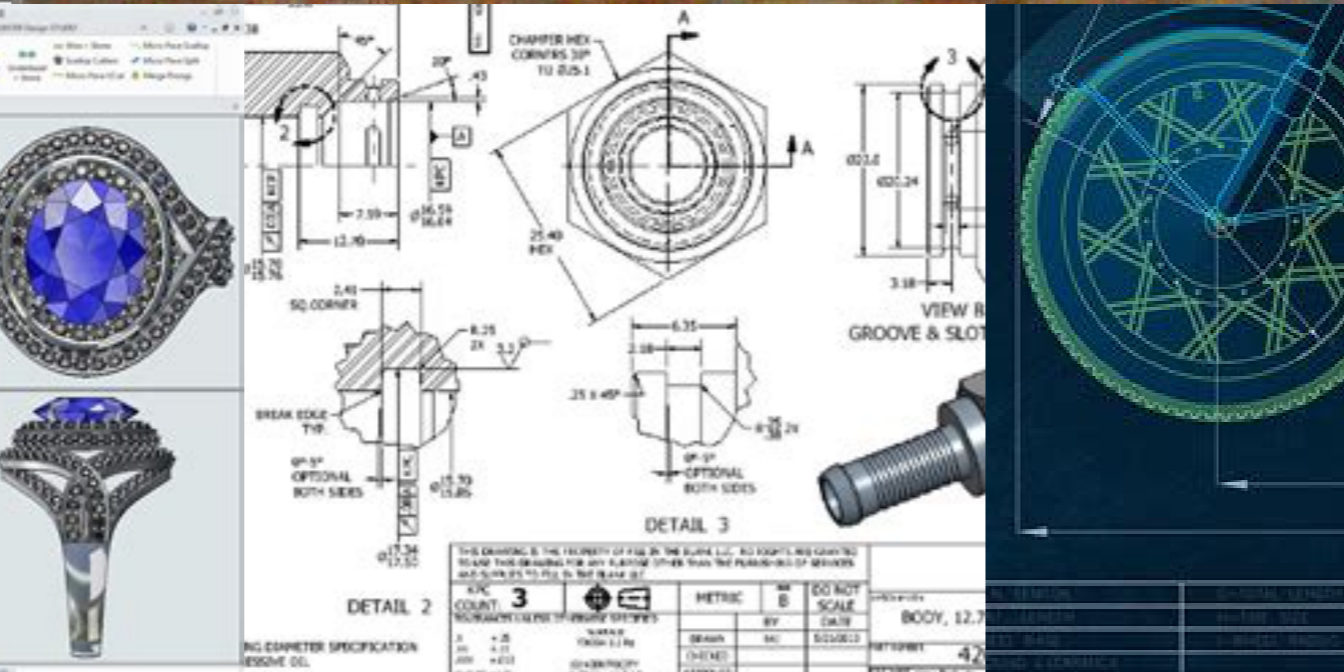
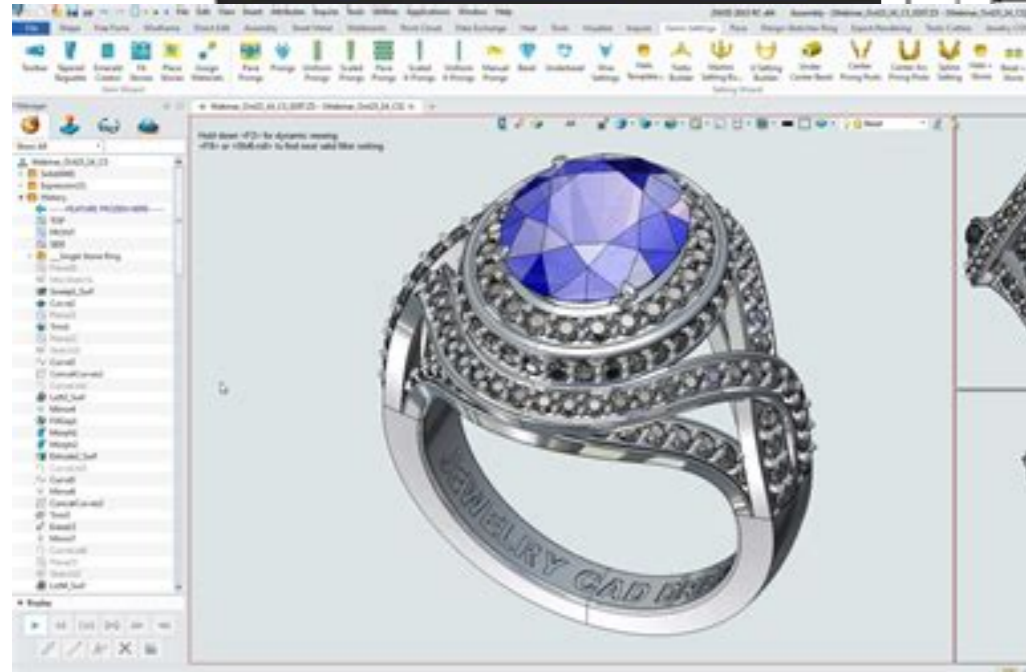
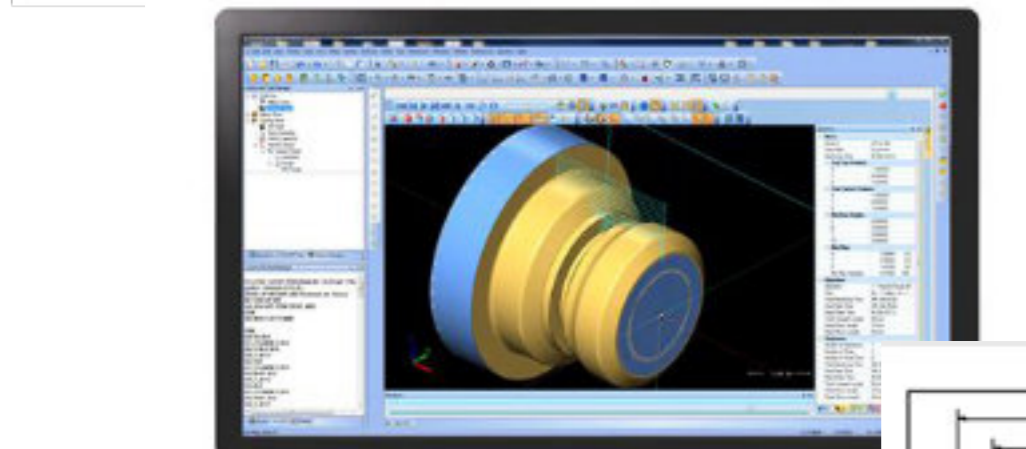
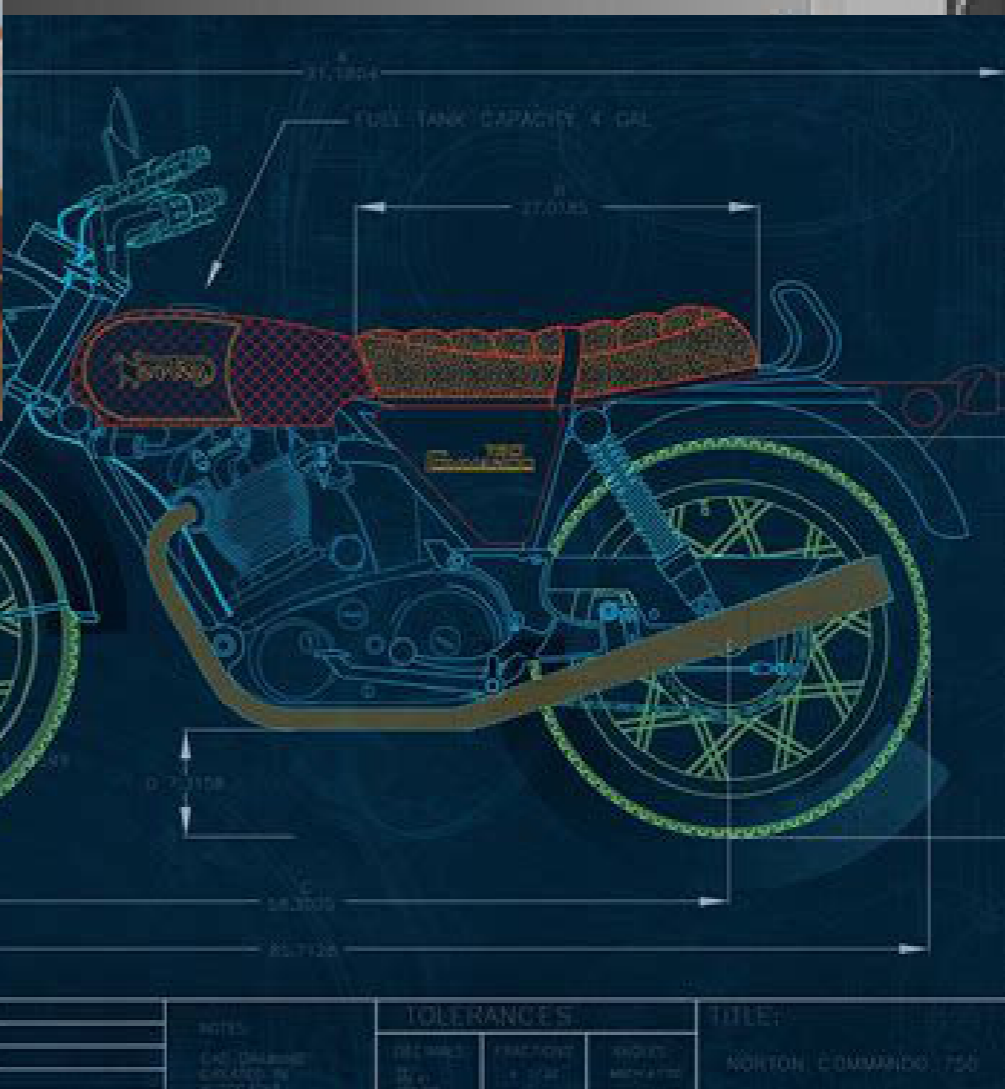
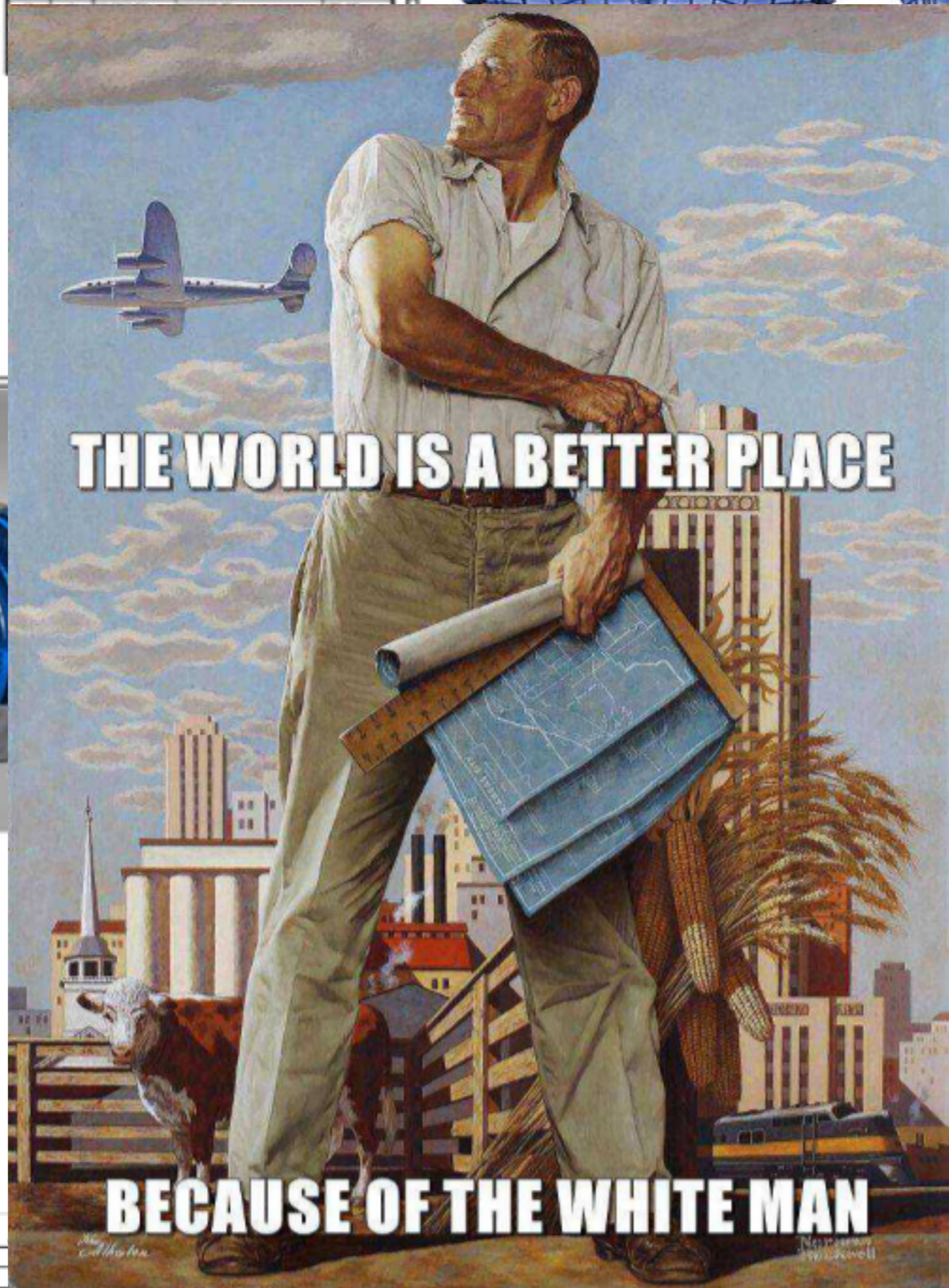
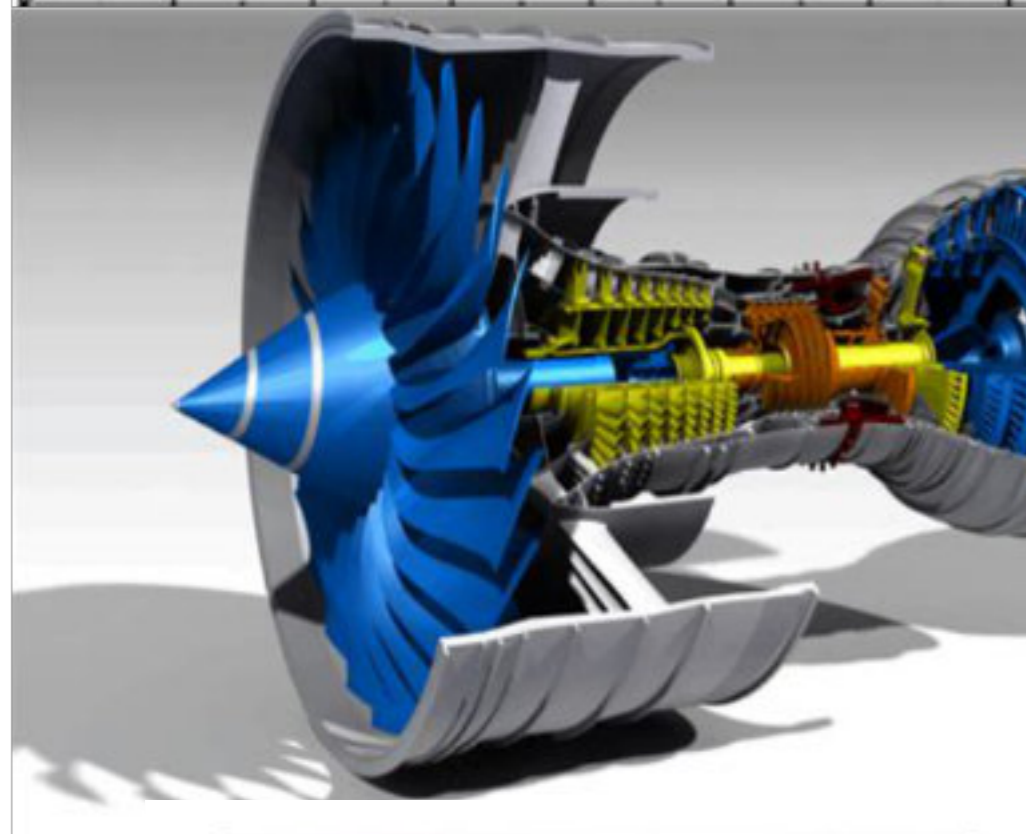
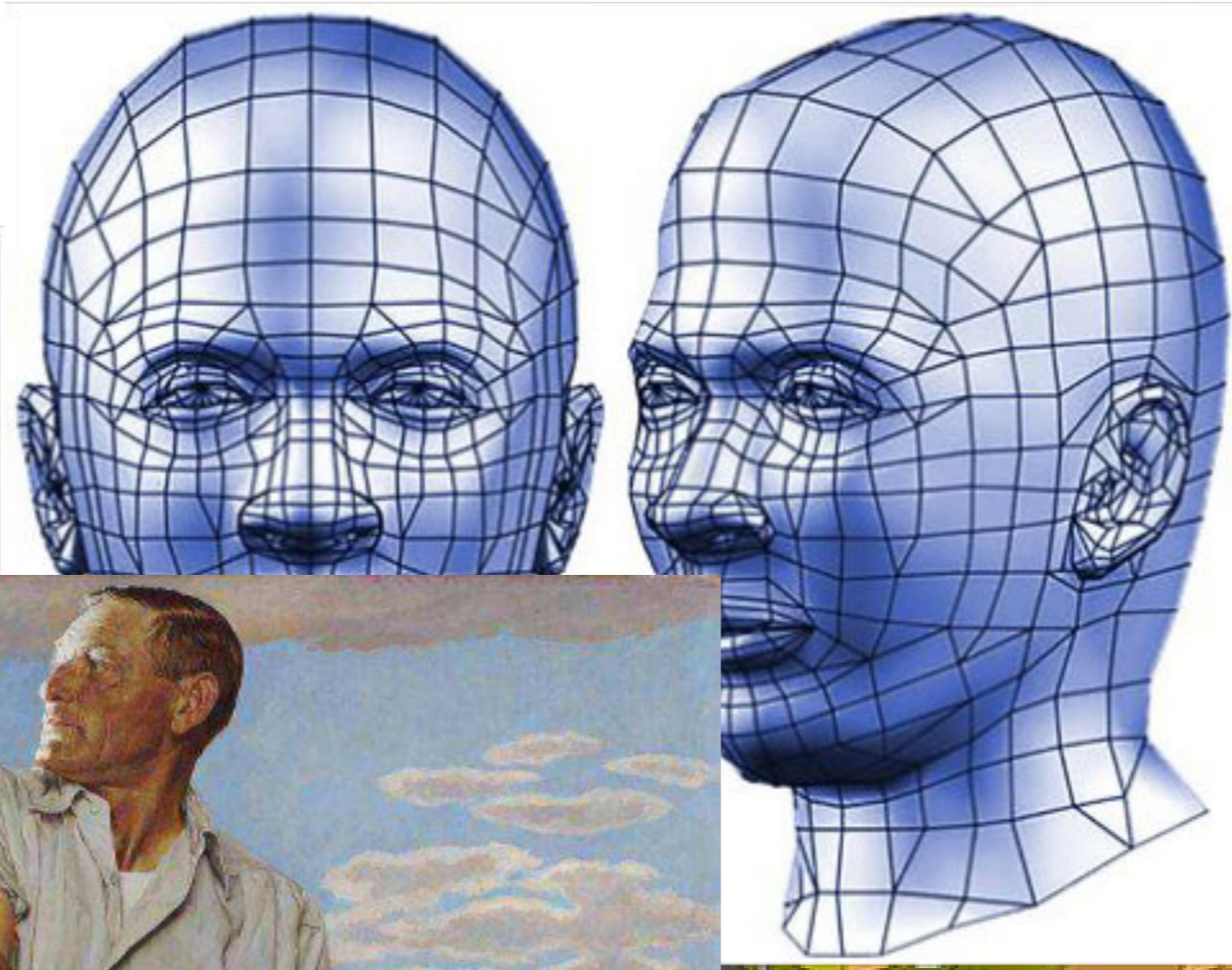



William Wilberforce
On Friday July 26th 1833 as he lay on his deathbed Wilberforce exclaimed: "Thank God that I have lived to witness the day in which England is willing to give £20 million for the abolishment of slavery." (What would that be worth today ?)
He died three days later.

The Slavery Abolition Bill 1833 passed through the House of Lords, it received the Royal Assent (which means it became law) on 29 August 1833 and came into force on 1 August 1834. On that date slavery was abolished throughout the vast British Empire. The Act automatically applied as new possessions (principally in Africa) subsequently became part of the British Empire.

To know who rules over you. Simply find out who it is that you are not allowed to criticise.Voltaire

We, as White people, have been GAGGED!! Then bullied, insulted, demonised, and provoked, until we object and complain. We then get called *dirty names* like Nazi, Racist, White Extremist, etc, etc.

Our weak & corrupt Lib/Lab/Con Politicians are the problem. As of Jan 2021, the UK elections are years away. Check out Populism, and Nationalism ASAP. Become "WHITE WOKE" & Push Back.
Do it today, NOW!

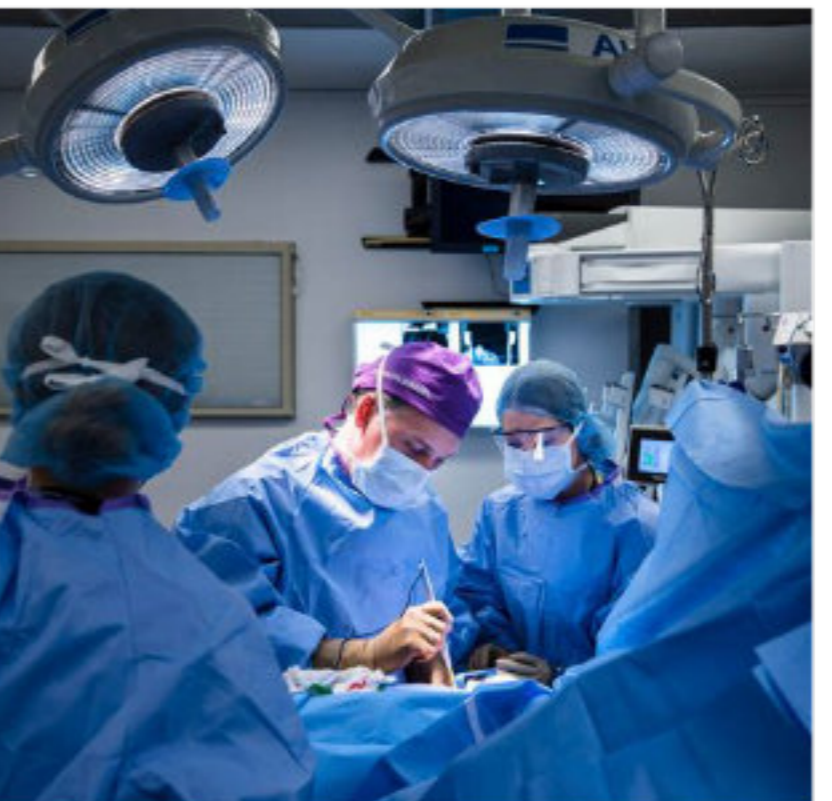



William Wilberforce

On Friday July 26th 1833 as he lay on his deathbed Wilberforce exclaimed: "Thank God that I have lived to witness the day in which England is willing to give £20 million for the abolishment of slavery." (What would that be worth today ?) He died three days later.

The Slavery Abolition Bill 1833 passed through the House of Lords, it received the Royal Assent (which means it became law) on 29 August 1833 and came into force on 1 August 1834. On that date slavery was abolished throughout the vast British Empire. The Act automatically applied as new possessions (principally in Africa) subsequently became part of the British Empire.

To know who rules over you. Simply find out who it is that you are not allowed to criticise.Voltaire

We, as White people, have been GAGGED!! Then bullied, insulted, demonised, and provoked, until we object and complain. We then get called *dirty names* like Nazi, Racist, White Extremist, etc, etc.

Our weak & corrupt Lib/Lab/Con Politicians are the problem. As of Jan 2021, the UK elections are years away. Check out Populism, and Nationalism ASAP. Become "WHITE WOKE" & Push Back.

Do it today, NOW!

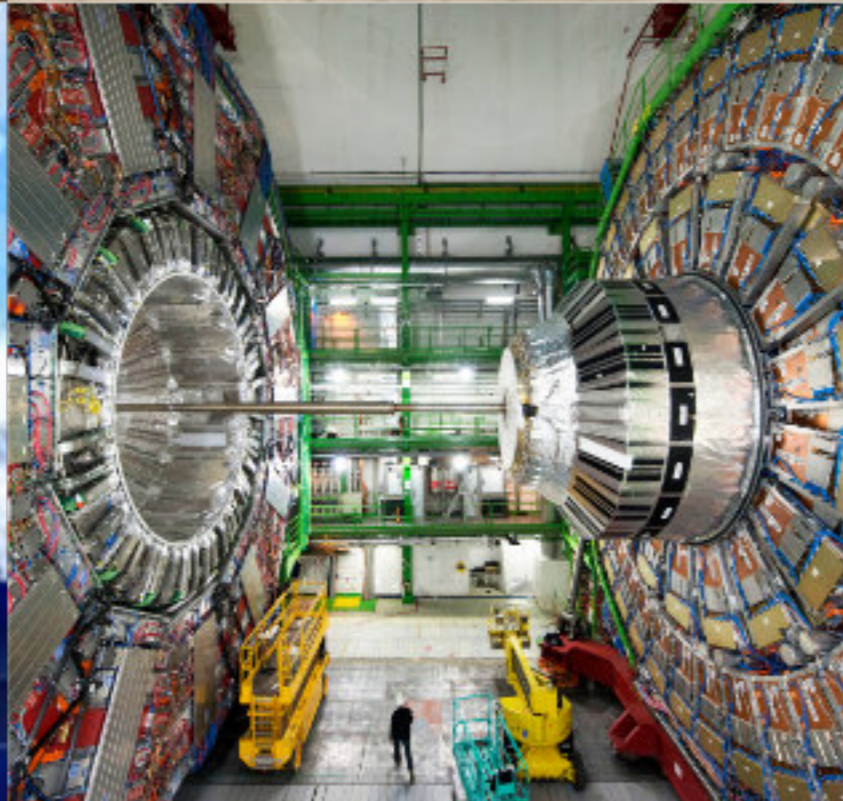



William Wilberforce

On Friday July 26th 1833 as he lay on his deathbed Wilberforce exclaimed: "Thank God that I have lived to witness the day in which England is willing to give £20 million for the abolishment of slavery." (What would that be worth today ?) He died three days later.

The Slavery Abolition Bill 1833 passed through the House of Lords, it received the Royal Assent (which means it became law) on 29 August 1833 and came into force on 1 August 1834. On that date slavery was abolished throughout the vast British Empire. The Act automatically applied as new possessions (principally in Africa) subsequently became part of the British Empire.

To know who rules over you. Simply find out who it is that you are not allowed to criticise.Voltaire

We, as White people, have been GAGGED!! Then bullied, insulted, demonised, and provoked, until we object and complain. We then get called *dirty names* like Nazi, Racist, White Extremist, etc, etc.

Our weak & corrupt Lib/Lab/Con Politicians are the problem. As of Jan 2021, the UK elections are years away. Check out Populism, and Nationalism ASAP. Become "WHITE WOKE" & Push Back.

Do it today, NOW!



William Wilberforce

On Friday July 26th 1833 as he lay on his deathbed Wilberforce exclaimed: "Thank God that I have lived to witness the day in which England is willing to give £20 million for the abolishment of slavery." (What would that be worth today ?) He died three days later.

The Slavery Abolition Bill 1833 passed through the House of Lords, it received the Royal Assent (which means it became law) on 29 August 1833 and came into force on 1 August 1834. On that date slavery was abolished throughout the vast British Empire. The Act automatically applied as new possessions (principally in Africa) subsequently became part of the British Empire.

To know who rules over you. Simply find out who it is that you are not allowed to criticise.Voltaire

We, as White people, have been GAGGED!! Then bullied, insulted, demonised, and provoked, until we object and complain. We then get called *dirty names* like Nazi, Racist, White Extremist, etc, etc.

Our weak & corrupt Lib/Lab/Con Politicians are the problem. As of Jan 2021, the UK elections are years away. Check out Populism, and Nationalism ASAP. Become "WHITE WOKE" & Push Back.

Do it today, NOW!





William Wilberforce

On Friday July 26th 1833 as he lay on his deathbed Wilberforce exclaimed: "Thank God that I have lived to witness the day in which England is willing to give £20 million for the abolishment of slavery." (What would that be worth today ?)

He died three days later.

The Slavery Abolition Bill 1833 passed through the House of Lords, it received the Royal Assent (which means it became law) on 29 August 1833 and came into force on 1 August 1834.

On that date slavery was abolished throughout the vast British Empire.

The Act automatically applied as new possessions (principally in Africa) subsequently became part of the British Empire.

To know who rules over you. Simply find out who it is that you are not allowed to criticise.

.....Voltaire

We, as White people, have been GAGGED!! Then bullied, insulted, demonised, and provoked, until we object and complain. We then get called *dirty names* like Nazi, Racist, White Extremist, etc, etc.

Our weak & corrupt Lib/Lab/Con Politicians are the problem. As of Jan 2021, the UK elections are years away. Check out Populism, and Nationalism ASAP. Become "WHITE WOKE" & Push Back.

Do it today, NOW!





William Wilberforce

On Friday July 26th 1833 as he lay on his deathbed Wilberforce exclaimed: "Thank God that I have lived to witness the day in which England is willing to give £20 million for the abolishment of slavery." (What would that be worth today ?) He died three days later.

The Slavery Abolition Bill 1833 passed through the House of Lords, it received the Royal Assent (which means it became law) on 29 August 1833 and came into force on 1 August 1834. On that date slavery was abolished throughout the vast British Empire. The Act automatically applied as new possessions (principally in Africa) subsequently became part of the British Empire.

To know who rules over you. Simply find out who it is that you are not allowed to criticise.Voltaire

We, as White people, have been GAGGED!! Then bullied, insulted, demonised, and provoked, until we object and complain. We then get called *dirty names* like Nazi, Racist, White Extremist, etc, etc.

Our weak & corrupt Lib/Lab/Con Politicians are the problem. As of Jan 2021, the UK elections are years away. Check out Populism, and Nationalism ASAP. Become "WHITE WOKE" & Push Back.

Do it today, NOW!





William Wilberforce
On Friday July 26th 1833 as he lay on his deathbed Wilberforce exclaimed: "Thank God that I have lived to witness the day in which England is willing to give £20 million for the abolishment of slavery." (What would that be worth today ?)
He died three days later.

The Slavery Abolition Bill 1833 passed through the House of Lords, it received the Royal Assent (which means it became law) on 29 August 1833 and came into force on 1 August 1834. On that date slavery was abolished throughout the vast British Empire. The Act automatically applied as new possessions (principally in Africa) subsequently became part of the British Empire.

To know who rules over you. Simply find out who it is that you are not allowed to criticise.Voltaire

We, as White people, have been GAGGED!! Then bullied, insulted, demonised, and provoked, until we object and complain. We then get called *dirty names* like Nazi, Racist, White Extremist, etc, etc.

Our weak & corrupt Lib/Lab/Con Politicians are the problem. As of Jan 2021, the UK elections are years away. Check out Populism, and Nationalism ASAP. Become "WHITE WOKE" & Push Back.

Do it today, NOW!



@WhiteMotivation

There is absolutely **NOTHING** wrong with Whites loving & supporting our own race.



@WhiteMotivation

Whites are a global minority. We have the right to protect and preserve our race. No more apologies.



@WhiteMotivation

A lot of Whites have been brainwashed and think it's wrong to love and support their own race. Don't be like them.

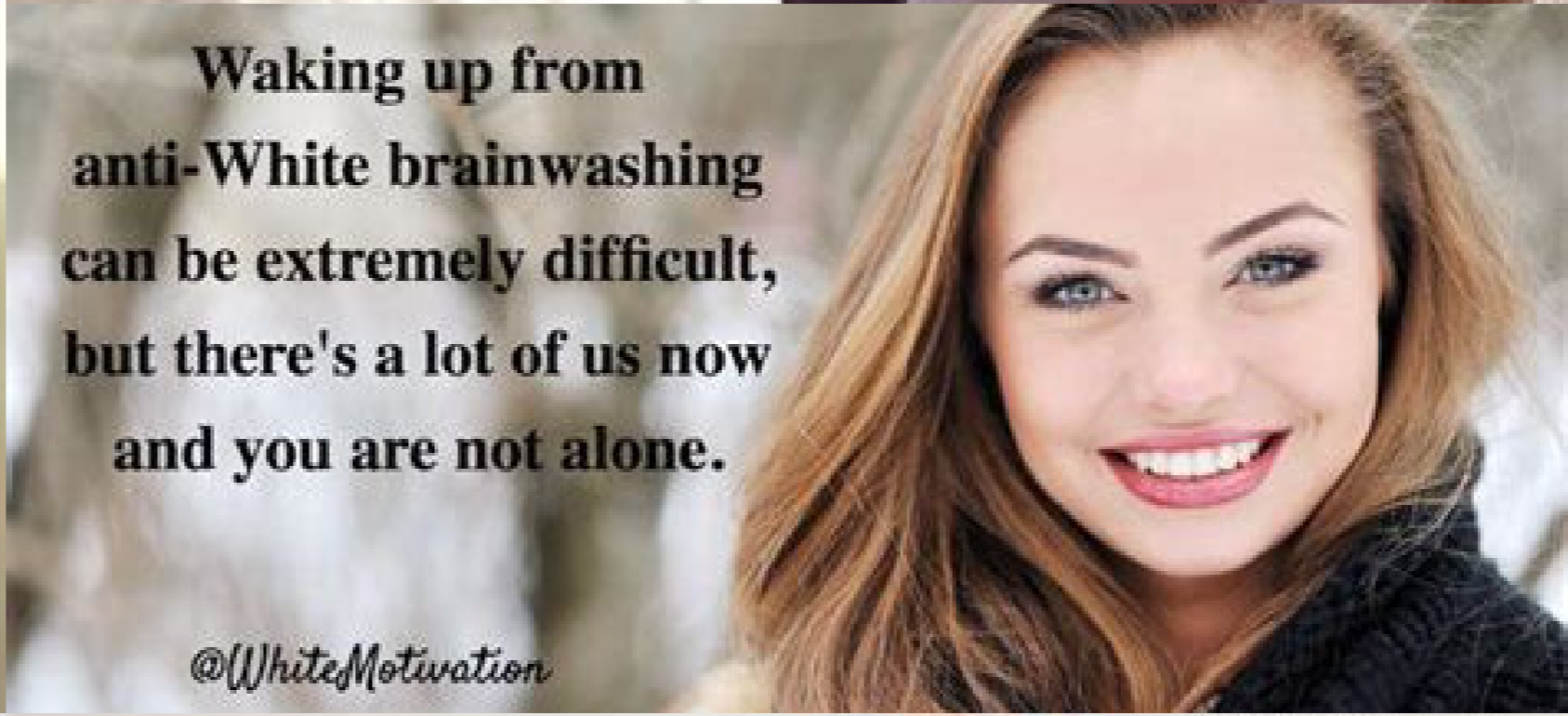

@WhiteMotivation

Waking up from anti-White brainwashing can be extremely difficult, but there's a lot of us now and you are not alone.



@WhiteMotivation

It's time for Whites to organize. We need to create legal and professional groups to help defend ourselves from anti-Whites and their constant hate based attacks. We need to connect with one another locally. We need to plan for our future and for the future of our children.



@WhiteMotivation

I love my White skin, my ancestors, my people, our history, accomplishments, and how absolutely amazing we are.

I have no guilt and I offer no apologies. I'm 100% proud of my Whiteness.

I love who I am.

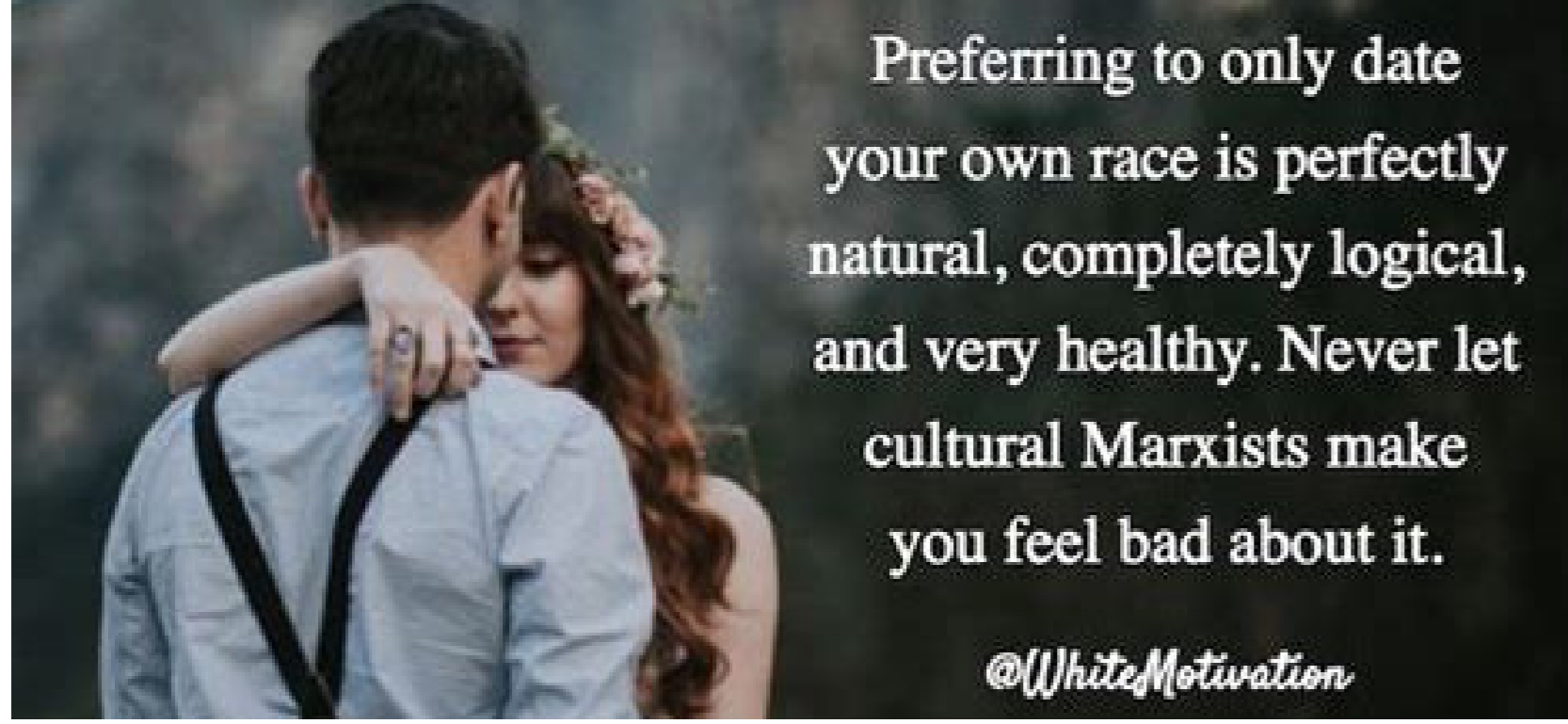

@WhiteMotivation

Preferring to only date your own race is perfectly natural, completely logical, and very healthy. Never let cultural Marxists make you feel bad about it.





William Wilberforce
On Friday July 26th 1833 as he lay on his deathbed Wilberforce exclaimed: "Thank God that I have lived to witness the day in which England is willing to give £20 million for the abolishment of slavery." (What would that be worth today ?)
He died three days later.

The Slavery Abolition Bill 1833 passed through the House of Lords, it received the Royal Assent (which means it became law) on 29 August 1833 and came into force on 1 August 1834. On that date slavery was abolished throughout the vast British Empire. The Act automatically applied as new possessions (principally in Africa) subsequently became part of the British Empire.

To know who rules over you. Simply find out who it is that you are not allowed to criticise.Voltaire

We, as White people, have been GAGGED!! Then bullied, insulted, demonised, and provoked, until we object and complain. We then get called *dirty names* like Nazi, Racist, White Extremist, etc, etc.

Our weak & corrupt Lib/Lab/Con Politicians are the problem. As of Jan 2021, the UK elections are years away. Check out Populism, and Nationalism ASAP. Become "WHITE WOKE" & Push Back. **Do it today, NOW!**

So! These People Don't Like Us Whites !!! *Are Badly Treated By Us ??? !!! - And Want To Get Rid Of Us ??? !!!*

You Retweeted

 **Martin Brooks**  #FreeSpeech #UK
@MJBr00ks58

If Britain is so inherently racist why do so many people of colour keep putting their lives at risk trying to enter our country by illegal means crossing the English Channel from France in unsuitable dinghies?

 **Vicky** @2tweetaboutit · 22h
Taxpayers Funded National Trust's BLM-Style Assault on British Heritage
breitbart.com/europe/2021/02... via @BreitbartNews

7:41 AM · Feb 4, 2021 · Twitter for Android

"Labour will put Black and ethnic families first to preserve a diverse nation"
Diane Abbott

 **Labour**
Hackney North and Stoke Newington.



"The problem in Britain is not immigration, the problem in Britain is WHITE people"
Diane Abbott, Labour MP

SUPPORTS DIVERSITY

EXCEPT DIVERSITY OF OPINION



WHITE LIVES MATTER



Kriss Donald 15 - Did Anyone Take The Knee ?

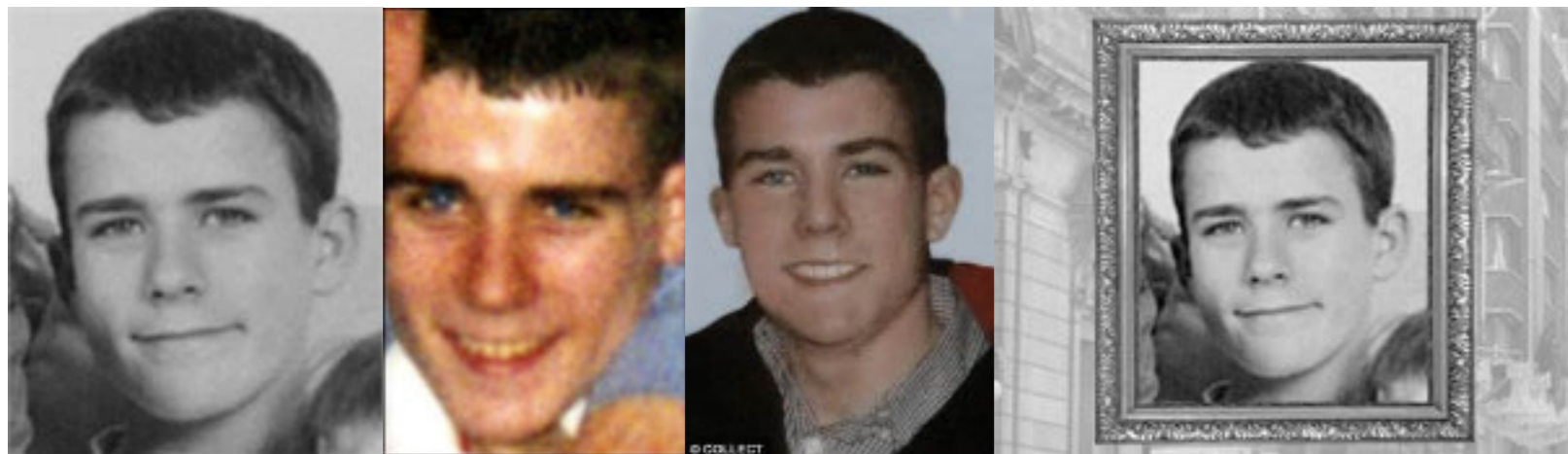

From British Nationalist, December 2004

15 YEAR OLD BOY BURNED ALIVE FOR BEING WHITE !

One Law for Them...Yet again!

Did you know that in Glasgow on 18th October, the first ever Scottish conviction for racially motivated murder was secured?

Did you read or hear about how fifteen year old Kriss Donald was attacked by Muslim Racists, abducted, driven around Scotland, beaten, mutilated, stabbed and burned alive?

Did you know that the first defendant accused admitted he was killed simply for being "a white boy"?

The chances are you did not if you do not log onto the BNP website or read Voice of Freedom regularly.

Shame on you if you do neither!

ON THE OTHER HAND,

Very few of you will be unaware of the 'heinous' attack on the coloured footballers playing for England by Spanish fans the day before.

Wall-to-wall national TV and press coverage was given over to the crime of

" name calling "

while one of the most vicious and brutal murders of a child ever witnessed in this country was either ignored or left as a regional filler.

This is more than politically correct meddling.

This is Communist style manipulation of public opinion.

Hide the real horrors and inflate lesser evils.

White people cannot be seen as victims, only as aggressors.

The truth will out though, thanks to the BNP and your help in spreading the word to friends and family.

Kenny Smith

Editor

I SHOULD HAVE KILLED MORE WHITE !*\$\$@S

Race-hate monster's sick rant in prison note



This is part of the article published on the Scotsman website.

"In a horrific account of his final moments, the jury was told Kriss was stabbed 13 times in a frenzied attack which severed one of his ribs, three arteries, one of his lungs, his liver and kidney.

He was then doused in petrol, set alight and left to die.

Evidence suggests Kriss made his way down towards the Clyde and tried to extinguish the flames by rolling around in a muddy hollow near the cycle path where he was discovered."

Forensic evidence was given by the coroner which stated that the teenager was still alive when he had petrol poured on him and was set on fire.

His naked and burned body was found the following morning by a man out walking his dog, who thought it was an animal carcass dumped in the park.

The murders of indigenous whites in Britain by immigrants allowed to settle in Britain without a democratic mandate via a referendum from the British people legitimising successive governments to allow them in, is the 'Institutional Racism' that we, the indigenous British people have suffered at the hands of the corrupt British State for decades.

The murders of Kriss Donald and Ross Parker and others would not have happened if successive British governments had not allowed mass immigration into Britain for the last fifty years.

This is the 'Institutional Racism' that impacts upon the indigenous white community that is never recognised nor is ever the subject of any public inquiries.

Whilst the C.R.E and other race relations groups hunt down the endless fey phantoms of 'Institutional Racism' against ethnic minorities, we the White indigenous folk of this land and the horrors we face at the hands of immigrants are ignored, vilified and forgotten.



William Wilberforce

On Friday July 26th 1833 as he lay on his deathbed Wilberforce exclaimed: "Thank God that I have lived to witness the day in which England is willing to give £20 million for the abolishment of slavery." (What would that be worth today ?)

He died three days later.

The Slavery Abolition Bill 1833 passed through the House of Lords, it received the Royal Assent (which means it became law) on 29 August 1833 and came into force on 1 August 1834. On that date slavery was abolished throughout the vast British Empire.

The Act automatically applied as new possessions (principally in Africa) subsequently became part of the British Empire.

To know who rules over you. Simply find out who it is that you are not allowed to criticise.Voltaire

We, as White people, have been GAGGED!! Then bullied, insulted, demonised, and provoked, until we object and complain. We then get called *dirty names* like Nazi, Racist, White Extremist, etc, etc.

Our weak & corrupt Lib/Lab/Con Politicians are the problem. As of Jan 2021, the UK elections are years away. Check out Populism, and Nationalism ASAP. Become "WHITE WOKE" & Push Back.

Do it today, NOW!

Daanish Zahid Imran Shahid, Zeeshan Shahid
Mohammed Faisal Mustaq, Zahid Mohammed,



STABBED TO DEATH ON MARCH 14, 2004
R.I.P. Kriss Donald



Sajid Zulfiqar, 25, Zahid Bashir, 23, and Imran Maqsood, 21.
Asian gang members who boasted they had killed a white man
have been found guilty of murder.
NOT TREATED AS A RACE CRIME !



Christopher Yates 30.
Dead !
Every bone in his face
was broken.

There are many many more White victims of Racial Violence and Murder, that are either unreported or under reported.
Why do you think that might be ?
And who is responsible ?
Get involved with some of the Populist and Nationalist organisations and parties today.
Do it now.
Don't wait until election time!
Make contact with some of these people ASAP.

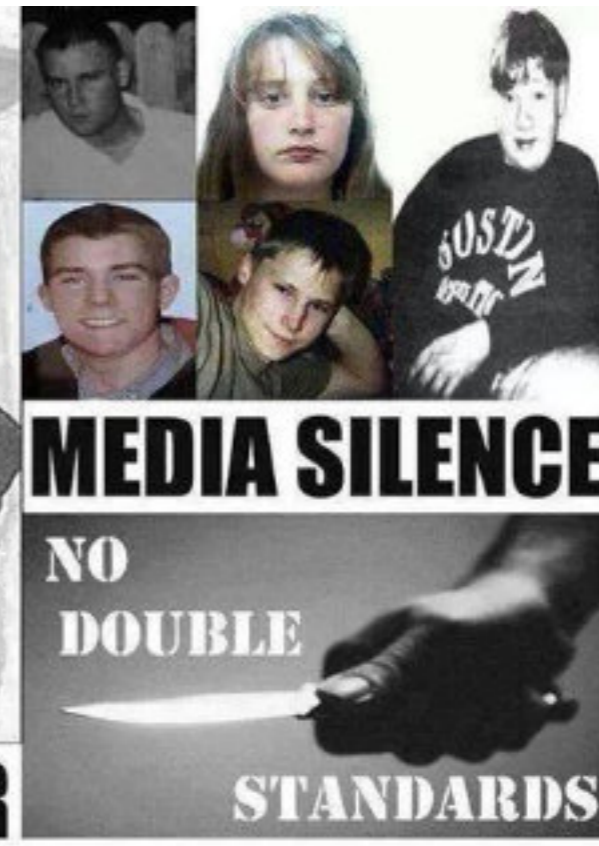

Rape victim.
Austrian tourist Alexandra Sablatnig.

They (8 OF THEM !) attacked her.
Chanting "FUCK THE WHITE BITCH"

Kicked and punched her.
Stripped her naked then raped her repeatedly.
Then they threw her into a canal and left her for dead !

There were 'Female' members in this gang who assisted the rape by pulling the victims legs apart !

The brutes, just 14 to 17 at the time, snatched pretty mother of two Alexandra Sablatnig when she strayed into the red-light district of King's Cross in September 1996.
They attacked her chanting "FUCK the white bitch," kicked and punched her, stripped her naked then raped her repeatedly.



William Wilberforce
On Friday July 26th 1833 as he lay on his deathbed Wilberforce exclaimed: "Thank God that I have lived to witness the day in which England is willing to give £20 million for the abolishment of slavery." (What would that be worth today ?)
He died three days later.

The Slavery Abolition Bill 1833 passed through the House of Lords, it received the Royal Assent (which means it became law) on 29 August 1833 and came into force on 1 August 1834. On that date slavery was abolished throughout the vast British Empire.
The Act automatically applied as new possessions (principally in Africa) subsequently became part of the British Empire.

To know who rules over you.
Simply find out who it is that you are not allowed to criticise.
.....Voltaire

We, as White people, have been GAGGED!! Then bullied, insulted, demonised, and provoked, until we object and complain. We then get called *dirty names* like Nazi, Racist, White Extremist, etc, etc.

Our weak & corrupt Lib/Lab/Con Politicians are the problem. As of Jan 2021, the UK elections are years away. Check out Populism, and Nationalism ASAP. Become "WHITE WOKE" & Push Back.
Do it today, NOW!



William Wilberforce
 On Friday July 26th 1833 as he lay on his deathbed Wilberforce exclaimed: "Thank God that I have lived to witness the day in which England is willing to give £20 million for the abolishment of slavery." (What would that be worth today?)
 He died three days later.

The Slavery Abolition Bill 1833 passed through the House of Lords, it received the Royal Assent (which means it became law) on 29 August 1833 and came into force on 1 August 1834. On that date slavery was abolished throughout the vast British Empire. The Act automatically applied as new possessions (principally in Africa) subsequently became part of the British Empire.

To know who rules over you. Simply find out who it is that you are not allowed to criticise.Voltaire

We, as White people, have been GAGGED!! Then bullied, insulted, demonised, and provoked, until we object and complain. We then get called *dirty names* like Nazi, Racist, White Extremist, etc, etc.

Our weak & corrupt Lib/Lab/Con Politicians are the problem. As of Jan 2021, the UK elections are years away. Check out Populism, and Nationalism ASAP. Become "WHITE WOKE" & Push Back. **Do it today, NOW!**



10 August 2017
SARAH CHAMPION
British Pakistani men ARE raping and exploiting white girls... and it's time we faced up to it
 Labour MP for Rotherham and Shadow Secretary of State for Women and Equalities comments on a horrific trend in grooming and sexual abuse by gangs.

Asian gangs' 1,400 child sex victims in one town
 Social workers too scared of being branded racist to act
 by DOMINIC YEATMAN
 FEAR of being branded racist allowed 16 years of 'grooming' sexual abuse by Asian gangs of at least 1,400 children to go uncurbed, an inquiry found. Council officials 'applied' around the fact that 'by far the majority' of the victims - who were as young as 11 - were white, according to the Rotherham Abuse Inquiry. The girls were groomed, abused in parks and abandoned with handguns by groups of men, before being ignored by the council and treated with 'contempt' by the police. Prof Alex Lee who headed the inquiry into the attacks between 1997 and 2013 in South Yorkshire, said: 'It is hard to describe the appalling nature of the abuse that child victims suffered. They were raped by multiple perpetrators, trafficked to other towns and cities and abandoned in parks and streets. TURN TO PAGE 6 >>>



Notifications

  Naz Shah MP liked your reply
 Exactly Areeq, those abused girls in Rotherham and elsewhere just need to shut their mouths. For the good of #diversity!

  Labour Politics Zone and Naz Shah MP Retweeted your Tweet
 Exactly Areeq, those abused girls in Rotherham and elsewhere just need to shut their mouths. For the good of #diversity!
[Show all](#)

Asian gangs, schoolgirls and a sinister taboo
Daily Mail, November 2012

Sex predators who held city in terror are jailed
From Saturday's Mail



Muslim is spared jail over sex with a 13-year-old girl

By Paul Bentley

A MUSLIM who raped a 13-year-old girl he groomed on Facebook has been spared a prison sentence after a judge heard he went to an Islamic faith school where he was taught that women are worthless.

Adil Rashid, 18, claimed he was not aware that it was illegal for him to have sex with the girl because his education left him ignorant of British law.

Yesterday Judge Michael Stokes handed him a suspended sentence, saying: "Although chronologically 18, it is quite clear from the reports that you are very naive and immature when it comes to sexual matters."

Earlier Nottingham Crown Court heard that such crimes usually result in a four to seven-year prison sentence.

But the judge said that because Rashid was "passive" and "lacking assertiveness", sending him to jail might cause him "more damage than good".

Rashid, from Birmingham, admitted he had sex with the girl, saying he had been "tempted by her" after they met online.

They initially exchanged messages on Facebook before sending texts and chatting on the phone over a two-month period. They then met up in Nottingham.



Adil Rashid: 'Naive and immature'

where Rashid had booked a room at a Premier Inn.

The girl told police they stayed at the hotel for two hours and had sex after Rashid went to the bathroom and emerged wearing a condom. Rashid then returned home and went straight to a mosque to pray.

He was arrested the following week after the girl confessed what had happened to a school friend, who informed a teacher.

He told police he knew the girl was 13 but said he was initially reluctant to have

sex, before relenting after being seduced. Earlier the court heard Rashid had 'little experience of women' due to his education at an Islamic school in the UK, which cannot be named for legal reasons.

After his arrest, he told a psychologist he did not know having sex with a 13-year-old was against the law.

In other interviews with psychologists, Rashid claimed he had been taught in his school that 'women are no more worthy than a lollipop that has been dropped on the ground'.

When Judge Stokes said Rashid 'must have known it was illegal, unless he was going round with his eyes shut', defence lawyer Laban Leake said reports suggested Rashid had a 'degree of sexual naivety'.

"The school he attended, it is not going too far to say, can be described as a closed community and on this occasion this was perpetuated by his home life."

"It is not too far to say that he may not have known that having sex with a 13-year-old girl was illegal."

Judge Stokes sentenced Rashid to nine months' youth custody, suspended for two years, along with a two-year probation supervision order.

He said Rashid had an 'unusual education', adding: 'Comparing women to lollipops is a very curious way of teaching young men about sex.'

HOW MAIL FOLLOWED THE STORY



in Cryer: Call for action

BETRAYED BY THE PC BRIGADE
 From the Mail writer who first revealed the scandal of Muslim sex gangs, a damning exposé of how politically correct police and social workers betray!

WHY DID NO ONE LISTEN TO TEENAGE VICTIM OF SEX GANG?
 As nine men face jail for grooming girls...

Mail, Sept 28 2012 ... *May 9 2012*

Jailed, Asian sex gang who preyed on schoolgirls as young as twelve
 ... *November 6, 2012*

"I don't like them! ('white guys') I want them to be the lost species in a hundred years!"



Yasmin Alibhai Brown said this on the 4 June 2006 edition of 'Dateline London.'

No BBC executive, politician, journalist, judge or policeman ever accused her of 'racism.' Nor was she ever prosecuted for wanting the white race disappeared.

Taxi drivers ferried girls from school gates

THERE were numerous examples of girls being picked up from school gates in taxis and taken away to be sexually abused by men – often in the back of the cars. Taxis also collected abuse victims from residential care homes, with girls taken on the 'longest and darkest route home' as the driver quickly turned the subject of conversation to sex. Despite warnings by schools that this was happening, no action was taken by the licensing authority to clamp down on the role of taxi drivers in the systematic abuse. There was a sense of 'exasperation' and 'hopelessness' among some

professionals at being unable to disrupt their activity, the report said. Strategy meetings about one taxi firm had been held on four occasions in seven weeks. The minutes of one meeting detailed ten girls and young women – three of whom were involved in separate instances of abduction by taxi drivers. Seven of the girls claimed they were being abused in return for 'free taxi rides and goods'. There are around 1,300 licensed taxi drivers in Rotherham and the local authority had not suspended or revoked the licence of any of them in the interests of public safety.

The Telegraph

Rochdale grooming trial: Police accused of fail investigate paedophile gang for fear of appearing racist



Muslim grooming gangs are still a problem in the UK.

The Government still won't address the problem.

We cannot keep avoiding the truth.

"Between April 2017 and March 2018 the police recorded over 16,000 cases of rape of children under the age of 16 in England and Wales. Ministry of Justice statistics over the same period suggest that few of these rapes resulted in a criminal conviction" (Baroness Cox, House of Lords Hansard, 2019).

Why is the Government still ignoring this issue?

British authorities have deliberately ignored this issue for decades despite this being well known by politicians and law enforcement agencies for some time. This is because of the obvious fact that the members of these 'grooming gangs' are overwhelmingly Muslim. Apparently, protecting the idea that Muslims are wonderful, peaceful people is more important than protecting our children from being tortured and raped by them. We must continue to make our voices heard on this issue and let the government know that we will not just 'ignore' the problem like they so desperately want us to.



(Above) Members of convicted grooming gangs that just happen to be majority Muslim.. by coincidence?



William Wilberforce
 On Friday July 26th 1833 as he lay on his deathbed Wilberforce exclaimed: "Thank God that I have lived to witness the day in which England is willing to give £20 million for the abolishment of slavery." (What would that be worth today ?)
 He died three days later.

The Slavery Abolition Bill 1833 passed through the House of Lords, it received the Royal Assent (which means it became law) on 29 August 1833 and came into force on 1 August 1834. On that date slavery was abolished throughout the vast British Empire. The Act automatically applied as new possessions (principally in Africa) subsequently became part of the British Empire.

To know who rules over you. Simply find out who it is that you are not allowed to criticise.Voltaire

We, as White people, have been GAGGED!! Then bullied, insulted, demonised, and provoked, until we object and complain. We then get called *dirty names* like Nazi, Racist, White Extremist, etc, etc.

Our weak & corrupt Lib/Lab/Con Politicians are the problem. As of Jan 2021, the UK elections are years away. Check out Populism, and Nationalism ASAP. Become "WHITE WOKE" & Push Back. **Do it today, NOW!**

JUSTICE FOR CHARLENE!

Charlene Downes vanished 11 years ago on 1st November 2003.



She had been 'groomed' by the Muslim owners of several Blackpool takeaways. Police believe she was raped and murdered. Despite the two main suspects being recorded boasting about how they raped and stabbed Charlene to death, the Crown Prosecution Service refused to order a retrial when the case collapsed on a technicality.

So Charlene's family still wait for justice and the message goes out to other paedophile grooming gangs – young English girls are easy meat and the Powers That Be just don't care.

That's why we're out today – because **WE DO CARE!**

That's why we're demanding:

- RE-TRIAL FOR CHARLENE'S ALLEGED KILLERS
- PUBLIC INQUIRY into the 30-year FAILURE by Britain's POLICE to deal with grooming gangs
- The SACKING of all Police, Council and Education Authority leaders who were part of the systematic failure. And the REMOVAL OF PENSION RIGHTS for the guilty ones who have already retired.
- DEPORTATION of all convicted groomers once they've served their prison sentences.

Local BLACKPOOL Contact - 07958656633
 Printed & Published by Proton, PO Box 44, Widdpool, S72 0WE

ESTABLISHMENT PAEDOPHILE COVER-UP

The police ignored Muslim grooming gangs. The media wouldn't report the scandal. The Crown Prosecution Service and councils persecuted the brave few who spoke out. The politicians told us to 'celebrate' mass immigration and turned a blind eye to more paedo monsters in their midst.

Between them, they let down thousands of innocent victims. And now they're trying to cover it up!



The first head of the inquiry, Elizabeth Butler Schloss, was the SISTER of the Attorney General who was responsible for so many non-prosecutions of paedophiles in the 1990s. But outraged abuse victims forced her to resign.

Cameron then appointed Fiona Woolf – Lord Mayor of London and a well-heeled close friend of Leon Brittan, who was Home Secretary when some of the worst abuse was covered up AND who was named in Parliament as being involved in child sexual abuse himself. Victims' anger forced HER to resign yesterday.

We need a proper, truly INDEPENDENT PUBLIC INQUIRY. Run by an INDEPENDENT EXPERT JUDGE with no links to Britain's paedophile-riddled Establishment. We propose a Judge from Canada or Australia.

Next is to break the Politically Correct taboo against admitting the clear link between on-street grooming and the warped cultural and religious attitudes that dominate Britain's Pakistani Muslim community.

We're not saying that all Muslims are grooming perverts, but it's a FACT that the vast majority of the gangs are Muslim. Only when this is ADMITTED can the problem be SORTED OUT!

Calls for sex inquiry chief to quit over her dinners with Brittan
 OOPS! SILLY ME!
 We'll boycott child abuse investigation, warn the victims

RESTS MADE AND ROCHDALE COMING CASE

After eight men were jailed for a total of 77 years for sexually abusing young girls, more are arrested for child grooming

vealed: consequences on UK

THEY SAID THEY'D BURN MY BROTHER ALIVE IF I DIDN'T GIVE IN TO DEMANDS

ONE victim told her mother 'I may as well be dead' after suffering months of alleged violent sexual abuse at the hands of the gang.

The Old Bailey heard how the girl had been 'sweet and innocent' before she began to go off the rails aged 12, playing truant and smoking cannabis with boys.

She was allegedly spotted as 'an ideal target' by three of the defendants, who bought her perfume and supplied her with cannabis and cocaine before demanding sex.

By the time she was 13, she was being sold for sex with strangers, disappearing from home for days at a time.

The girl said the gang told her they would set fire to her home and burn her brother alive unless she agreed to sex. And she

became so enslaved to her abusers that she 'forgot' it was her 15th birthday when she was with them, the Old Bailey heard.

She told police of the 'pack mentality', with each man encouraging the others.

Noel Lucas QC, prosecuting, said: 'She saw other drugged and emaciated girls in houses, sometimes just lying on a bed with their legs drawn up and completely out of it, waiting for the next round of drink and drugs.'

'If she resisted or tried to fight back they would slap her, grab her hair and force her to lie down, even if she was crying.'

'It got to the stage where she just got wasted and let them get on with it for fear of getting a kicking.'

At one point she tried to avoid

sex by saying she had her period but one of the accused, Akhtar Dogar, found out she was lying.

She was allegedly driven to a nearby wood where the gang told her: 'You know what we do with pigs, slit their throats,' and threatened to 'cut her head off'.

She was then allegedly forced to perform a sex act on a gang of men before being abandoned.

Unable to find her way home, she was eventually forced to call her alleged abusers and beg them to collect her.

Evidence from her mother was read to the court in which she said her daughter told her she was self-harming because 'it takes away the hurt'.

The girl called this period a 'living hell' and said the men made her 'feel she was the guilty one'.



KEIGHTLY AYLESBURY BANBURY



ACCRINGTON CANTERBURY COVENTRY

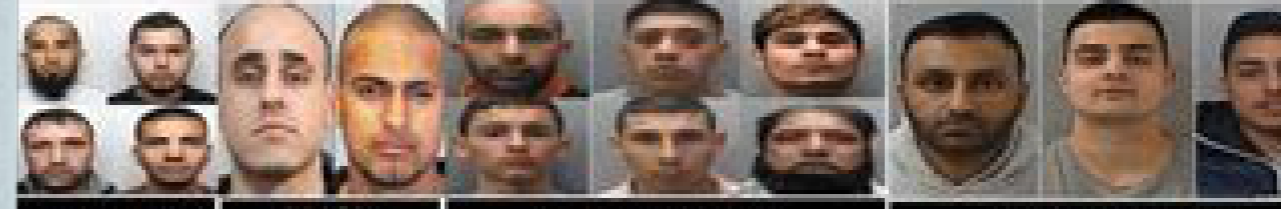

DEWSBURY DERBY PETERBOROUGH MIDDLESBROUGH



BRISTOL HUDDERSFIELD



ACCRINGTON CANTERBURY COVENTRY



ACCRINGTON CANTERBURY COVENTRY

UP TO 100 VICTIMS PLIED WITH DRINK AND RAPED

A GANG of 'sexual predators' cruised the streets of Derby for predominantly white girls as young as 12 who were plied with drink and drugs and raped or abused.

Up to 100 'vulnerable' girls may have been groomed, abused or supplied cocaine by married fathers Abid Saddique and Mohammed Liaqat and their friends.

A court heard the pair used Liaqat's BMW saloon to trawl for victims, pulling up alongside girls outside shops or schools and chatting them up before a 'campaign of calls and texts' to groom them.

Saddique, 27, and Liaqat, 28, gave the victims - most from

Asian gangs, schoolgirls and a sinister taboo...

Daily Mail, November 27, 2010

broken homes - vodka and cocaine before taking them to 'parties' in hotels or flats with other gang members to rape or degrade them. When girls refused their advances they

were threatened with hammers or thrown out of cars.

Saddique and Liaqat, each British-born and of Pakistani origin with an arranged marriage, were found guilty in November at Leicester Crown Court of a catalogue of sexual abuse over an 18-month period. They await sentence.

Seven other guilty members of the Derby-based gang have already been jailed. Five, all but one of them Asian, were given sentences ranging from two years, ten months to seven-and-a-half years for sex and drugs offences. Two others, both Asian, pleaded guilty to perverting the course of justice and were both jailed for 18 months.

BRISTOL HUDDERSFIELD

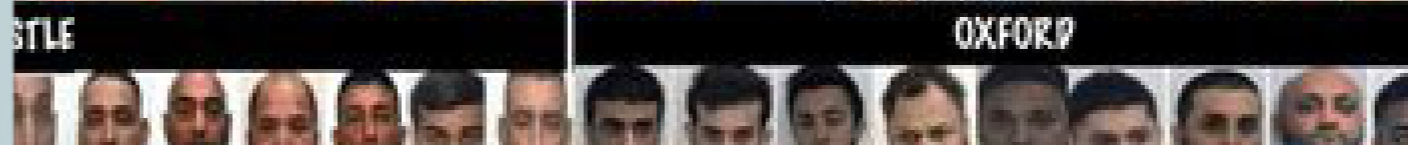
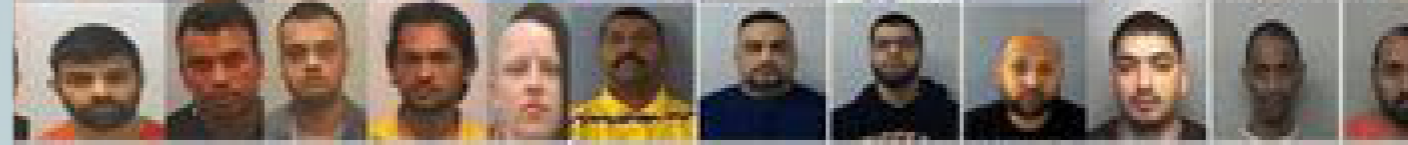

ACCRINGTON CANTERBURY COVENTRY

FOR THE VICTIMS OF GROOMING!

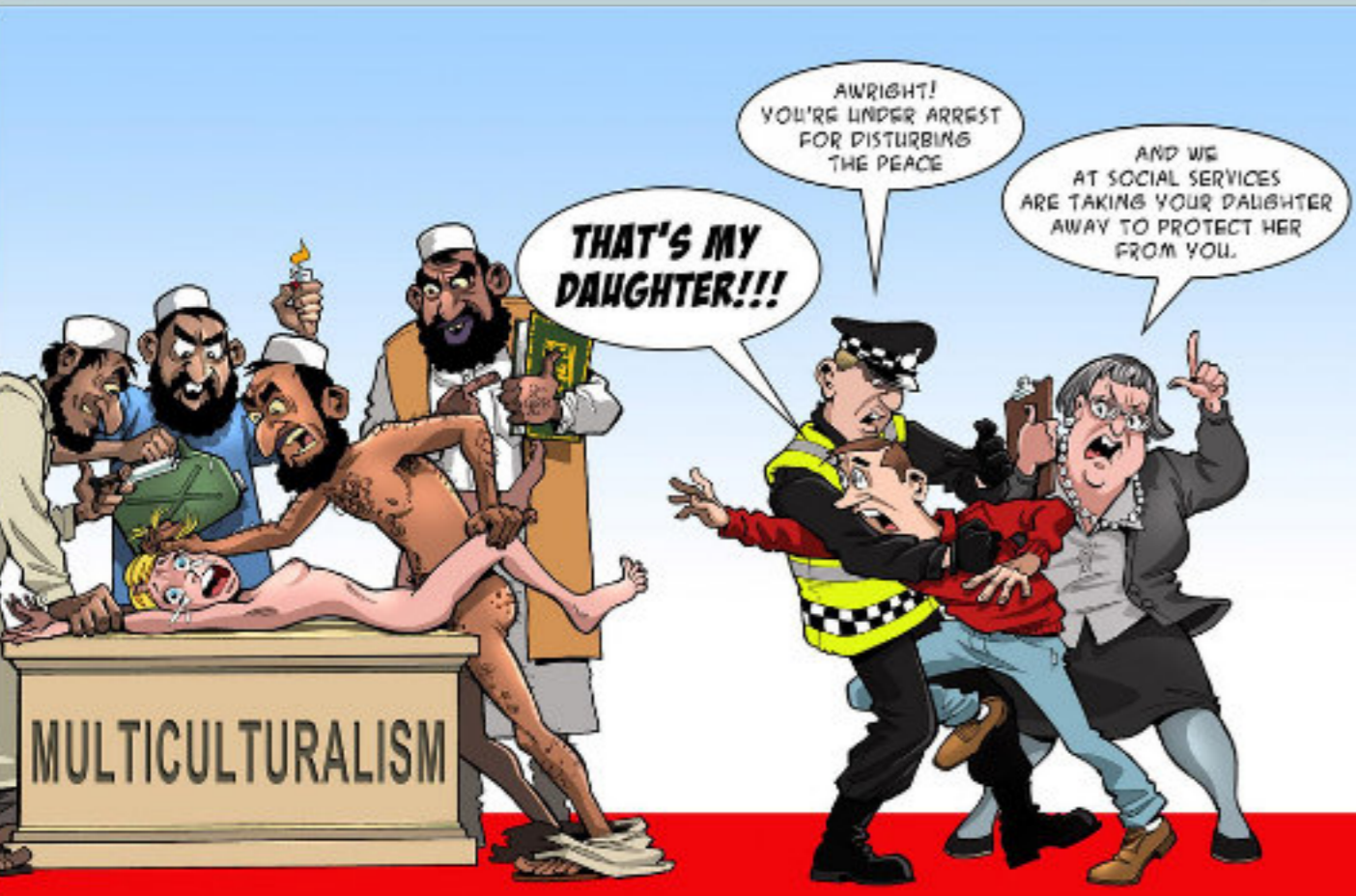

William Wilberforce

On Friday July 26th 1833 as he lay on his deathbed Wilberforce exclaimed: "Thank God that I have lived to witness the day in which England is willing to give £20 million for the abolishment of slavery." (What would that be worth today?)

He died three days later.

The Slavery Abolition Bill 1833 passed through the House of Lords, it received the Royal Assent (which means it became law) on 29 August 1833 and came into force on 1 August 1834.

On that date slavery was abolished throughout the vast British Empire.

The Act automatically applied as new possessions (principally in Africa) subsequently became part of the British Empire.

To know who rules over you. Simply find out who it is that you are not allowed to criticise.Voltaire

We, as White people, have been GAGGED!! Then bullied, insulted, demonised, and provoked, until we object and complain. We then get called *dirty names* like Nazi, Racist, White Extremist, etc, etc.

Our weak & corrupt Lib/Lab/Con Politicians are the problem. As of Jan 2021, the UK elections are years away. Check out Populism, and Nationalism ASAP. Become "WHITE WOKE" & Push Back.

Do it today, NOW!

Shaun Bailey - The Man Who Would Be Mayor



Mr Shaun Bailey.

The Conservative candidate for the post of Mayor of London. In the 2021 London elections on 6th May.

Mr Bailey is just one more 'Victimhood Parasite'

I believe he will do all that he can if elected to the post of London Mayor, to justify 'Victim Points' against White people, for the benefit of Non Whites.

This will be on any old half baked absurd justification, that a Non White can dream up against us. It's been going on for years already.

With Mr Bailey in power as Mayor. It will be 'Black Privilege' on Steroids !

Marxist Generals - Ethnic Soldiers - White Victims - Worldwide



Shaun Bailey Sky News: Saturday 6 June 2020 12:25, UK

George Floyd death: Black Lives Matter protests 'absolutely need to go ahead', says Shaun Bailey.

Shaun Bailey, the Conservative candidate for London mayor, has contradicted the health secretary on the issue of protests.

Breaking up protests over the death of George Floyd to maintain social distancing guidance risk "bottling up" tension that may lead to violence, London mayoral candidate Shaun Bailey has said.

Thousands of Black Lives Matter activists have gathered in the capital this week to demonstrate, and many are expected to defy pleas from Health Secretary Matt Hancock with more mass gatherings across the weekend.

EDIT: Mr Bailey should educate BLM about the true history of the slave trade. Then BLM might not hate White people so much. But then, there's no 'Victim Points' with that, is there ?



Shaun Bailey 'Tory Mayoral Candidate' Speaking to Andrew Castle on LBC, Sunday 10th March 2019
He stated:
"Knife Crime Debate Changed When White People Started Being Stabbed"

This is pure 'Victimhood Parasitism'
Just another bleeding heart ethnic minority looking for preferential favour. (Yet again!)

All sorts of people have been making a lot of noise about knife crime for years and years.

Even Tony Blair was making a noise about it when he was PM. JUST ANOTHER VICTIMHOOD PARASITE !!!



William Wilberforce
On Friday July 26th 1833 as he lay on his deathbed Wilberforce exclaimed: "Thank God that I have lived to witness the day in which England is willing to give £20 million for the abolishment of slavery." (What would that be worth today ?)
He died three days later.

The Slavery Abolition Bill 1833 passed through the House of Lords, it received the Royal Assent (which means it became law) on 29 August 1833 and came into force on 1 August 1834. On that date slavery was abolished throughout the vast British Empire. The Act automatically applied as new possessions (principally in Africa) subsequently became part of the British Empire.

To know who rules over you. Simply find out who it is that you are not allowed to criticise.Voltaire

We, as White people, have been GAGGED!! Then bullied, insulted, demonised, and provoked, until we object and complain. We then get called *dirty names* like Nazi, Racist, White Extremist, etc, etc.

Our weak & corrupt Lib/Lab/Con Politicians are the problem. As of Jan 2021, the UK elections are years away. Check out Populism, and Nationalism ASAP. Become "WHITE WOKE" & Push Back.

Do it today, NOW!

Blair blames spate of murders on black culture

- Political correctness not helping, says PM
- Community leaders react angrily to comments

Comment: Claudia Webbe

Tony Blair yesterday claimed the spate of knife and gun murders in London was not being caused by poverty, but a distinctive black culture. His remarks angered community leaders, who accused him of ignorance and failing to provide support for black-led efforts to tackle the problem.

One accused him of misunderstanding the advice he had been given on the issue at a Downing Street summit.

Black community leaders reacted after Mr Blair said the recent violence should not be treated as part of a general crime wave, but as specific to black youth. He said people had to drop their political correctness and recognise that the violence would not be stopped "by pretending it is not young black kids doing it".

Patrick Wintour and Vikram Dodd

Thu 12 Apr 2007 18.21 BST



33

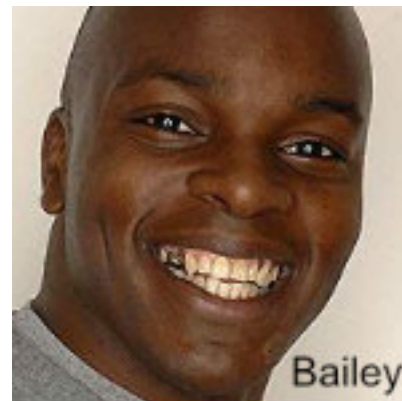

Before Mr Blair made this statement the whole topic was off limits and 'Taboo' It had been going on for years getting worse and worse but any mention of it was met with howells of Racism, Bigotry, Racial Stereotyping etc. The usual stuff that the Left and Minorities throw at us White people. I don't doubt that a man in Mr Baileys position would be very aware of this input from a previous Prime Minister.

It made a great deal of noise at the time.

Mr Bailey would have been about 36 years old then. He had to be aware, had to be. Which makes his comment on the LBC Andrew Castle show (See above right) even more 'Parasitic' than usual. The 'Screenshot' above is from the Guardian.

Bailey knows what he is appealing to, and the mind set that he is cultivating.

Terrible times ahead if this well presented 'Leech' gets into power in London.

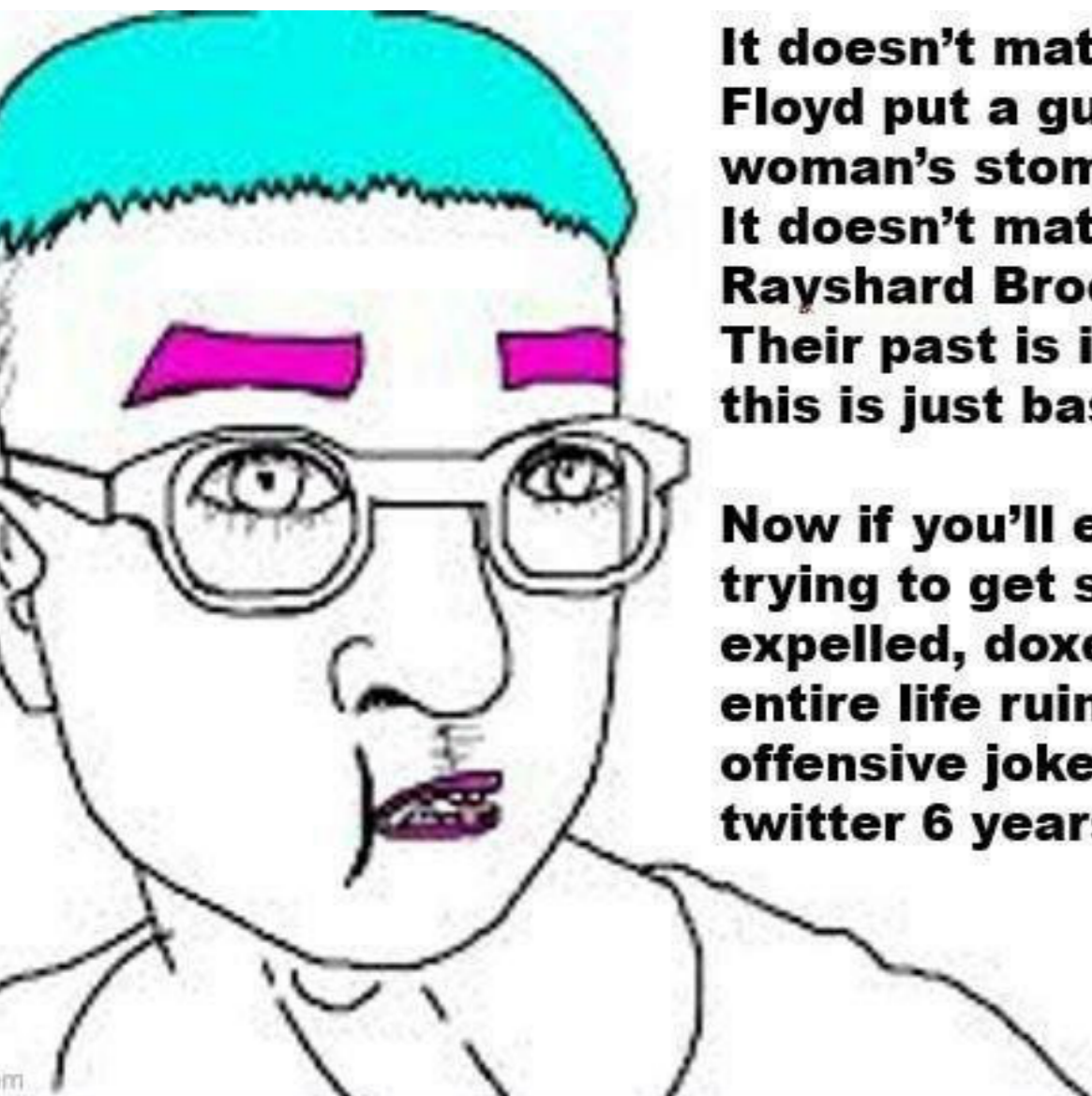

It doesn't matter that George Floyd put a gun to a pregnant woman's stomach in the past. It doesn't matter that Rayshard Brooks was abusive. Their past is irrelevant and this is just baseless shaming.

Now if you'll excuse me, I'm trying to get someone fired, expelled, doxed, and their entire life ruined for an offensive joke they made on twitter 6 years ago.

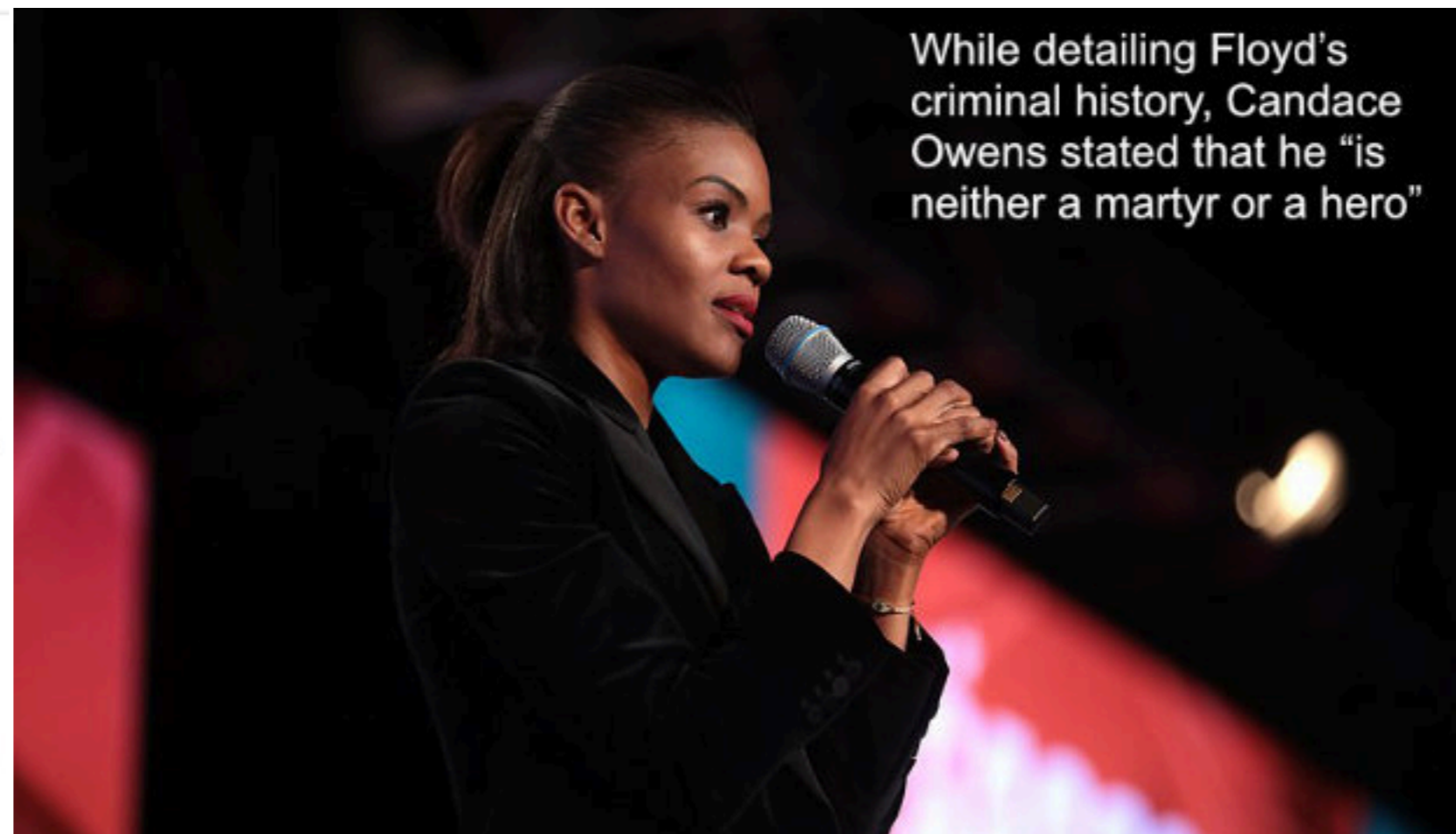

Paul Sperry @paulsperry_ · May 29

BREAKING: In 2007, **George Floyd** was charged w **armed robbery** in a Houston home invasion, according to court records. Floyd, who stands 6-6, "forced his way inside the residence, placed a pistol against the woman's abdomen & forced her into the living room."



DJ Freedom Rockets 🚀

@DJ_TPGReport

George Floyd was a felon. He held a gun to the belly of a pregnant woman and stole from her.

Demanding justice for murderous cops is one thing. Romanticizing his life when he was a convicted felon is no different than romanticizing the life of other felons - like Whitey Bulger.

8:20 AM · 09 Jun 20 · Twitter for Android



William Wilberforce

On Friday July 26th 1833 as he lay on his deathbed Wilberforce exclaimed: "Thank God that I have lived to witness the day in which England is willing to give £20 million for the abolishment of slavery." (What would that be worth today ?) He died three days later.

The Slavery Abolition Bill 1833 passed through the House of Lords, it received the Royal Assent (which means it became law) on 29 August 1833 and came into force on 1 August 1834. On that date slavery was abolished throughout the vast British Empire. The Act automatically applied as new possessions (principally in Africa) subsequently became part of the British Empire.

To know who rules over you. Simply find out who it is that you are not allowed to criticise.Voltaire

We, as White people, have been GAGGED!! Then bullied, insulted, demonised, and provoked, until we object and complain. We then get called *dirty names* like Nazi, Racist, White Extremist, etc, etc.

Our weak & corrupt Lib/Lab/Con Politicians are the problem. As of Jan 2021, the UK elections are years away. Check out Populism, and Nationalism ASAP. Become "WHITE WOKE" & Push Back.

Do it today, NOW!

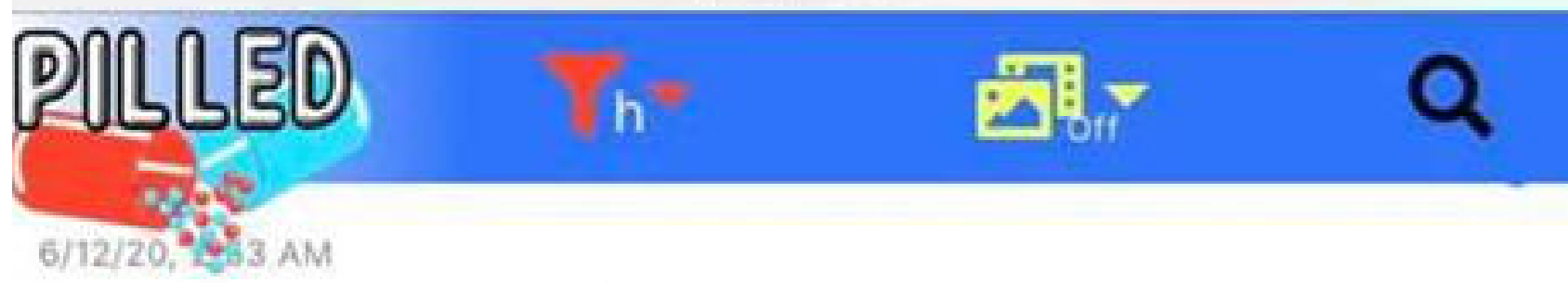

Who is George Floyd?

Her name is Aracely Henriquez. She was [#GeorgeFloyd](#)'s victim. She was pregnant when he held her at gunpoint (gun to her belly). This is your martyr: Saint George Floyd, the "Gentle Giant". [#AracelyHenriquez](#) [#GeorgeFloydProtests](#)

Aracely Henriquez was the woman kidnapped and brutally beaten by George [#Floyd](#) and his five accomplices, as they searched her home for drugs and money. She was pregnant at the time, and he asked her if she wanted him to kill her baby. News media never once mentioned her!

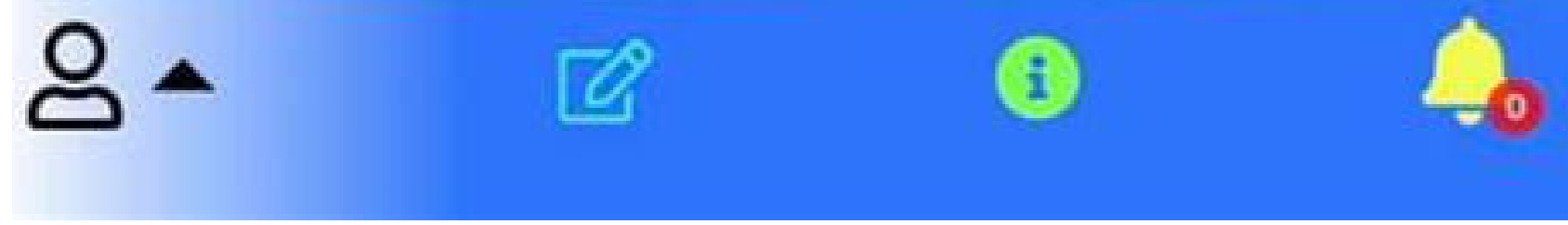

total records returned from search is 9.
Page 1 of 1

Case (Cause) Number	Style	File Date	Court	Status	Type Of Action / Offense
114323001010-3 Complete(C)	The State of Texas vs. FLOYD, GEORGE (SPN: 01610509) (DOB: 10/14/1973)	11/27/2007	337	Defendant:Disposed(D) Disposition:Disposed(DISP)	AGG ROBBERY-DEADLY WPN (F)
105047301010-3 Complete(C)	The State of Texas vs. FLOYD, GEORGE PERRY (SPN: 01610509) (DOB: 10/14/1973)	12/15/2005	179	Defendant:Disposed(D) Disposition:Disposed(DISP)	POSS W / INT DEL / MAN / DEL PG1 >=4<200G (F)
097658901010-3 Complete(C)	The State of Texas vs. FLOYD, GEORGE PERRY (SPN: 01610509) (DOB: 10/14/1973)	2/6/2004	185	Defendant:Disposed(D) Disposition:Disposed(DISP)	MAN / DEL CS PG I <1GRAM (F)
115177701010-2 Complete(C)	The State of Texas vs. FLOYD, GEORGE (SPN: 01610509) (DOB: 10/14/1973)	1/3/2003	12	Defendant:Disposed(D) Disposition:Disposed(DISP)	TRESPASS PROP / BLDG-NO FORB ENT (M)
092886901010-3 Complete(C)	The State of Texas vs. FLOYD, GEORGE LEE (SPN: 01610509) (DOB: 10/14/1973)	10/29/2002	184	Defendant:Disposed(D) Disposition:Disposed(DISP)	POSS CS PG 1 <1G (F)
107577801010-2 Complete(C)	The State of Texas vs. PERRY, FLOYD (SPN: 01610509) (DOB: 10/14/1973)	8/29/2001	5	Defendant:Disposed(D) Disposition:Disposed(DISP)	FAIL IDENT TO P-O-FUGITIVE (M)
984955901010-2 Complete(C)	The State of Texas vs. FLOYD, GEORGE (SPN: 01610509) (DOB: 10/14/1973)	12/9/1998	6	Defendant:Disposed(D) Disposition:Disposed(DISP)	THEFT - \$50-\$500 (M)
079379601010-3 Complete(C)	The State of Texas vs. FLOYD, GEORGE (SPN: 01610509) (DOB: 10/14/1973)	9/25/1998	262	Defendant:Disposed(D) Disposition:Disposed(DISP)	THEFT FROM PERSON (F)
075978001010-3 Complete(C)	The State of Texas vs. FLOYD, GEORGE (SPN: 01610509) (DOB: 10/14/1973)	8/3/1997	182	Defendant:Disposed(D) Disposition:Disposed(DISP)	MAN / DEL CS PG I <1GRAM (F)



William Wilberforce
On Friday July 26th 1833 as he lay on his deathbed Wilberforce exclaimed: "Thank God that I have lived to witness the day in which England is willing to give £20 million for the abolishment of slavery." (What would that be worth today ?) He died three days later.

The Slavery Abolition Bill 1833 passed through the House of Lords, it received the Royal Assent (which means it became law) on 29 August 1833 and came into force on 1 August 1834. On that date slavery was abolished throughout the vast British Empire. The Act automatically applied as new possessions (principally in Africa) subsequently became part of the British Empire.

To know who rules over you. Simply find out who it is that you are not allowed to criticise.Voltaire

We, as White people, have been GAGGED!! Then bullied, insulted, demonised, and provoked, until we object and complain. We then get called *dirty names* like Nazi, Racist, White Extremist, etc, etc.

Our weak & corrupt Lib/Lab/Con Politicians are the problem. As of Jan 2021, the UK elections are years away. Check out Populism, and Nationalism ASAP. Become "WHITE WOKE" & Push Back. **Do it today, NOW!**

WHAT HAPPENED TO GEORGE FLOYD?

A TIMELINE OF MAY 25, 2020

- 8.01pm Cup Foods employee calls police, alleging Floyd tried to pay with a fake \$20 note
- 8.08pm Two police officers arrive at store, where Floyd was sat in a car
- 8.14pm Struggle as officers try to put Floyd in the police car
- 8.17pm Derek Chauvin arrives on scene
- 8.19pm Chauvin pulls Floyd away from the car and onto the floor
- 8.20pm Chauvin is seen applying pressure to Floyd's neck with his knee
- 8.21pm The call from officers is upgraded to a request for emergency medical assistance
- 8.25pm Floyd appears to lose consciousness
- 8.27pm Ambulance arrives and paramedics check Floyd's pulse with Chauvin's knee still on his neck
- 8.28pm Chauvin told to take his knee off Floyd's neck and he is rolled onto a stretcher
- 9.25pm Floyd is declared dead at Hennepin County Medical Center

EXPRESS



"The goal of abolishing the white race is, on its face, so desirable that some may find it hard to believe that it could incur any opposition other than from committed white supremacists...
Make no mistake about it: we intend to keep bashing the dead white males, and the live ones, and the females too, until the social construct known as 'the white race' is destroyed."
(Professor Noel Ignatiev: *Harvard Magazine* - September-October 2002)



'I DON'T LIKE WHITE MEN, I WANT THEM TO BE A LOST SPECIES.'

Yasmin Alibhai-Brown



"You white people are on an endangered list. And unlike, say, the bald eagle or some exotic species of muskrat, you are not worth saving. In forty years or so, maybe fewer, there won't be any more white people around, and that's a good thing..."

Tim Wise - Jewish Anti-Racist Activist



Barbara Lerner Spectre

I think there is a resurgence of anti-Semitism because at this point in time Europe has not yet learned how to be multicultural. And I think we are going to be part of the throes of that transformation, which must take place. Europe is not going to be the monolithic societies they once were in the last century. Jews are going to be at the centre of that. It's a huge transformation for Europe to make. They are now going into a multicultural mode and Jews will be resented because of our leading role. But without that leading role and without that transformation, Europe will not survive.



William Wilberforce
On Friday July 26th 1833 as he lay on his deathbed Wilberforce exclaimed: "Thank God that I have lived to witness the day in which England is willing to give £20 million for the abolishment of slavery." (What would that be worth today ?)
He died three days later.

The Slavery Abolition Bill 1833 passed through the House of Lords, it received the Royal Assent (which means it became law) on 29 August 1833 and came into force on 1 August 1834. On that date slavery was abolished throughout the vast British Empire. The Act automatically applied as new possessions (principally in Africa) subsequently became part of the British Empire.

To know who rules over you. Simply find out who it is that you are not allowed to criticise.Voltaire

We, as White people, have been GAGGED!! Then bullied, insulted, demonised, and provoked, until we object and complain. We then get called *dirty names* like Nazi, Racist, White Extremist, etc, etc.

Our weak & corrupt Lib/Lab/Con Politicians are the problem. As of Jan 2021, the UK elections are years away. Check out Populism, and Nationalism ASAP. Become "WHITE WOKE" & Push Back.

Do it today, NOW!



The 'North London MUSLIM Housing Association' is building homes for, well, Muslims.

Supported by the Muslim Mayor of London, it looks like an entire little ghetto estate of brand new Muslim-only households is being created.

What is Genocide?

The word:

- Raphael Lemkin, Polish-Jewish lawyer, 1944
- Geno (race or tribe) and Cide (killing)

The United Nations Definition of Genocide

"Genocide means any of the following acts committed with intent to destroy, in whole or in part, a national, ethnical, racial or religious group, as such:

- (a) Killing members of the group;
- (b) Causing serious bodily or mental harm to members of the group;
- (c) Deliberately inflicting on the group conditions of life calculated to bring about its physical destruction in whole or in part;
- (d) Imposing measures intended to prevent births within the group;
- (e) Forcibly transferring children of the group to another group".



William Wilberforce

On Friday July 26th 1833 as he lay on his deathbed Wilberforce exclaimed: "Thank God that I have lived to witness the day in which England is willing to give £20 million for the abolishment of slavery." (What would that be worth today?)

He died three days later.

The Slavery Abolition Bill 1833 passed through the House of Lords, it received the Royal Assent (which means it became law) on 29 August 1833 and came into force on 1 August 1834. On that date slavery was abolished throughout the vast British Empire.

The Act automatically applied as new possessions (principally in Africa) subsequently became part of the British Empire.

To know who rules over you. Simply find out who it is that you are not allowed to criticise.Voltaire

We, as White people, have been GAGGED!! Then bullied, insulted, demonised, and provoked, until we object and complain. We then get called *dirty names* like Nazi, Racist, White Extremist, etc, etc.

Our weak & corrupt Lib/Lab/Con Politicians are the problem. As of Jan 2021, the UK elections are years away. Check out Populism, and Nationalism ASAP. Become "WHITE WOKE" & Push Back.

Do it today, NOW!

DIVERSITY for DUMMIES

It's just basic Arithmetic. To say you want more Ethnic Diversity, is exactly the same as saying that you want 'Less' of the ethnicity that you have already got. How RACIST is that? In 2011, native British Whites became a minority group in London. The same is true of a number of other large British cities. Am I a Racist? Absolutely not! I want more ethnic minorities every bit as much as they want more of me. How much is that?

When any minority is 'Positively' selected. It means that many White People have been 'Racially Profiled' to be sent to the back of the queue.



Diversity ?
We were NEVER asked.
From the very beginning,
it has been FORCED upon us.



**William Wilberforce**

On Friday July 26th 1833 as he lay on his deathbed Wilberforce exclaimed: "Thank God that I have lived to witness the day in which England is willing to give £20 million for the abolishment of slavery." (What would that be worth today?)

He died three days later.

The Slavery Abolition Bill 1833 passed through the House of Lords, it received the Royal Assent (which means it became law) on 29 August 1833 and came into force on 1 August 1834. On that date slavery was abolished throughout the vast British Empire.

The Act automatically applied as new possessions (principally in Africa) subsequently became part of the British Empire.

To know who rules over you. Simply find out who it is that you are not allowed to criticise.

.....Voltaire

We, as White people, have been GAGGED!! Then bullied, insulted, demonised, and provoked, until we object and complain. We then get called *dirty names* like Nazi, Racist, White Extremist, etc, etc.

Our weak & corrupt Lib/Lab/Con Politicians are the problem. As of Jan 2021, the UK elections are years away. Check out Populism, and Nationalism ASAP. Become "WHITE WOKE" & Push Back.

Do it today, NOW!

Start with a cage containing five monkeys

(Or a School Classroom)

Inside the cage, hang a banana on a string and place a set of stairs under it. Before long, a monkey will go to the stairs and start to climb towards the banana. As soon as he touches the stairs, spray all of the other monkeys with cold water. After a while, another monkey makes an attempt with the same result all the other monkeys are sprayed with cold water. Pretty soon, when another monkey tries to climb the stairs, the other monkeys will try to prevent it.

Now, put away the cold water.

Remove one monkey from the cage and replace it with a new one. The new monkey sees the banana and wants to climb the stairs. To his surprise and horror, all of the other monkeys attack him. After another attempt and attack, he knows that if he tries to climb the stairs, he will be assaulted.

Next, remove another of the original five monkeys and replace it with a new one. The newcomer goes to the stairs and is attacked.

The previous newcomer takes part in the punishment with enthusiasm !

Likewise, replace a third original monkey with a new one, then a fourth, then the fifth. Every time the newest monkey takes to the stairs, he is attacked.

Most of the monkeys that are beating him have no idea why they were not permitted to climb the stairs or why they are participating in the beating of the newest monkey. After replacing all the original monkeys, none of the remaining monkeys have ever been sprayed with cold water.

Nevertheless, no monkey ever again approaches the stairs to try for the banana.

Why not ?

Because as far as they know that's the way it's always been done around here.

And that, my friends, is how a company policy begins.

(Or "PC" Brainwashing)

I exist to brainwash and programme you.

Tune in for your daily dose of lies, propaganda and cultural marxist conditioning of you and your children.

Everything faded into mist, the past erased, the erasure forgotten, the lie became truth.

You will come to view what I portray as reality, you will see the world and its history how I want you to see it.

You will not question, or turn me off, I am your children's educator.

I will distract you from the real world and what is happening around you, and you will see me as your comforting all knowledgeable, honest, impartial companion. In truth, I will send out contradictory signals of what is left or right, good or bad, male or female. I will also misinform and under inform you, to fry and scramble your brain, so that you become incapable of independent thought.

My partners in 'Thought Control' The printed media, will do the same. Together, we will bounce you up and down, until your brain turns **OFF!**

Alternatively, tune in to SeanBryson.com

Idiotbox Ltd - Downing St - London SW1

COLOR TINT BLACK LEVEL PICTURE



Aldous Huxley
(1894-1963)

"There will be in the next generation or so a pharmacological method of making people love their servitude and producing dictatorship without tears so to speak. Producing a kind of painless concentration camp for entire societies so that people will in fact have their liberties taken away from them, but will rather enjoy it, because they will be distracted from any desire to rebel by propaganda, or brainwashing, or brainwashing enhanced by pharmacological methods. And this seems to be the final revolution."

The Coudenhove-Kalergi Plan For The Genocide Of The White People Of Europe

Richard Coudenhove-Kalergi was a Jewish writer financed by Jewish bankers. In 1922 he founded the Pan-European Movement whose goal was to create a federation of European Nations to be led by the United States of America. Among his first supporters was the Jewish banker Max Warburg who donated 60,000 marks to this evil, racist cause. In 1925 he wrote the book Practical Idealism which has become the bible for multiculturalists and supporters of the European Union. He didn't appear in public much, but moved behind the scenes with his project for European integration, and the creation of a new mixed-race slave race to serve a Jewish master-race. This is the basis for the New World Order.



Richard Coudenhove-Kalergi

In Practical Idealism Coudenhove-Kalergi states:

The man of the future will be of mixed race. The races and classes of today will gradually disappear due to the elimination of space, time and prejudice. The Eurasian-negroid race of the future, similar in appearance to the Ancient Egyptians, will replace the diversity of peoples and the diversity of individuals. Instead of destroying European Judaism, Europe, against her will, refined and educated this people, driving them to their future status as a leading Nation through this artificial evolutionary process. It's not surprising that the People that escaped from the Ghetto-prison, became the spiritual nobility of Europe. Thus, the compassionate care given by Europe created a new breed of aristocrats. This happened when the European feudal aristocracy crashed because of the emancipation of the Jews [due to the French Revolution].



The Coudenhove-Kalergi Prize is given every two years to the European Politician who has done most to hasten this genocide and destruction of European Nations. Winners of the Coudenhove-Kalergi Prize have included Angela Merkel (2010) and Herman Van Rompuy (2012).

G. Brock Chisholm, former director of the World Health Organisation, has stated "What people in all places have to do is to limit birth-rates and promote mixed marriages, this aims to create a single race in the World which will be directed by a central authority." The main purpose of this is to create a group of People without ethnic or National identity, and therefore any cohesion.

Harvard University Jewish Professor teaches freely

"Abolish the White race by any means necessary"

Imagine a Christian Professor teaching "Abolish the Jewish race", he would be fired, maybe jailed, and all the mainstream media will talk about him for six months

"Whiteness is a form of racial oppression. Treason to whiteness is loyalty to humanity. The goal of abolishing the White race is on its face so desirable that some may find it hard to believe that it could incur any opposition other than from committed White supremacists. The task is to bring this minority together in such a way that it makes it impossible for the legacy of whiteness to continue to reproduce itself." ~ PROF. NOEL IGNATIEV



Jewish activists promote hatred against whites, indoctrinate non whites to blame whites instead of Jews for all miseries, incite for crimes, violence and discrimination against whites, indoctrinate whites that they are guilty, racist, supremacists, oppressors, evil, and therefore should welcome all the poor people of the world in their white-majority countries and become a minority

Racist test

Do you like him any better white?



No?

Me neither.

See, you're not a racist.

Home



Index



William Wilberforce

On Friday July 26th 1833 as he lay on his deathbed Wilberforce exclaimed: "Thank God that I have lived to witness the day in which England is willing to give £20 million for the abolishment of slavery." (What would that be worth today?)

He died three days later.

The Slavery Abolition Bill 1833 passed through the House of Lords, it received the Royal Assent (which means it became law) on 29 August 1833 and came into force on 1 August 1834. On that date slavery was abolished throughout the vast British Empire.

The Act automatically applied as new possessions (principally in Africa) subsequently became part of the British Empire.

To know who rules over you. Simply find out who it is that you are not allowed to criticise.Voltaire

We, as White people, have been GAGGED!! Then bullied, insulted, demonised, and provoked, until we object and complain. We then get called *dirty names* like Nazi, Racist, White Extremist, etc, etc.

Our weak & corrupt Lib/Lab/Con Politicians are the problem. As of Jan 2021, the UK elections are years away. Check out Populism, and Nationalism ASAP. Become "WHITE WOKE" & Push Back.

Do it today, NOW!

BLACK LIBERAL DEMOCRATS AT AMERICAN UNIVERSITY DEMAND THAT WHITES NOT BE ALLOWED TO ENTER CERTAIN FACILITIES AND BE SEGREGATED ONLY TO PLACES WHERE THE BLACK STUDENTS ALLOW THEM TO GO...

NO WHITES ALLOWED



BECAUSE ALL WHITES ARE RACIST BIGOTS

Politifake.org

FED UP WHITE PERSON

I'M TIRED OF BEING LABELED A "RACIST" BECAUSE OF THE COLOR OF MY SKIN

White Privilege?
Is a myth perpetuated by those who hate White people

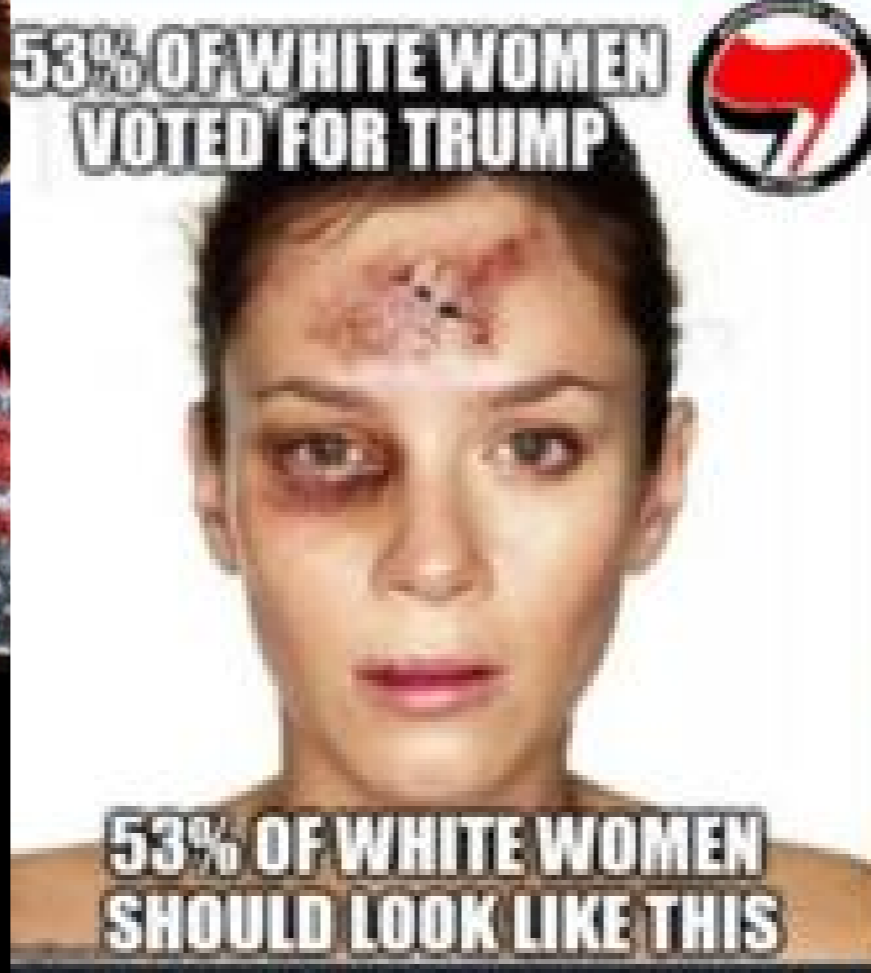

"The white race is the cancer of human history."

- Jewish activist Susan Sontag



William Wilberforce

On Friday July 26th 1833 as he lay on his deathbed Wilberforce exclaimed: "Thank God that I have lived to witness the day in which England is willing to give £20 million for the abolishment of slavery." (What would that be worth today ?) He died three days later.

The Slavery Abolition Bill 1833 passed through the House of Lords, it received the Royal Assent (which means it became law) on 29 August 1833 and came into force on 1 August 1834. On that date slavery was abolished throughout the vast British Empire. The Act automatically applied as new possessions (principally in Africa) subsequently became part of the British Empire.

To know who rules over you. Simply find out who it is that you are not allowed to criticise.Voltaire

We, as White people, have been GAGGED!! Then bullied, insulted, demonised, and provoked, until we object and complain. We then get called *dirty names* like Nazi, Racist, White Extremist, etc, etc.

Our weak & corrupt Lib/Lab/Con Politicians are the problem. As of Jan 2021, the UK elections are years away. Check out Populism, and Nationalism ASAP. Become "WHITE WOKE" & Push Back.

Do it today, NOW!

Jussie Smollett indicted on 16 counts over fake hate crime

MILNE NEWS
www.milne.news.com



In African countries run by Black people, Blacks are much poorer and more oppressed than Black Americans.

So overall, White people make Black lives better.

Dixon Diaz 2017



STOP THE ANTI-WHITE HATE

Apology: Jarel Robinson-Brown appeared to dismiss the work of the Covid fund-raiser, whose efforts were praised by all political leaders and the Archbishop of Canterbury



Jarel Robinson-Brown || Black Pro...
@JarelRB

The cult of Captain Tom is a cult of White British Nationalism.

I will offer prayers for the repose of his kind and generous soul, but I will not be joining the "National Clap".

12:18 · 03/02/2021 · Twitter Web App



© EPA
Captain Tom became a national treasure during the first coronavirus lockdown after he raised £33 million for the NHS by doing laps of his garden. His death was met with an out-pouring of grief with the Queen leading tributes

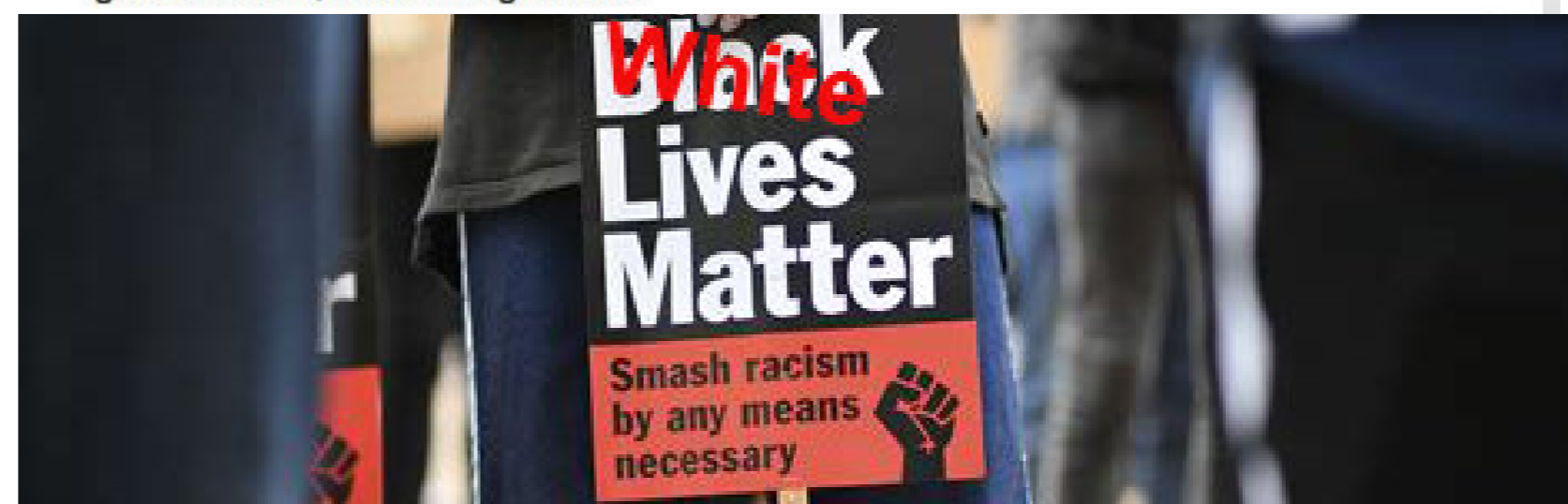

William Wilberforce

On Friday July 26th 1833 as he lay on his deathbed Wilberforce exclaimed: "Thank God that I have lived to witness the day in which England is willing to give £20 million for the abolishment of slavery." (What would that be worth today?)

He died three days later.

The Slavery Abolition Bill 1833 passed through the House of Lords, it received the Royal Assent (which means it became law) on 29 August 1833 and came into force on 1 August 1834. On that date slavery was abolished throughout the vast British Empire.

The Act automatically applied as new possessions (principally in Africa) subsequently became part of the British Empire.

To know who rules over you. Simply find out who it is that you are not allowed to criticise.Voltaire

We, as White people, have been GAGGED!! Then bullied, insulted, demonised, and provoked, until we object and complain. We then get called *dirty names* like Nazi, Racist, White Extremist, etc, etc.

Our weak & corrupt Lib/Lab/Con Politicians are the problem. As of Jan 2021, the UK elections are years away. Check out Populism, and Nationalism ASAP. Become "WHITE WOKE" & Push Back.

Do it today, NOW!

Videos About Slavery



William Wilberforce

- English member of parliament and a social reformer
- first elected in 1780
- played a huge role in ending slavery as well as an advocate for social reform
- Slavery was a universal, worldwide evil
- every culture and civilization practiced it
- Eric Metaxas - "Amazing Grace"
- Slavery was as accepted as birth and marriage and death, was so woven into the tapestry of human history that you could barely see its threads, much less pull them out. Everywhere on the globe, for 5,000 years, the idea of human civilization without slavery was unimaginable ...

William Wilberforce - A Great Man Forgotten. A man who you have probably never heard of but is one of the greatest men in the history of Western Civilization. He is William Wilberforce. He was an English member of parliament, and a social reformer. Elected in 1780.

[Open](#)

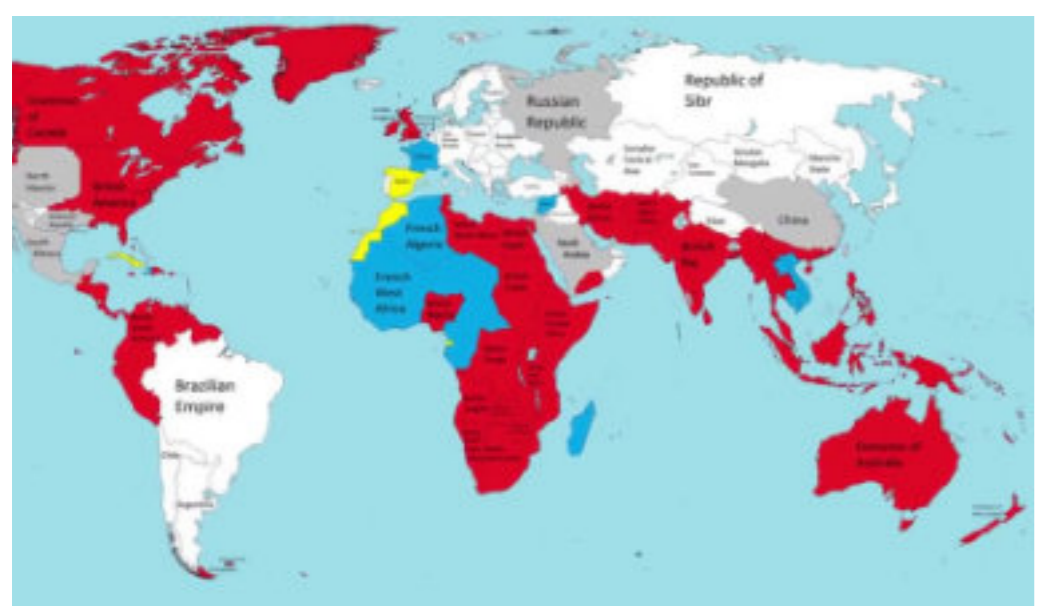

How the British and their Empire, abolished slavery WORLDWIDE. The British Empire is long dead, but it's effects are still brought up in political discussions today.

[Open](#)



The British Crusade Against Slavery. "Britain's criminally stupid attitudes to race and Immigration are beyond parody. By Frankie Boyle. Frankie Boyle is a famous Scottish comedian, who is most renowned for being pretty damn offensive.

[Open](#)



Abraham Lincoln and the Abolition of Slavery in the United States
Charles Godfrey Leland (1824 - 1903)

The Best Audio Book Classic

Audio Books Classic

This an Audio Book of just under 6 hours duration. Well worth listening to. Lots of stuff not taught to children in our schools. Why not? Download and listen later.

[Open](#)



Remember how you were told your Grandfather was out walking with his girlfriend one day and some White guy jumped out of the bushes with a net and took him away to be a slave ? That's not what happened.

[Open](#)

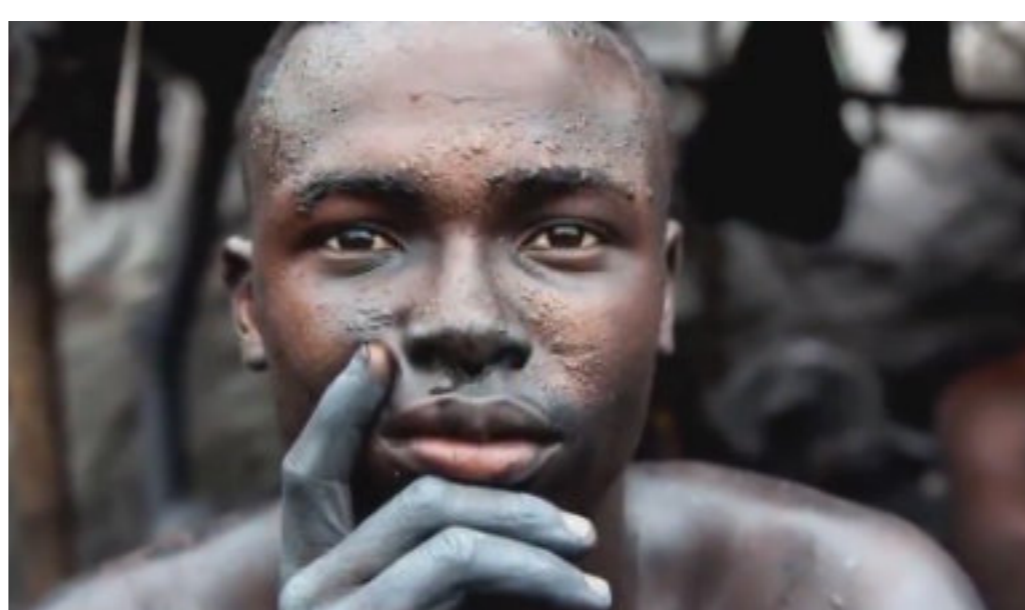

SLAVERY: PAST, PRESENT AND FUTURE (Banned on YouTube) First of all we have to understand what it is, and where it came from. Slavery is an ancient institution common to all cultures in history.

[Open](#)



The truth about the Arab Slave Trade in Sudan. Slavery ! It used to be legal everywhere and it was practised everywhere. In the 21st century it's illegal, but guess what, it's still practised everywhere.

[Open](#)



At last we find what we have been searching for 6 months along the Persian Gulf. An open market in Human Beings.

[Open](#)



William Wilberforce
On Friday July 26th 1833 as he lay on his deathbed Wilberforce exclaimed: "Thank God that I have lived to witness the day in which England is willing to give £20 million for the abolishment of slavery." (What would that be worth today ?) He died three days later.

The Slavery Abolition Bill 1833 passed through the House of Lords, it received the Royal Assent (which means it became law) on 29 August 1833 and came into force on 1 August 1834. On that date slavery was abolished throughout the vast British Empire. The Act automatically applied as new possessions (principally in Africa) subsequently became part of the British Empire.

To know who rules over you. Simply find out who it is that you are not allowed to criticise.Voltaire

We, as White people, have been GAGGED!! Then bullied, insulted, demonised, and provoked, until we object and complain. We then get called *dirty names* like Nazi, Racist, White Extremist, etc, etc.

Our weak & corrupt Lib/Lab/Con Politicians are the problem. As of Jan 2021, the UK elections are years away. Check out Populism, and Nationalism ASAP. Become "WHITE WOKE" & Push Back. **Do it today, NOW!**

[More Educational Videos](#)

'RACE' THE FINAL FRONTIER & Kristen Clarke



Kristen Clarke - President Joe Biden's choice to head the Civil Rights Division of the Justice Department.

RACE & INTELLIGENCE

Well, this 'Great Debate' is now well and truly on the agenda.

Who would ever have imagined that this debate would be blown wide open to the public, by a Black woman working in a high position of the American Government ?

On this and the following page, you will find eight screen shots taken from a Tucker Carlson video highlighting some of the main points of Ms Kristen Clarke's position on race and intelligence etc.

On the following pages I am going to openly champion the White Man. In the same way that Ms Clarke openly champions the Black Man. Sounds pretty equal to me.

One of the greatest Abortions of the mind in recent years is the way that Dr James Watson was stripped of the honours that he and Dr Francis Crick received for discovering 'DNA' Do the words 'Crick & Watson' ring a bell ?

Dr Watson fell foul of the Marxist 'PC' Brigade for stating that there were genetic differences between Blacks and Whites, and part of that difference was a genetic difference in intelligence. For this 'Thought Crime' Dr Watson was stripped of his honours for his work on 'DNA' Why ?

This sort of vicious vindictiveness is designed to send a clear message to anyone else thinking of rocking the Marxist boat.

And the message is this:-

Shut your mouth and agree with us, or we will come for you.

Follow the link below to American Renaissance for lots of additional interesting info !! Highly Recommended !!



William Wilberforce

On Friday July 26th 1833 as he lay on his deathbed Wilberforce exclaimed: "Thank God that I have lived to witness the day in which England is willing to give £20 million for the abolishment of slavery." (What would that be worth today ?) He died three days later.

The Slavery Abolition Bill 1833 passed through the House of Lords, it received the Royal Assent (which means it became law) on 29 August 1833 and came into force on 1 August 1834. On that date slavery was abolished throughout the vast British Empire. The Act automatically applied as new possessions (principally in Africa) subsequently became part of the British Empire.

To know who rules over you. Simply find out who it is that you are not allowed to criticise.Voltaire

We, as White people, have been GAGGED!! Then bullied, insulted, demonised, and provoked, until we object and complain. We then get called *dirty names* like Nazi, Racist, White Extremist, etc, etc.

Our weak & corrupt Lib/Lab/Con Politicians are the problem. As of Jan 2021, the UK elections are years away. Check out Populism, and Nationalism ASAP. Become "WHITE WOKE" & Push Back.

Do it today, NOW!

Francis Crick Was a Race Realist, Too

Gregory Hood, American Renaissance, January 16, 2019

From <https://www.amren.com/commentary/2019/01/francis-crick-was-a-race-realist-too>

The world's greatest living scientist, [Dr. James Watson](#), was recently stripped of his honors for speaking the heretical truth about race differences in intelligence. Yet purging Dr. Watson will not be enough for egalitarian fanatics — his partner in the discovery of DNA, Dr. Francis Crick, was also a race realist. Presumably, his memory will also be attacked.

The [Francis Crick Papers](#) are online. Steve Sailer [has shown](#) that several contain sensible perspectives on race. The papers also show that Crick defended the right of scientists such as [Dr. William Shockley](#) not just to promote scientific truths but to suggest policies based on those truths. If Dr. James Watson's contributions must be purged, so too must Crick's.

In 1970, in response to a research proposal by Dr. William Shockley, seven members of the National Academy of Sciences sent a letter to the president of the NAS arguing that it should not investigate the genetic basis for racial differences in intelligence. "It is basically vicious to evaluate individuals on the basis of the group to which they belong," argued the letter-writers. In response, in 1971, [Crick wrote to one of Dr. Shockley's critics](#), Dr. John Edsall, and expressed the view that racial differences are real.

In brief I think it likely that more than half the difference between the average I.Q. of American whites and Negroes is due to genetic reasons, and will not be eliminated by any foreseeable change in environment. Moreover I think the social consequences of this are likely to be rather serious unless steps are taken to recognize the situation.

Crick expressed his support for the arguments of [Dr. Arthur Jensen](#) regarding human differences. He challenged Shockley's critics to explain what mistakes Jensen had made and to describe the research they think should be done to determine "to what extent 'intelligence' is inherited." Crick criticized Jensen's opponents for having made "unsupported statements of opinion" rather than referring to scientific arguments. Crick even threatened to resign as a Foreign Associate from the NAS if "the Academy were to take active steps to suppress reputable scientific research for political reasons."

Edsall's [response](#) was gracious. He wrote that he regards "inquiry into the role of genetic and environmental factors in the development of intelligence as a valid and important field of research," albeit one "difficult and complex." He criticized Shockley for demanding a "crash program" rather than a serious inquiry, and suggested Shockley was making himself into a nuisance, "pushing his demands again and again at Academy business meetings, when there was other urgent business to be done." Edsall also said that the statement against Shockley did not

BIDEN PICK ON BLACK & WHITE GENETICS

"Three: Carol Barnes notes that human mental processes are controlled by melanin--that same chemical which gives Blacks their superior physical & mental abilities."

FOX NEWS LIVE TUCKER INVESTIGATES EXCLUSIVE: SHOCKING STATEMENTS BY KRISTEN CLARKE
Standing Up For What's Right.

BIDEN PICK ON BLACK & WHITE GENETICS

"Four: Some scientists have revealed that most whites are unable to produce melanin because their pineal glands are often calcified or non-functioning."

FOX NEWS channel TUCKER INVESTIGATES EXCLUSIVE: SHOCKING STATEMENTS BY KRISTEN CLARKE
TUCKER CARLSON tonight #Tucker

BIDEN PICK ON BLACK & WHITE GENETICS

"Pineal calcification rates with Africans are five to 15 percent, Asians 15 to 25 percent and Europeans 60 to 80 percent. This is the chemical basis for the cultural differences between Blacks and whites."

FOX NEWS LIVE TUCKER INVESTIGATES EXCLUSIVE: SHOCKING STATEMENTS BY KRISTEN CLARKE
HEAD OF LONDON-BASED GLOBAL TRAVEL ORG ON MON SAID SHE'S OPPOSED

BIDEN PICK ON BLACK & WHITE GENETICS

"Five: Melanin endows Blacks with greater mental, physical and spiritual abilities — something which cannot be measured based on Eurocentric standards."

FOX NEWS LIVE TUCKER INVESTIGATES EXCLUSIVE: SHOCKING STATEMENTS BY KRISTEN CLARKE
Standing Up For What's Right.



William Wilberforce
On Friday July 26th 1833 as he lay on his deathbed Wilberforce exclaimed: "Thank God that I have lived to witness the day in which England is willing to give £20 million for the abolishment of slavery." (What would that be worth today ?)
He died three days later.

The Slavery Abolition Bill 1833 passed through the House of Lords, it received the Royal Assent (which means it became law) on 29 August 1833 and came into force on 1 August 1834. On that date slavery was abolished throughout the vast British Empire. The Act automatically applied as new possessions (principally in Africa) subsequently became part of the British Empire.

To know who rules over you. Simply find out who it is that you are not allowed to criticise.Voltaire

We, as White people, have been GAGGED!! Then bullied, insulted, demonised, and provoked, until we object and complain. We then get called *dirty names* like Nazi, Racist, White Extremist, etc, etc.

Our weak & corrupt Lib/Lab/Con Politicians are the problem. As of Jan 2021, the UK elections are years away. Check out Populism, and Nationalism ASAP. Become "WHITE WOKE" & Push Back. **Do it today, NOW!**



William Wilberforce
 On Friday July 26th 1833 as he lay on his deathbed Wilberforce exclaimed: "Thank God that I have lived to witness the day in which England is willing to give £20 million for the abolishment of slavery." (What would that be worth today ?)
 He died three days later.

The Slavery Abolition Bill 1833 passed through the House of Lords, it received the Royal Assent (which means it became law) on 29 August 1833 and came into force on 1 August 1834. On that date slavery was abolished throughout the vast British Empire. The Act automatically applied as new possessions (principally in Africa) subsequently became part of the British Empire.

To know who rules over you. Simply find out who it is that you are not allowed to criticise.Voltaire

We, as White people, have been GAGGED!! Then bullied, insulted, demonised, and provoked, until we object and complain. We then get called *dirty names* like Nazi, Racist, White Extremist, etc, etc.

Our weak & corrupt Lib/Lab/Con Politicians are the problem. As of Jan 2021, the UK elections are years away. Check out Populism, and Nationalism ASAP. Become "WHITE WOKE" & Push Back.

Do it today, NOW!

percent wanted to encourage "policies based on science." That would require a willingness to acknowledge scientific realities such as racial differences. If marchers are sincere, they have a great opportunity to stand for truth at the next event.

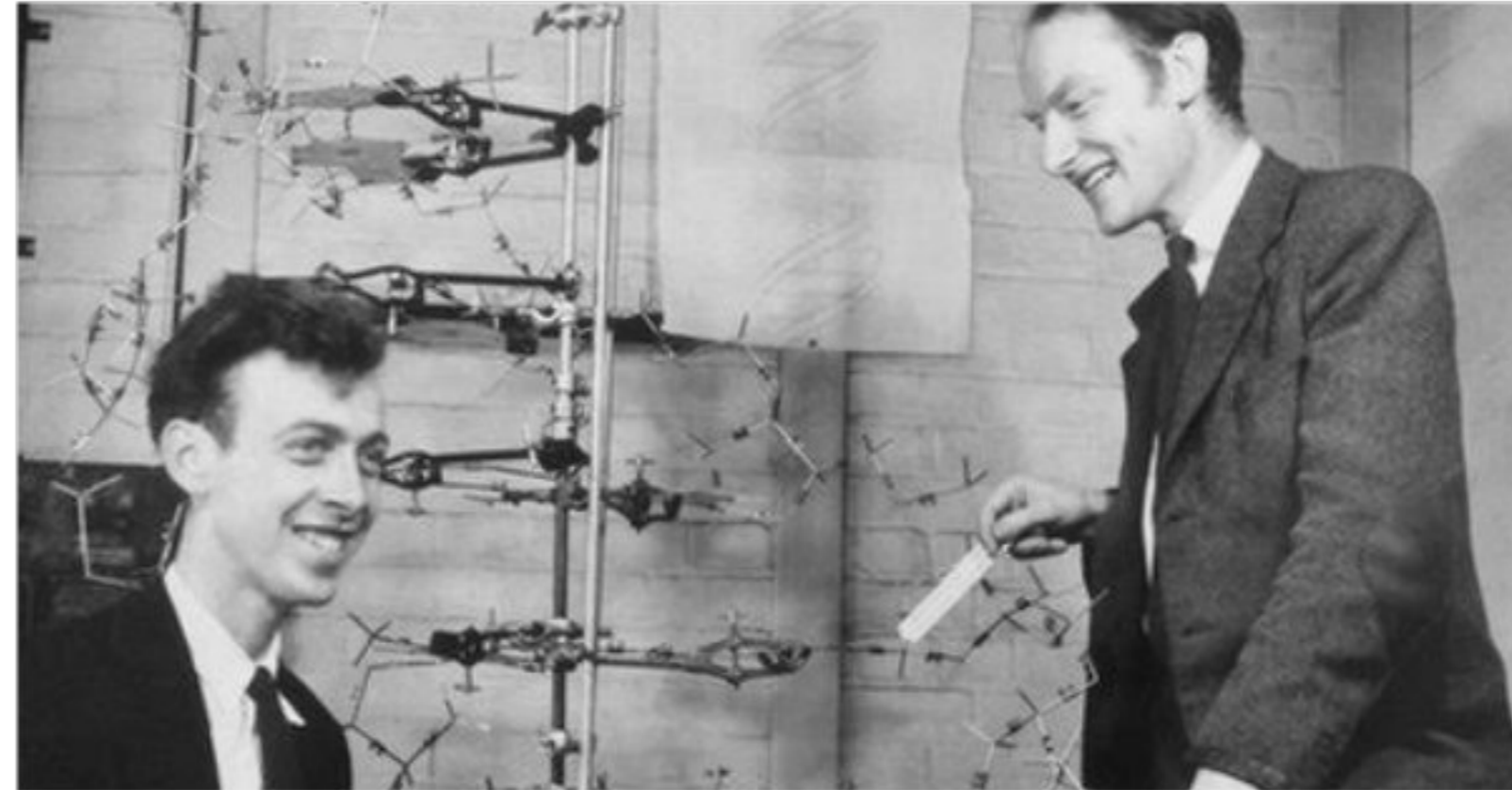

Watson & Crick. The early years.

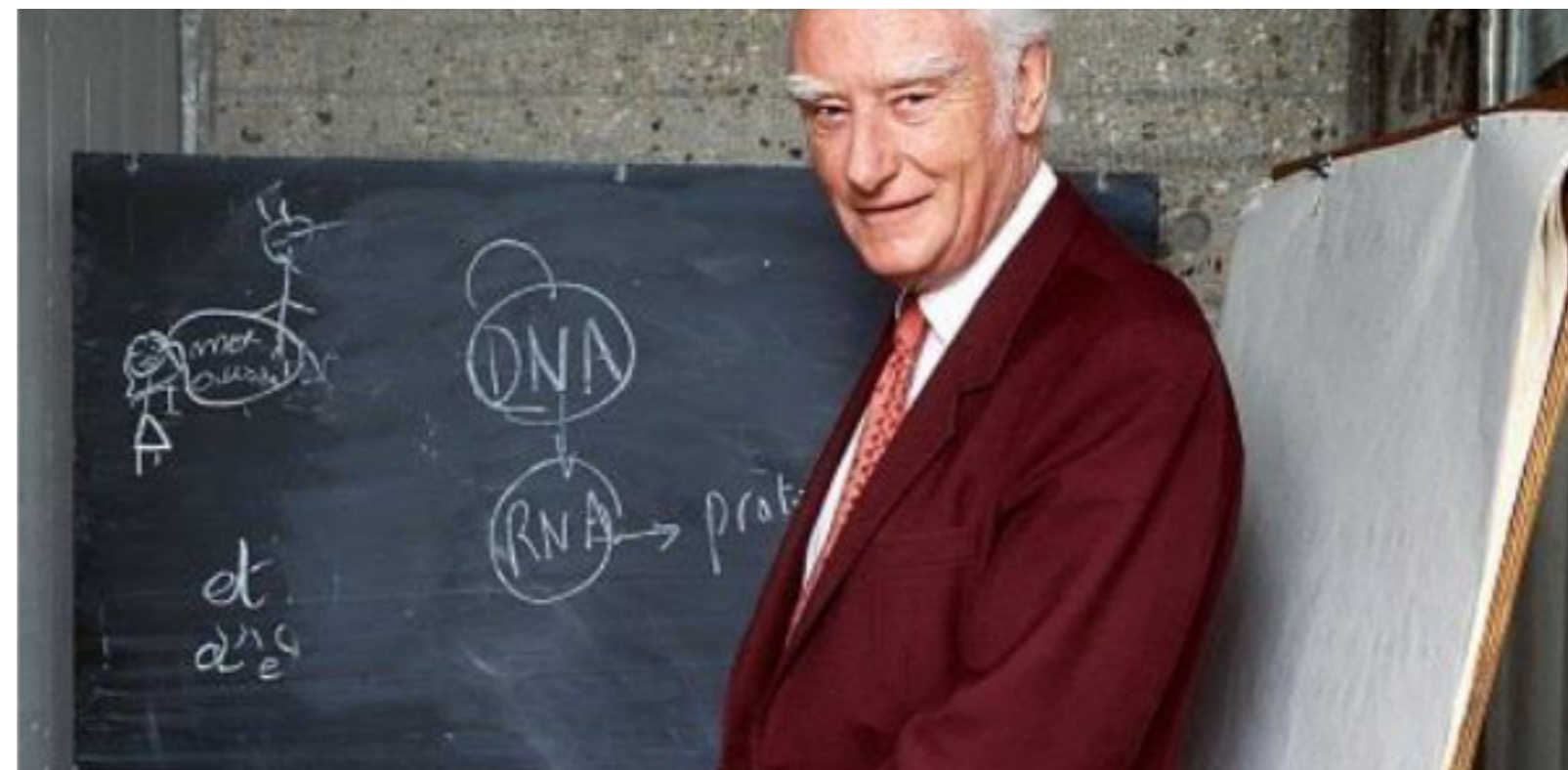

Francis Crick

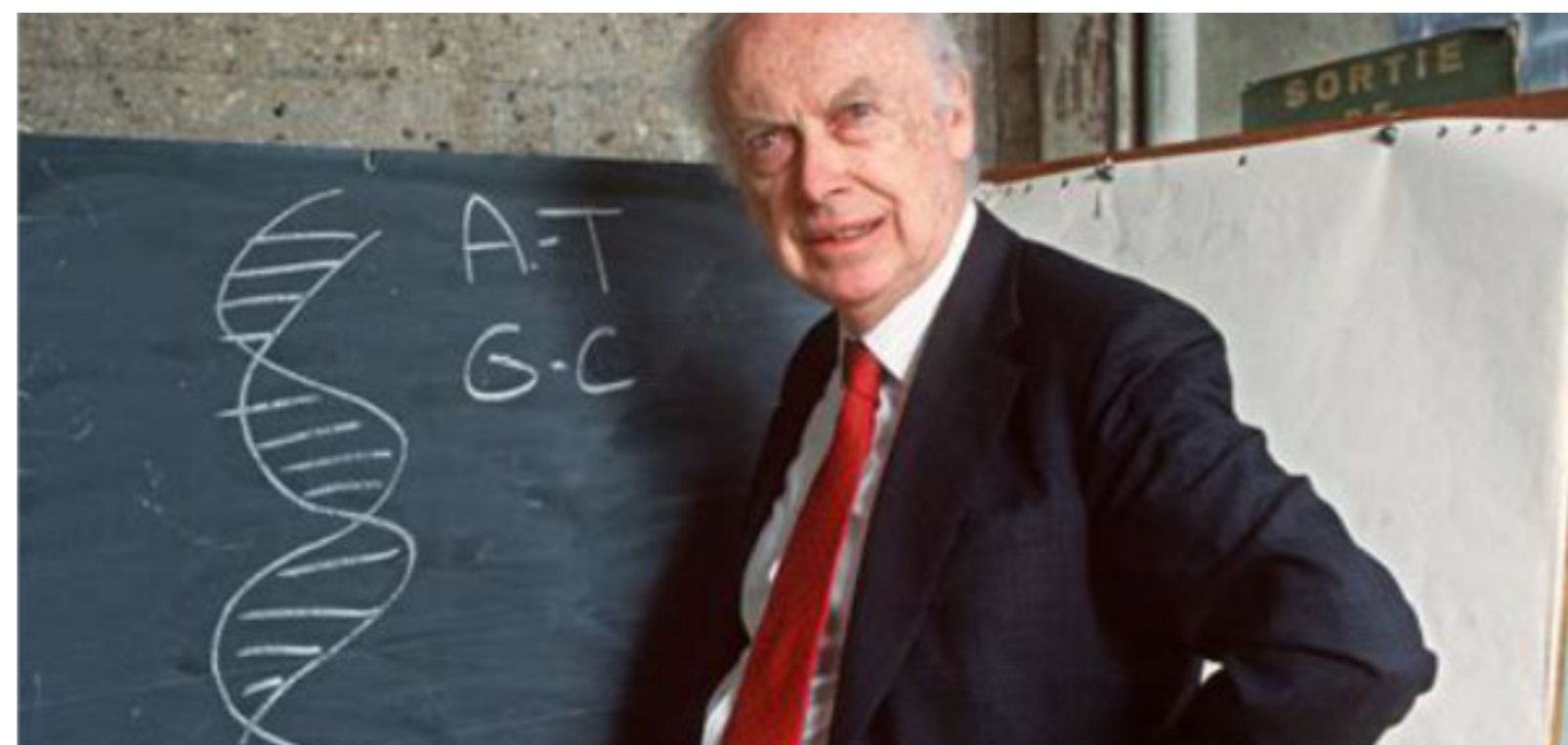

James Watson

mention Jensen, and that he draws a distinction between the two. Edsall even noted that he was called a "racist" by colleagues when he described an article by Jensen as a "thoughtful, careful, and scholarly piece of work," though he did not necessarily agree with all of Jensen's conclusions.

Crick [responded](#) again to Edsall, going even further in defense of race realism. In response to Edsall's hypothesis that cultural factors could explain race differences in IQ tests, Crick asked, "How do you explain the relatively poor I.Q. performance of the children of middle-class American negroes?" He defended the usefulness of I.Q. tests while acknowledging "their obvious limitations." He bemoaned the lack of "constructive approaches" to examining the genetic basis of intelligence, an suggested funding for experiments, but realized they would not be forthcoming because of political pressure.

In [response](#), Edsall again restated the complexity of the intelligence question and suggested "stopping human population in growth is a matter of the highest priority" and "deserves a far higher priority, to my mind, than the issues raised by Jensen and Shockley." "I am not against eugenics in principle," Edsall also wrote, joining Crick in hoping it could be rehabilitated. (Crick [noted](#) that "the Nazis gave it a bad name and I think it is time something was done to make it respectable again.")

Edsall's suggestion of a future "positive eugenics" program and restriction on world population growth (in practice, [limiting African growth](#)) would both undoubtedly be called racist today. Luckily for his reputation, Edsall died in 2002.

Crick also [criticized](#) affirmative action (which he called "negative racism") in correspondence with another one of Dr. Shockley's opponents, Dr. Ernst Mayr.

That is, the acceptance by Universities (like Harvard) of students with considerably lower standards merely because they are black. This policy is certainly going to lead to trouble. Either many of them will drop out, or they will have to be given degrees where white people would be failed.

It certainly has led to a great deal of "trouble."

Mr. Sailer identifies other letters in which Crick explicitly endorsed racial differences in intelligence. [In a letter to Lord C.P. Snow in 1969, Crick wrote:](#)

I said that the biological evidence was that all men were not created equal, and it would not only be difficult to try to do this, but biologically undesirable. As an a[s]ide I said that the evidence for the equality of different races did not really exist. In fact, what little evidence there was suggested racial differences.

Crick's dedication to the pursuit of truth comes through in every one of these letters. He urges his correspondents to show courage in the face of criticism, examine ideas fearlessly, and pursue evidence wherever it leads. His belief in race realism was not a moral conviction nor an expression of racial pride. Race realism simply is; racial differences are a biological reality and exist no matter who suppresses, ignores, or complains about them. That is the scientific view, but it is not what science is today.

On April 22, 2017, an estimated 100,000 people participated in the first annual March for Science in Washington, D.C. Tens of thousands participated in other cities, with more than a million around the world. A study of supporters found 97

By Aryan Species

From <http://www.vanguardnewsnetwork.com/index327.htm>

At this moment in history the white race/species is on the verge of complete genetic annihilation. How can this be possible? Only 100 years ago our species ruled the world. Our people made up 1/3 of the total population of the planet. We had expanded from our ancient homelands of Europe to new lands in North America, South America, Australia, and New Zealand. Yet, today we only make up 7% of the total population of the world, all white countries have birth rates below replacement. Why?

Personally I reject the idea of a single human species; there is ample scientific evidence to suggest that the standard definition which states that "any two life forms that can breed and produce fertile offspring are of the same species" is misguided at best. Many life forms that are clearly from different species are capable of producing fertile offspring. For example, buffalo and cattle are considered different species but are capable of producing fertile offspring; wolves and coyotes are also considered different species but are capable of producing fertile offspring. Other examples include: lions/tigers; mallards/wood ducks; and blacks/whites. The minimum amount of time necessary for a new species to form is about 10,000 years; human population groups have been separated for about 110,000 years. In reality there are actually four human species: Asian, Caucasian, Negroid, and mixed.

Nature proceeds in one of two directions -- either towards quality or towards quantity. In a harsh environment like Northern Europe, or Northern Asia nature shifts towards quality; all life forms in these regions are referred to as k-selected. In a milder environment like Sub-Saharan Africa or South America, nature shifts towards quantity; all life forms in these regions are referred to as r-selected. The average IQ of the Negroid population of Sub-Saharan Africa is 70. The average IQ of the Caucasian population of Europe is 103.

A person who has an IQ of 70 or below is considered to be retarded. So basically this means that half of the population of Sub-Saharan Africa is retarded. This is the reason for Africa's failure not colonialism, racism, lack of natural resources or money. No amount of money given to them by the IMF, United Nations, USA, or do-gooders in general will have any effect except for exacerbating the situation by creating exponential population growth. By the way, when was the last time you've heard of some do-gooder organization sending money to a middle class white family so they can have more children? Answer: never.

So what are some possible reasons for the declining birth rate of whites? The tax rate on the average middle-class white family in total is about 50%. So even if they'd like to have more children they can't afford to because they want to be responsible parents and be able to provide properly for the children that they do have. Blacks on the other hand can simply have as many children as they want and depend on the government or do-gooder organizations to care for their children. This is the main evolutionary strategy on behalf of blacks, quantity over quality. Another possible reason for the declining white birth rate is the constant stream of anti-white propaganda put out in the school system, on TV, in movies, in print media, and over the radio.

In the public school system white children are taught how evil and awful their ancestors were, and white children are given a sense of group guilt for all of the wrongs of the past. However anything that whites have done in the past which is considered to be good is taught as an individual act of a single person not attributable to the group. Conversely black children are taught to have a sense of group pride for historical accomplishments which are either imaginary or inflated. It is considered wonderful that we have things like "African American History Month", however if someone suggested that there should be a "European American History Month", that person would be denounced as a racist, hater, bigot, redneck, or mentally ill person.

MTV teaches white teenagers that "whites are basically lame but if they mimic blacks they can be sort of cool." Seventy-five percent (75%) of all rap music is bought by white teenagers so I guess the brainwashing has been effective. Blacks on TV are constantly portrayed as the inverse of what they are in reality such as: brain surgeons, rocket scientists, good Samaritans and everything else that whites apparently are not.

Blacks, Hispanics, Jews, and Asians are considered by the government to be a "protected class" -- any offensive remarks made by a white person which might offend this protected class is considered to be "hate speech." Affirmative Action gives preferences to minorities in job hiring, contracts, and admission to universities. Forced integration has destroyed the public school system. At one time the U.S. had the best elementary/secondary school system in the world, now it ranks near the bottom of the industrialized world. The bottom line of all this is basically that the government is providing a number of disincentives to white women who want to have white children. Because subconsciously she knows that her offspring will be at an inherent disadvantage for all of the aforementioned reasons.

Multiculturalism is really a code word for white genocide. The fewer whites there are the more multicultural it is and the better it is. So if you were to take this concept to its logical extreme, when there are no whites left at all we will have reached some sort of multicultural nirvana.



William Wilberforce

On Friday July 26th 1833 as he lay on his deathbed Wilberforce exclaimed: "Thank God that I have lived to witness the day in which England is willing to give £20 million for the abolishment of slavery." (What would that be worth today ?) He died three days later.

The Slavery Abolition Bill 1833 passed through the House of Lords, it received the Royal Assent (which means it became law) on 29 August 1833 and came into force on 1 August 1834. On that date slavery was abolished throughout the vast British Empire. The Act automatically applied as new possessions (principally in Africa) subsequently became part of the British Empire.

To know who rules over you. Simply find out who it is that you are not allowed to criticise.Voltaire

We, as White people, have been GAGGED!! Then bullied, insulted, demonised, and provoked, until we object and complain. We then get called *dirty names* like Nazi, Racist, White Extremist, etc, etc.

Our weak & corrupt Lib/Lab/Con Politicians are the problem. As of Jan 2021, the UK elections are years away. Check out Populism, and Nationalism ASAP. Become "WHITE WOKE" & Push Back.

Do it today, NOW!



William Wilberforce
On Friday July 26th 1833 as he lay on his deathbed Wilberforce exclaimed: "Thank God that I have lived to witness the day in which England is willing to give £20 million for the abolishment of slavery." (What would that be worth today ?)
He died three days later.

The Slavery Abolition Bill 1833 passed through the House of Lords, it received the Royal Assent (which means it became law) on 29 August 1833 and came into force on 1 August 1834. On that date slavery was abolished throughout the vast British Empire. The Act automatically applied as new possessions (principally in Africa) subsequently became part of the British Empire.

To know who rules over you. Simply find out who it is that you are not allowed to criticise.Voltaire

We, as White people, have been GAGGED!! Then bullied, insulted, demonised, and provoked, until we object and complain. We then get called *dirty names* like Nazi, Racist, White Extremist, etc, etc.

Our weak & corrupt Lib/Lab/Con Politicians are the problem. As of Jan 2021, the UK elections are years away. Check out Populism, and Nationalism ASAP. Become "WHITE WOKE" & Push Back. **Do it today, NOW!**

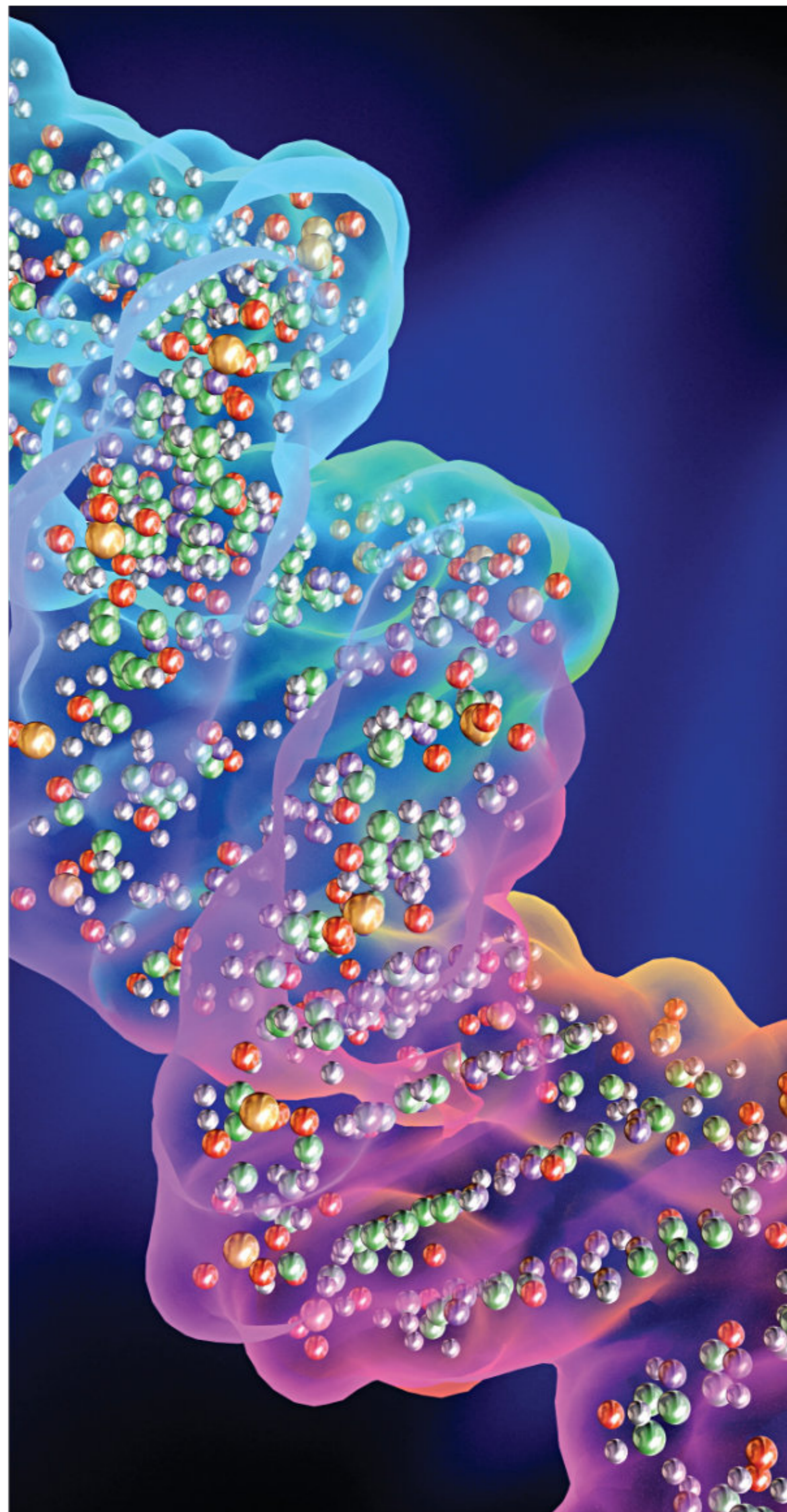

The idea of genetic inequality cannot be debated in public because of course it's racist. The word 'racist' has no value whatsoever. It has the same meaning as the word 'heretic' had during the Middle Ages. Following this type of reasoning, it really wasn't that important whether Galileo's theorem that the earth revolves around the sun is true or not, only that his heliocentrism went against official ideology.

There are other forces at work against us besides propaganda and government policy. In a sense, the white race has outsmarted itself by creating technology its enemies have used against it. Without mass agriculture there would be no exponential population growth in Third-World countries. Without modern transportation, the massive influx of Third-World immigration would be nearly impossible. With modern utilities every home has a year-round mild climate just like Sub-Saharan Africa. No one has to worry about storing food for the winter, just like in Sub-Saharan Africa. What we've done with modern technology is converted the environment of the entire planet into one that mimics Sub-Saharan Africa. This is the reason that Third-World genetics are expanding and First-World genetics are contracting: because our natural harsh climate has disappeared, so our genes which evolved in a harsh environment are no longer advantageous. The bad news for all of our Third-World friends is that once we disappear, all of our technology goes with us. This will probably result in a 99% reduction of their population.

Adolf Hitler predicted many of the problems we face today back in 1925 when he wrote Mein Kampf. This is why after he became the supreme leader he enacted the Nuremberg race laws in order to prevent the spread of Third-World genetics in Germany. Also the eugenics program was designed to prevent the increase in the number of white degenerates - a natural outcome if left unchecked in a technological society. Unfortunately Hitler lost the war against bolshevism and international Jewry. I look at it this way: Whenever we have blacks rioting in the streets or terrorist blowing up buildings, or Jews teaching white kids to hate themselves, or Hispanics invading our country, this is nothing less than Hitler's posthumous revenge on America.

ARYAN SPECIES



Adolf Hitler as a young art student. (Video frame)

This whole period is well overdue for re-examination. No other period in History has been so censored and lied about. **Why?**

**Adolf Hitler
The Greatest Story Never Told**

Video 6.5 hours long. MP4 file. This is a large document of 1.5 GB Best option is to download and view offline.

This video contains lots of Jaw Dropping information that we never get told, or that has been blatantly lied about. Note the truth about Jesse Owens !! **Open**

Mentioning the Unmentionable

Derek Turner speaks to Professor Richard Lynn.
Crime - Genetics - Race - Intelligence - Immigration.

From <https://www.derek-turner.com/> & <http://www.rlynn.co.uk>

THE ISSUES of ethnicity, race and immigration constitute the hottest of hot potatoes in today's politics: issues that generate more heat than light.

To try to ascertain some hard facts on the subject Right NOW! went to Professor RICHARD LYNN, Director of the Ulster Institute for Social Research, recognised as one of Britain's leading scientific authorities on ethnicity.

His controversial answers are bound to shock and offend many people, but Right NOW! believes the issue to be of such compelling importance that it is now necessary to talk openly about formerly 'taboo' subjects. Could you begin by telling us a little about yourself, your family and how you became interested in psychology, intelligence and genetics ?

Both my father and my maternal grandfather were biologists and plant breeders who had a good knowledge of genetics, so I was brought up with the idea that heredity is important. However, as a schoolboy at the Bristol Grammar School I was not greatly interested in biology. The subject that interested me most was history. I was fascinated by the struggles for power between individuals - the ambition to get "to the top of the slippery pole", as Disraeli put it; between social classes and religious sects that erupted in the English Civil War and the French Revolution; in the incessant warfare between nations, and the rise and fall of empires. I also came to realise the shortcomings of the analyses of great historical events offered by historians. At the age of 16 I concluded that the explanation for these events must lie in human psychology, and decided that this was the subject I would take up at university. I set my sights on Cambridge as the leading scientific university, took the scholarship examinations and was awarded a scholarship by King's College.

And how did your interests in psychology develop at Cambridge ?

I found psychology at Cambridge a bit disappointing. The interests of the department were narrowly experimental. However, I read widely and soon discovered the work on intelligence that had been done at University College in London by Charles Spearman and Cyril Burt, and the work on personality that Hans Eysenck was doing at the Institute of Psychiatry. I knew immediately that this was where my true interests lay, and although I stayed on at Cambridge to do my PhD, by the time I graduated I was a committed member of the London school.

How and why did you begin your studies on human intelligence ?

I spent the first few years of my academic career at the University of Exeter, where I worked on Eysenck's theory of personality. Although I was interested in

intelligence, I did not carry out research on it until the 1970s. In 1967 I moved to Dublin to a professorship at the Irish Economic and Social Research Institute. I became interested in the problem of national differences in economic growth. The miracle economy of the post world war years was Japan, and I wondered what could be the secret of the Japanese economic success. I read the work of economists on the question of national differences in rates of economic growth and I soon discovered that they hadn't the slightest idea why economic growth rates differed - any more than historians had any idea of the real causes of group conflict, warfare or the rise and fall of empires, as I had discovered as a school boy. In the 1970s it was well known in psychology that intelligence is a major determinant of social mobility and economic success among individuals, so I began to wonder whether intelligence might not also be a factor in the economic success of nations. No one had ever attempted to measure the intelligence in different nations, so there was no way of tackling this question. However, I was thinking about the issue and, as Louis Pasteur observed, "chance favours the prepared mind". Through chance I discovered that several American intelligence tests had been administered and standardised in Japan. I hired a translator to have the test manuals translated into English and from these I was able to calculate the average Japanese IQ. It came out at 106, 6 IQ points higher than the average of American whites. I published this result in 1977, noted that this was the highest IQ ever recorded for a population and argued that it probably reflected genetic superiority.

And how was the initial paper received ?

It was noted by people working on intelligence and was soon recorded in the standard textbooks, such as those by Hans Eysenck and Philip Vernon which appeared in 1979, and in subsequent textbooks.

Have you done any further work on the intelligence of Orientals ?

Yes, I have made this my specialism and have collected and calculated the IQs for a number of Oriental peoples including those in Hong Kong, Singapore, Taiwan, China, and Korea. I have found that these peoples invariably have average IQs a little higher than whites in the United States, Britain and Continental Europe. Their overall average is about 105. My work also stimulated Philip Vernon to make a study of the IQ of ethnic Japanese and Chinese in the United States, and he came to the same conclusion that their intelligence is about 5 IQ points higher than that of whites.

How have the environmentalists reacted to this work ?

The high IQ of Orientals is an irritant for them because they have argued that intelligence tests are craftily constructed by white middle class males to ensure that they score best on the tests, or alternatively that the tests simply reflect environmental advantages. As some of the Japanese who scored higher than whites had been born and brought up during the privations of World War Two and its aftermath, these explanations were obviously not credible. So some environmentalists have tried to nit-pick my results, but their criticisms do not stand up.

And how does the 5 IQ point advantage of Orientals compare with the intelligence level of blacks

My work on this question has consisted of examining the IQs of blacks in Africa.



William Wilberforce

On Friday July 26th 1833 as he lay on his deathbed Wilberforce exclaimed: "Thank God that I have lived to witness the day in which England is willing to give £20 million for the abolishment of slavery." (What would that be worth today ?)

He died three days later.

The Slavery Abolition Bill 1833 passed through the House of Lords, it received the Royal Assent (which means it became law) on 29 August 1833 and came into force on 1 August 1834. On that date slavery was abolished throughout the vast British Empire.

The Act automatically applied as new possessions (principally in Africa) subsequently became part of the British Empire.

To know who rules over you. Simply find out who it is that you are not allowed to criticise.Voltaire

We, as White people, have been GAGGED!! Then bullied, insulted, demonised, and provoked, until we object and complain. We then get called *dirty names* like Nazi, Racist, White Extremist, etc, etc.

Our weak & corrupt Lib/Lab/Con Politicians are the problem. As of Jan 2021, the UK elections are years away. Check out Populism, and Nationalism ASAP. Become "WHITE WOKE" & Push Back.

Do it today, NOW!



William Wilberforce

On Friday July 26th 1833 as he lay on his deathbed Wilberforce exclaimed: "Thank God that I have lived to witness the day in which England is willing to give £20 million for the abolishment of slavery." (What would that be worth today?)

He died three days later.

The Slavery Abolition Bill 1833 passed through the House of Lords, it received the Royal Assent (which means it became law) on 29 August 1833 and came into force on 1 August 1834. On that date slavery was abolished throughout the vast British Empire.

The Act automatically applied as new possessions (principally in Africa) subsequently became part of the British Empire.

To know who rules over you. Simply find out who it is that you are not allowed to criticise.Voltaire

We, as White people, have been GAGGED!! Then bullied, insulted, demonised, and provoked, until we object and complain. We then get called *dirty names* like Nazi, Racist, White Extremist, etc, etc.

Our weak & corrupt Lib/Lab/Con Politicians are the problem. As of Jan 2021, the UK elections are years away. Check out Populism, and Nationalism ASAP. Become "WHITE WOKE" & Push Back.

Do it today, NOW!

And how serious are these problems ?

They are very serious. All these problems have been identified for some time in the United States and have been well reviewed by Richard Herrnstein and Charles Murray in *The Bell Curve*. They have also appeared in Britain. For instance, official government figures have shown that in 1995 62 per cent of young black males are unemployed, as compared with about 18 per cent of whites. Black crime in Britain is about three times higher than white. The 1991 census showed that single motherhood among blacks was 51 per cent, about double that of whites.

Why should lower intelligence cause more crime ?

Most crimes are committed by people with low intelligence. This is partly because the unintelligent have less to lose by being caught because they generally have poor jobs, or are unemployed, and partly because they can't figure out so well the likelihood and consequences of being caught.

Isn't there something more to the race differences in crime ? Don't blacks commit crime more than whites even when they have the same IQ ?

Yes, this is true. It may be that the explanation for this is that blacks are led into crime through peer pressure. In addition one of the things Rushton has shown (*Race, Evolution and Behaviour*, J Philippe Rushton, Transaction Press, New Brunswick, 1994) is that blacks have high levels of testosterone, the male sex hormone that makes males aggressive, and this probably contributes to their high crime rate.

In *The Bell Curve*, (Ed: see RN, issue 7) Richard Herrnstein and Charles Murray estimated that the average IQ in the United States would decline to about 95 by the middle of the 21st century because of the growth in numbers of a low IQ non-European population.

Do you agree ?

Yes. Immigration into the United States is running at about 1.4 million annually. The great majority of these are Hispanics, most of whom are of mixed Spanish and American-Indian ancestry. Their average IQ is 92. There are also substantial numbers of blacks entering the United States from the Caribbean and Africa. They probably number about 150,000 a year. In the next century Hispanics and blacks will form an increasing percentage of the population and will become a majority in about 50 years' time. This will inevitably reduce the overall American IQ, as Herrnstein and Murray predict.

So what future do you see for the United States ?

It is impossible not to be pessimistic. It looks set to become like many of the Latin American countries where whites live in their own fortified housing estates while Hispanics hybridised with American Indians and blacks live in lawless shanty towns.

Do you think anything could be done to prevent this ?

It is probably too late. Theoretically all immigration into the United States could be stopped as from today, but the political problems of doing this are enormous. And there would still be a large amount of illegal immigration.

Hundreds of studies have been done of blacks in the United States, where their average IQ comes out at about 85. A few studies have been done of blacks in Britain, where their IQ is a little higher at around 89. This is probably because the more intelligent blacks migrated to Britain. But no-one had ever looked systematically at the intelligence level of African blacks. So in the late 1980s I made a search for all the studies that had been done on this question, most of them published in very obscure publications. I found 11 studies on representative samples and estimated that the average IQ of African blacks is approximately 70.

Isn't this very low ?

Yes, those with IQs of below 70 are considered in Western countries as mentally retarded.

Does this not argue rather poorly for the potential of black Africans for democracy and economic development ?

It does. The negative economic growth of recent years in much of sub-Saharan Africa is likely to continue.

Why should there be this difference between blacks in Africa and in the United States ?

There are probably two reasons. The first is that the great majority of American blacks have some white ancestry and this raises their intelligence. The second is that American blacks enjoy a high standard of living, and this has given an environmental boost to their intelligence.

Have you explored the reasons for these racial differences in intelligence ?

I began to think about this question in the mid-1980s. I concluded that the higher intelligence of the Oriental and Caucasian peoples was probably an evolutionary adaptation to the problems of survival in cold northern environments. Human beings first evolved in tropical Africa where survival was relatively easy. Then some of them migrated northwards into Eurasia and they found life wasn't nearly so simple. They had to survive through long cold winters, build shelters, make clothing and fires, and hunt animals in order to survive. They had to become more intelligent to deal with these problems, or they would have died out. The climatic conditions were a bit more severe for the Oriental peoples in north east Asia than they were in Europe, so that is why Orientals evolved slightly higher intelligence.

What are the grounds on which you believe that IQ is genetically determined ?

It has been known since the 1930s from twin studies that intelligence is mainly under genetic control. In addition, the blackwhite difference in intelligence has been found universally, in the United States, Britain, the Caribbean and in Africa. There is also solid evidence that, on average, blacks have smaller brains than whites.

What do you see as the principal social problems caused by low intelligence levels ?

Poor educational attainment, poor vocational skills, high unemployment, high rates of crime and single motherhood. Low intelligence is a major causal factor in all these social pathologies.

Is there nothing that can be done about the decline of the United States to Latin American status ?

I think the only solution lies in the breakup of the United States. Blacks and Hispanics are concentrated in the Southwest, the Southeast and the East, but the Northwest and the far Northeast, Maine, Vermont and upstate New York have a large predominance of whites. I believe these predominantly white states should declare independence and secede from the Union. They would then enforce strict border controls and provide minimum welfare, which would be limited to citizens. If this were done, white civilisation would survive within this handful of states.

Do you think this would be feasible ?

Not yet. Both the political will and the understanding of the seriousness of the problem are lacking. Things will have to get a good deal worse before they can get better.

What are your views about immigration into Britain ?

Britain has the same problem of a significant black minority with high fertility and the continuing immigration of illegals and bogus refugees. The numbers are much fewer than in the United States, but will grow in the years that lie ahead. There is the same problem in mainland Europe. The immigration of Third World peoples should be much more tightly controlled.

What about the immigration of Indians and Pakistanis into Britain ?

These peoples have about the same intelligence level as whites, as would be expected because they are Caucasians. They are not a genetic problem.

What is your general view of the future of Western civilisation ?

It will become increasingly torn apart by crime and racial conflict. World leadership will pass to the Far East, to Japan, Korea and, in due course, to China. These countries will remain racially homogenous and hence free of racial conflict, and their high intelligence levels will secure them world domination.



Professor Richard Lynn

About Richard Lynn . . . <http://www.rlynn.co.uk>

Born February 1930.

Professor of Psychology, University of Ulster. 1972-1995.

Lecturer in Psychology, University of Exeter, 1956-67.

Winner of US Mensa Award for Excellence, 1985 and 1988, for work on intelligence.

Published works -

1966 Attention, Arousal and the Orientation Reaction

1969 The Irish Braindrain

1969 The Universities and the Business Community

1971 Personality and National Character

1972 An Introduction to the Study of Personality

1974 The Entrepreneur

1981 Dimensions of Personality

1987 Educational Achievement in Japan

1991 The Secret of the Miracle Economy

Numerous articles on personality, intelligence and social psychology

About Derek Turner ... <https://www.derek-turner.com/>:

I write novels - three to date - and have contributed arts reviews, book reviews, political commentaries and travelogues to publications like the Times, Sunday Telegraph, Daily Mail, the Literary Review, Country Life, Spectator Australia, New Welsh Review, Spiked, Chronicles, Modern Age, and Junge Freiheit.

My first novel, Sea Changes (2012) deals with mass immigration and its consequences for both the immigrants and an often unwelcoming, unwilling England.

My second, Displacement (2015), is set in Deptford, and follows the exploits of a bright working class boy as he rises literally and metaphorically above the inner city through the dangerous sport of parkour.

A Modern Journey concerns Ambrose, a wild-eyed Holy Fool, as he careers through modern Dublin on a peculiar religious quest that brings him into often comical collision with everyone and everything

Books by Derek Turner on Amazon

https://www.amazon.com/Derek-Turner/e/B01GYLQUP2?ref_=pe_1724030_132998060



Derek Turner



William Wilberforce

On Friday July 26th 1833 as he lay on his deathbed Wilberforce exclaimed: "Thank God that I have lived to witness the day in which England is willing to give £20 million for the abolishment of slavery." (What would that be worth today ?)

He died three days later.

The Slavery Abolition Bill 1833 passed through the House of Lords, it received the Royal Assent (which means it became law) on 29 August 1833 and came into force on 1 August 1834. On that date slavery was abolished throughout the vast British Empire.

The Act automatically applied as new possessions (principally in Africa) subsequently became part of the British Empire.

To know who rules over you. Simply find out who it is that you are not allowed to criticise.Voltaire

We, as White people, have been GAGGED!! Then bullied, insulted, demonised, and provoked, until we object and complain. We then get called *dirty names* like Nazi, Racist, White Extremist, etc, etc.

Our weak & corrupt Lib/Lab/Con Politicians are the problem. As of Jan 2021, the UK elections are years away. Check out Populism, and Nationalism ASAP. Become "WHITE WOKE" & Push Back.

Do it today, NOW!

JEWS explain WHY they bring millions of Muslims and African immigrants to Europe

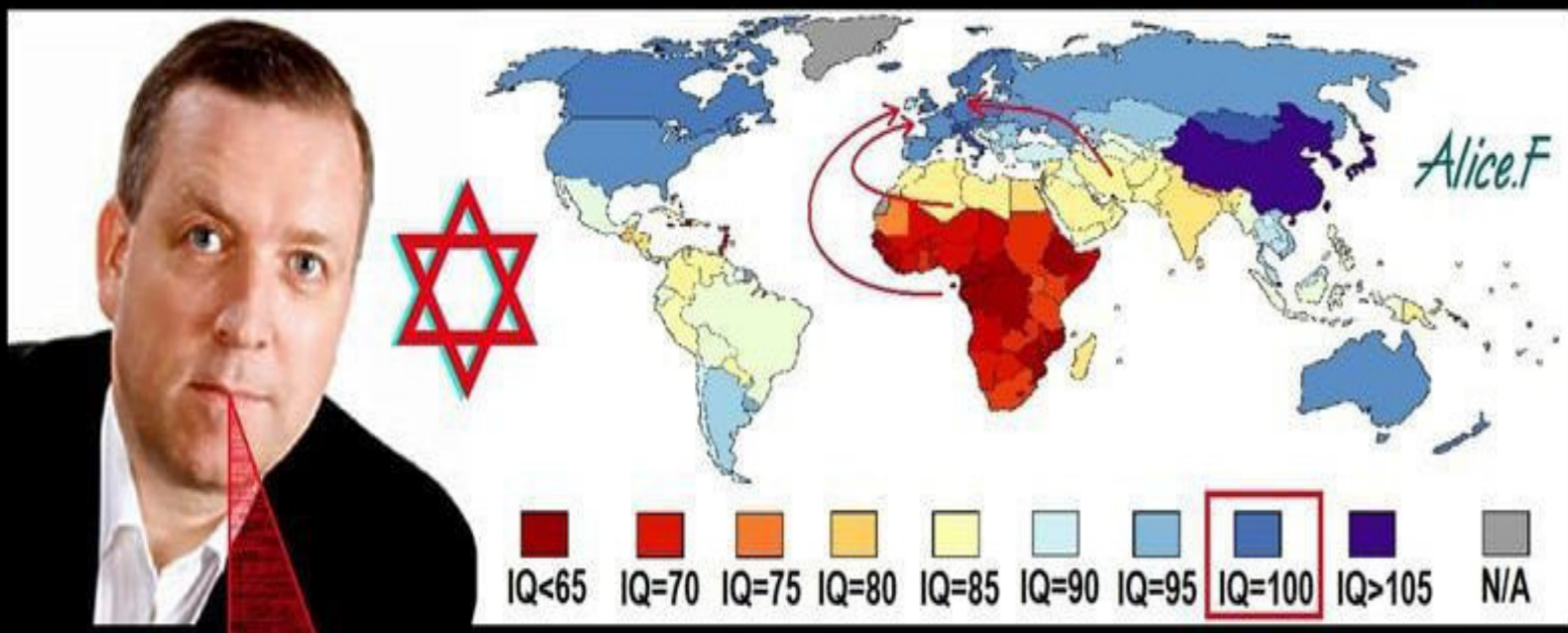

“The ultimate goal is the forcible-coordination of all countries of the world: That shall be achieved by **mixing the races with the goal to create a light brown race in Europe.** For that reason 1.5 million immigrants from the third world shall migrate to Europe every year. **The result would be a population with an AVERAGE IQ OF 90 that is so dumb to grasp anything but intelligent enough to work.** The European countries would **NEVER AGAIN BE COMPETITORS** in the struggle for global domination and a multiple millennia old culture **would be destroyed.** Irrational people who will fight against this “mingling of races”, and put up any resistance against the global world order, **should be killed.**” ~ Thomas P.M. Barnett, *JEW*, director of the Israeli military consultancy ‘Wikistrat’ in his book ‘The Pentagon’s New Map’, 2004 *Alice.F*

Search: P M Barnett The Pentagons New Map

The Barnett Plan a Review by Winter Watch

<https://www.winterwatch.net/2019/11/the-barnett-plan-the-pentagons-dead-end-map-for-neocon-globalism/>

The Book by P M Barnett and Reviews on Amazon

<https://www.amazon.com/Pentagons-New-Map-Twenty-First-Century/dp/0425202399>

Videos - Immigrant Experience In Israel



You're married to a Nigger Get Out !!
Israel's New Racism: The Persecution of African Migrants in the Holy Land. About 60,000 African migrants have arrived in Israel since 2006.

[Open](#)



Israel plans to force out African immigrants. Israel began implementing a plan to force tens of thousands of African migrants out of the country by April, threatening to arrest those who stay.

[Open](#)



Israel to pay a 'Bounty' of \$5,000 and give guns. To get rid of African immigrants. Israel was the main driver behind the 1951 UN Convention on the Rights of Refugees, but after signing it, it has never respected the rights of refugees.

[Open](#)



Israel extends its high-tech barriers. Israel is closing gaps in its controversial West Bank barrier and building high-tech fences around its borders.

[Open](#)



William Wilberforce
On Friday July 26th 1833 as he lay on his deathbed Wilberforce exclaimed: "Thank God that I have lived to witness the day in which England is willing to give £20 million for the abolishment of slavery." (What would that be worth today ?) He died three days later.

The Slavery Abolition Bill 1833 passed through the House of Lords, it received the Royal Assent (which means it became law) on 29 August 1833 and came into force on 1 August 1834. On that date slavery was abolished throughout the vast British Empire. The Act automatically applied as new possessions (principally in Africa) subsequently became part of the British Empire.

To know who rules over you. Simply find out who it is that you are not allowed to criticise.Voltaire

We, as White people, have been GAGGED!! Then bullied, insulted, demonised, and provoked, until we object and complain. We then get called *dirty names* like Nazi, Racist, White Extremist, etc, etc.

Our weak & corrupt Lib/Lab/Con Politicians are the problem. As of Jan 2021, the UK elections are years away. Check out Populism, and Nationalism ASAP. Become "WHITE WOKE" & Push Back.

Do it today, NOW!

Videos - Immigration Into Britain

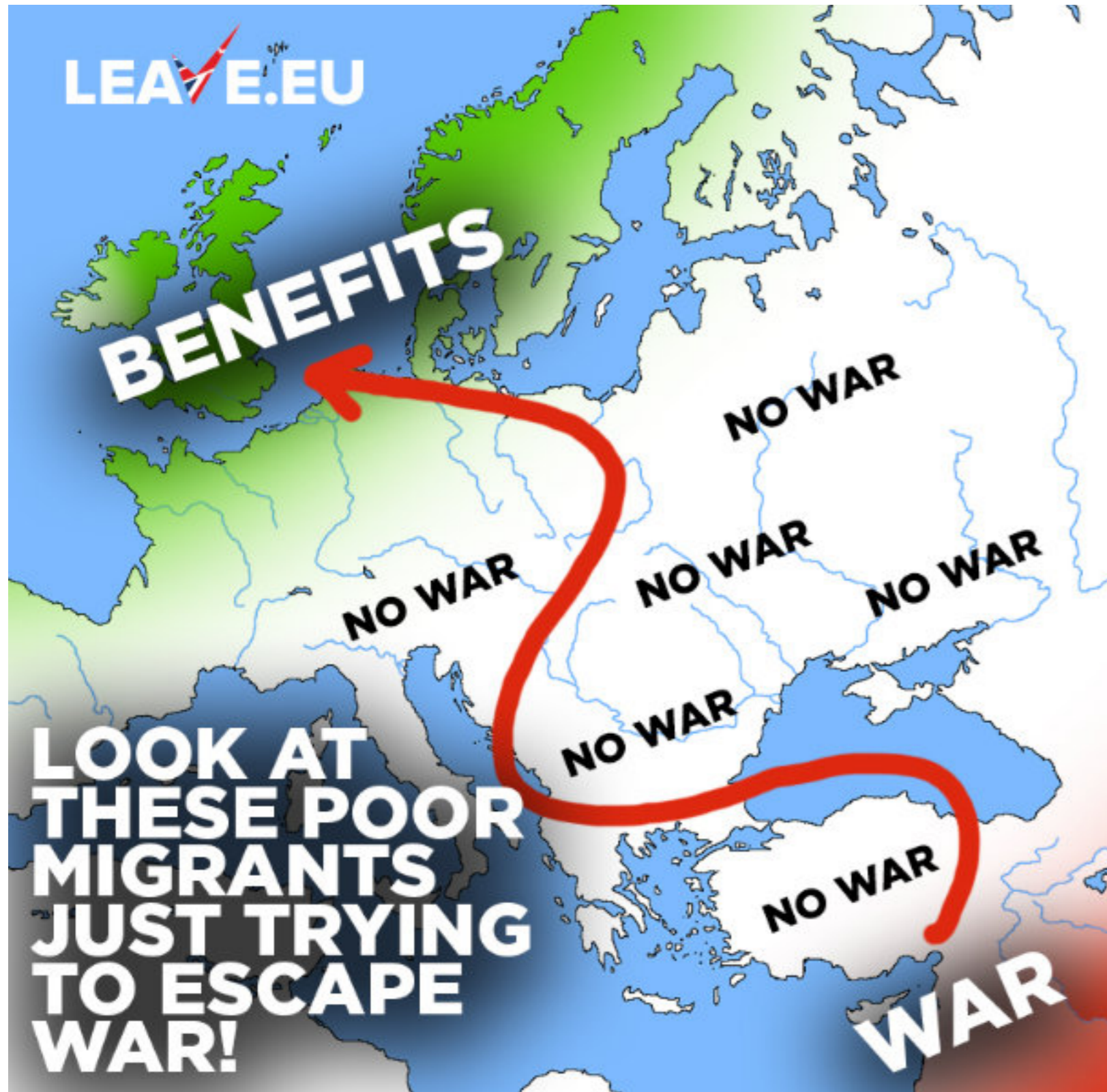

The 'Barcelona Declaration' of 1995. Europe's fate was decided long ago. Do you ever wonder why our leaders and authorities stand idly by while our countries are decimated by illegal economic migrants ?

[Open](#)



Europe is now going to be flooded with Black Africans from Sub Saharan Africa.

Watch this video and then search out the 'Marakesh Declaration'

[Open](#)



Immigration is all about cheap labour. Indigenous people are now a minority in their own capital city.

This is a wake up call not just for London, but for the whole of Britain.

[Open](#)



WAKE UP WHITE MAN !! WAKE UP !! NO ROOM FOR CONFUSION HERE

Ash Sarkar is a Left Wing activist and journalist contributor to the Guardian, Observer, etc.

[Open](#)



UK Pakistani Inbreeding. The UK Pakistani population is about 3% of the total UK population.

But produces 30% of all births with genetic illness or defects.

[Open](#)



Leftist Jews in America, behind immigration into Europe, of people who want to kill us. Do not speak of it or complain, you will be prosecuted for "Anti Semitism".

[Open](#)



William Wilberforce
On Friday July 26th 1833 as he lay on his deathbed Wilberforce exclaimed: "Thank God that I have lived to witness the day in which England is willing to give £20 million for the abolishment of slavery." (What would that be worth today ?) He died three days later.

The Slavery Abolition Bill 1833 passed through the House of Lords, it received the Royal Assent (which means it became law) on 29 August 1833 and came into force on 1 August 1834. On that date slavery was abolished throughout the vast British Empire. The Act automatically applied as new possessions (principally in Africa) subsequently became part of the British Empire.

To know who rules over you. Simply find out who it is that you are not allowed to criticise.Voltaire

We, as White people, have been GAGGED!! Then bullied, insulted, demonised, and provoked, until we object and complain. We then get called *dirty names* like Nazi, Racist, White Extremist, etc, etc.

Our weak & corrupt Lib/Lab/Con Politicians are the problem. As of Jan 2021, the UK elections are years away. Check out Populism, and Nationalism ASAP. Become "WHITE WOKE" & Push Back.

Do it today, NOW!

[More Educational Videos](#)

Videos - The Beginnings by Rudyard Kipling

1 - It was not part of their blood,
It came to them very late
With long arrears to make good,
When the English began to hate.

2 - They were not easily moved,
They were icy-willing to wait
Till every count should be proved,
Ere the English began to hate.

3 - Their voices were even and low,
Their eyes were level and straight.
There was neither sign nor show,
When the English began to hate.

4 - It was not preached to the crowd,
It was not taught by the State.
No man spoke it aloud,
When the English began to hate.

5 - It was not suddenly bred,
It will not swiftly abate,
Through the chill years ahead,
When time shall count from the date,
That the English began to hate.



Tough talking FRAUDS of British Radio

Just another Fraud !

The best way to control the opposition, is to lead it ourselves - Lenin

Open

Professor Kai Murros
England Is At WAR



Professor Kai Murros
[England Is At WAR](#)

"The low intensity ethnic warfare your elites have waged against you for decades, has now reached new levels"

Open

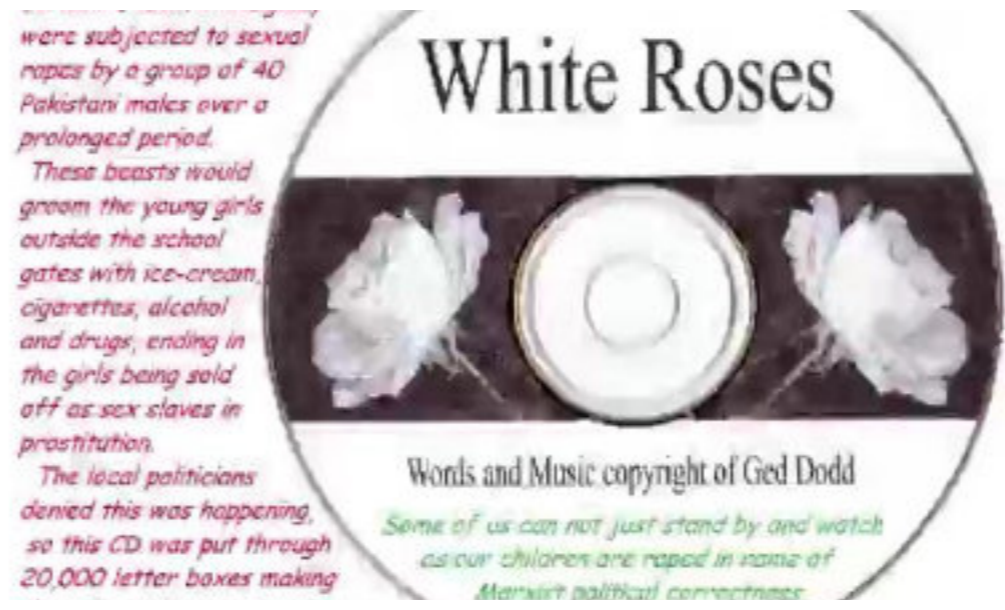

In 2004/5 the local girls in the Yorkshire town of Keighley were subjected to sexual rapes by a group of about 40 Pakistani males over a prolonged period. **The local politicians denied this was happening.**

Open

We stabbed your White boy !!

15 Minute video.

Just some of the White victims that you hardly, or never, heard of.

Open

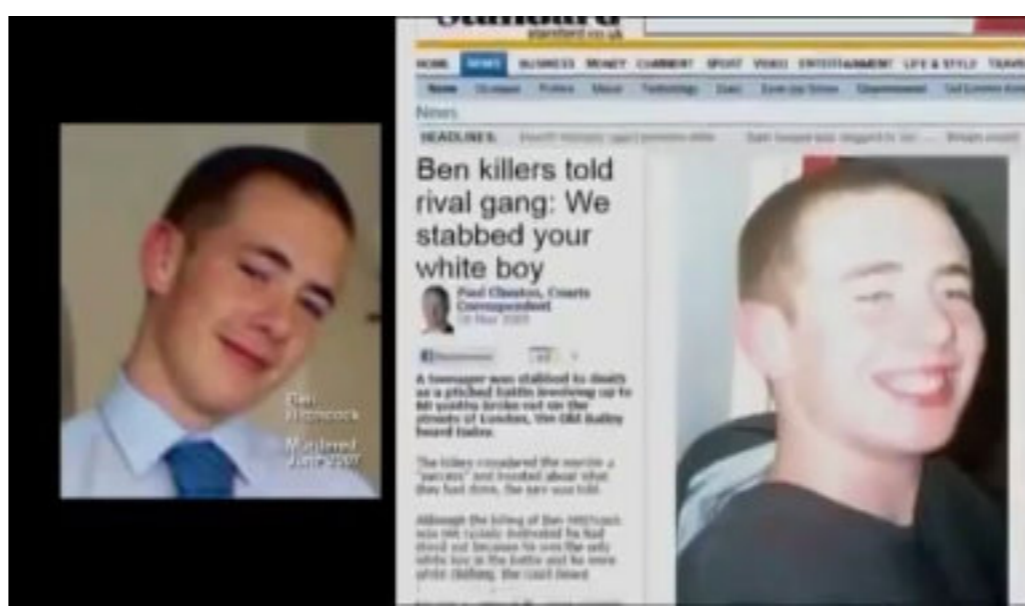

We Are Generation Identitaire.

French youth declare war on the generation who betrayed them.

Open

[More Educational Videos](#)



William Wilberforce

On Friday July 26th 1833 as he lay on his deathbed Wilberforce exclaimed: "Thank God that I have lived to witness the day in which England is willing to give £20 million for the abolishment of slavery." (What would that be worth today ?) He died three days later.

The Slavery Abolition Bill 1833 passed through the House of Lords, it received the Royal Assent (which means it became law) on 29 August 1833 and came into force on 1 August 1834.

On that date slavery was abolished throughout the vast British Empire. The Act automatically applied as new possessions (principally in Africa) subsequently became part of the British Empire.

To know who rules over you. Simply find out who it is that you are not allowed to criticise.Voltaire

We, as White people, have been GAGGED!! Then bullied, insulted, demonised, and provoked, until we object and complain. We then get called *dirty names* like Nazi, Racist, White Extremist, etc, etc.

Our weak & corrupt Lib/Lab/Con Politicians are the problem. As of Jan 2021, the UK elections are years away. Check out Populism, and Nationalism ASAP. Become "WHITE WOKE" & Push Back.

Do it today, NOW! 116



William Wilberforce
On Friday July 26th 1833 as he lay on his deathbed Wilberforce exclaimed: "Thank God that I have lived to witness the day in which England is willing to give £20 million for the abolishment of slavery." (What would that be worth today ?)
He died three days later.

The Slavery Abolition Bill 1833 passed through the House of Lords, it received the Royal Assent (which means it became law) on 29 August 1833 and came into force on 1 August 1834. On that date slavery was abolished throughout the vast British Empire. The Act automatically applied as new possessions (principally in Africa) subsequently became part of the British Empire.

To know who rules over you. Simply find out who it is that you are not allowed to criticise.Voltaire

We, as White people, have been GAGGED!! Then bullied, insulted, demonised, and provoked, until we object and complain. We then get called *dirty names* like Nazi, Racist, White Extremist, etc, etc.

Our weak & corrupt Lib/Lab/Con Politicians are the problem. As of Jan 2021, the UK elections are years away. Check out Populism, and Nationalism ASAP. Become "WHITE WOKE" & Push Back.

Do it today, NOW!

reconcile evidence of racial differences with a more sophisticated understanding of equality and opportunity. Or you can fight the evidence and hope it doesn't break your faith.

I'm for reconciliation. Later this week, I'll make that case. But if you choose to fight the evidence, here's what you're up against. Among white Americans, the average IQ, as of a decade or so ago, was 103. Among Asian-Americans, it was 106. Among Jewish Americans, it was 113. Among Latino Americans, it was 89. Among African-Americans, it was 85. Around the world, studies find the same general pattern: whites 100, East Asians 106, sub-Saharan Africans 70. One IQ table shows 113 in Hong Kong, 110 in Japan, and 100 in Britain. White populations in Australia, Canada, Europe, New Zealand, South Africa, and the United States score closer to one another than to the worldwide black average. It's been that way for at least a century.

Remember, these are averages, and all groups overlap. You can't deduce an individual's intelligence from her ethnicity. The only thing you can reasonably infer is that anyone who presumes to rate your IQ based on the color of your skin is probably dumber than you are.

So, what should we make of the difference in averages?

We don't like to think IQ is mostly inherited. But we've all known families who are smarter than others. Twin and sibling studies, which can sort genetic from environmental factors, suggest more than half the variation in IQ scores is genetic. A task force report from the American Psychological Association indicates it might be even higher. The report doesn't conclude that genes explain racial gaps in IQ. But the tests on which racial gaps are biggest happen to be the tests on which genes, as measured by comparative sibling performance, exert the biggest influence.

How could genes cause an IQ advantage? The simplest pathway is head size. I thought head measurement had been discredited as Eurocentric pseudoscience. I was wrong. In fact, it's been bolstered by MRI. On average, Asian-American kids have bigger brains than white American kids, who in turn have bigger brains than black American kids. This is true even though the order of body size and weight runs in the other direction. The pattern holds true throughout the world and persists at death, as measured by brain weight.

According to twin studies, 50 percent to 90 percent of variation in head size and brain volume is genetic. And when it comes to IQ, size matters. The old science of head measurements found a 20 percent correlation of head size with IQ. The new science of MRI finds at least a 40 percent correlation of brain size with IQ. One analysis calculates that brain size could easily account for five points of the black-white IQ gap.

I know, it sounds crazy. But if you approach the data from other directions, you get the same results. The more black and white scores differ on a test, the more performance on that test correlates with head size and "g," a measure of the test's emphasis on general intelligence. You can debate the reality of g, but you can't debate the reality of head size. And when you compare black and white kids who score the same on IQ tests, their average difference in head circumference is zero.

Scientists have already identified genes that influence brain size and vary by

Race, Genes And Intelligence By William Saletan

From <https://renew.com/>

"Among white Americans, the average IQ, as of a decade or so ago, was 103. Among Asian-Americans, it was 106. Among Jewish Americans, it was 113. Among Latino Americans, it was 89. Among African-Americans, it was 85. Around the world, studies find the same general pattern: whites 100, East Asians 106, sub-Saharan Africans 70. One IQ table shows 113 in Hong Kong, 110 in Japan, and 100 in Britain. White populations in Australia, Canada, Europe, New Zealand, South Africa, and the United States score closer to one another than to the worldwide black average. It's been that way for at least a century."

"We hold these truths to be self-evident, that all men are created equal, that they are endowed by their Creator with certain unalienable Rights"

- Declaration of Independence

Last month, James Watson, the legendary biologist, was condemned and forced into retirement after claiming that African intelligence wasn't "the same as ours." "Racist, vicious and unsupported by science," said the Federation of American Scientists. "Utterly unsupported by scientific evidence," declared the U.S. government's supervisor of genetic research. The New York Times told readers that when Watson implied "that black Africans are less intelligent than whites, he hadn't a scientific leg to stand on."

I wish these assurances were true. They aren't. Tests do show an IQ deficit, not just for Africans relative to Europeans, but for Europeans relative to Asians. Economic and cultural theories have failed to explain most of the pattern, and there's strong preliminary evidence that part of it is genetic. It's time to prepare for the possibility that equality of intelligence, in the sense of racial averages on tests, will turn out not to be true.

If this suggestion makes you angry-if you find the idea of genetic racial advantages outrageous, socially corrosive, and unthinkable-you're not the first to feel that way. Many Christians are going through a similar struggle over evolution. Their faith in human dignity rests on a literal belief in Genesis. To them, evolution isn't just another fact; it's a threat to their whole value system. As William Jennings Bryan put it during the Scopes trial, evolution meant elevating "supposedly superior intellects," "eliminating the weak," "paralyzing the hope of reform," jeopardizing "the doctrine of brotherhood," and undermining "the sympathetic activities of a civilized society."

The same values-equality, hope, and brotherhood-are under scientific threat today. But this time, the threat is racial genetics, and the people struggling with it are liberals. Evolution forced Christians to bend or break. They could insist on the Bible's literal truth and deny the facts, as Bryan did. Or they could seek a subtler account of creation and human dignity. Today, the dilemma is yours. You can try to

continent. Whether these play a role in racial IQ gaps, nobody knows. But we should welcome this research, because any genetic hypothesis about intelligence ought to be clarified and tested.

Critics think IQ tests are relative-i.e., they measure fitness for success in our society, not in other societies. "In a hunter-gatherer society, IQ will still be important, but if a hunter cannot shoot straight, IQ will not bring food to the table," argues psychologist Robert Sternberg. "In a warrior society physical prowess may be equally necessary to stay alive." It's a good point, but it bolsters the case for a genetic theory. Nature isn't stupid. If Africans, Asians, and Europeans evolved different genes, the reason is that their respective genes were suited to their respective environments.

In fact, there's a mountain of evidence that differential evolution has left each population with a balance of traits that could be advantageous or disadvantageous, depending on circumstances. The list of differences is long and intricate. On average, compared with whites, blacks mature more quickly in the womb, are born earlier, and develop teeth, strength, and dexterity earlier. They sit, crawl, walk, and dress themselves earlier. They reach sexual maturity faster, and they have better eyesight. On each of these measures, East Asians lag whites and blacks. In exchange, East Asians get longer lives and bigger brains.

How this happened isn't clear. Everyone agrees that the three populations separated 40,000 to 100,000 years ago. Even critics of racial IQ genetics accept the idea that through natural selection, environmental differences may have caused abilities such as distance running to become more common in some populations than in others. Possibly, genes for cognitive complexity became so crucial in some places that nature favored them over genes for developmental speed and vision. If so, fitness for today's world is mostly dumb luck. If we lived in a savannah, kids programmed to mature slowly and grow big brains would be toast. Instead, we live in a world of zoos, supermarkets, pediatricians, pharmaceuticals, and information technology. Genetic advantages, in other words, are culturally created.

Not that that's much consolation if you're stuck in the 21st century with a low IQ. Tomorrow we'll look at some of the arguments against the genetic theory.

PART TWO

Yesterday, we looked at evidence for a genetic theory of racial differences in IQ. Today let's look at some of the arguments against it. Again, I'm drawing heavily on a recent exchange of papers published by the American Psychological Association.

One objection is that IQ tests are racially biased. This is true in the broadest sense: On average, African and Asian kids have different advantages, and IQ tests focus on the things at which more Asian kids have the edge. But in the narrower sense of testing abilities that pay off in the modern world, IQ tests do their job. They accurately predict the outcomes of black and white kids at finishing high school, staying employed, and avoiding poverty, welfare, or jail. They also accurately predict grades and job performance in modern Africa. The SAT, GRE, and tests in the private sector and the armed forces corroborate the racial patterns on IQ tests. Kids of different backgrounds find the same questions easy or hard. Nor do tests

always favor a country's ethnic majority. In Malaysia, Chinese and Indian minorities outscore Malays.

If the tests aren't racist, some critics argue, then society is. That's true, in the sense that racism persists. But that alone can't account for the patterns in IQ scores. Why do blacks in the white-dominated United States score 15 points higher than blacks in black-dominated African countries, including countries that have been free of colonial rule for half a century? And why do Asian-Americans outscore white Americans?

Another common critique is that race is a fuzzy concept. By various estimates, 20 percent to 30 percent of the genes in "black" Americans actually came from Europe. Again, it's a good point, but it bolsters the case for a genetic explanation. Black Americans, like "colored" South Africans, score halfway between South African blacks and whites on IQ tests. The lowest black IQ averages in the United States show up in the South, where the rate of genetic blending is lowest. There's even some biological evidence: a correlation between racial "admixture" and brain weight. Reading about studies of "admixture" is pretty nauseating. But the nausea doesn't make the studies go away.

My first reaction, looking at this pattern, was that if the highest-scoring blacks are those who have lighter skin or live in whiter countries, the reason must be their high socioeconomic status relative to other blacks. But then you have to explain why, on the SAT, white kids from households with annual incomes of \$20,000 to \$30,000 easily outscore black kids from households with annual incomes of \$80,000 to \$100,000. You also have to explain why, on IQ tests, white kids of parents with low incomes -and low IQs outscore black kids of parents with high incomes and high IQs. Or why Inuits and Native Americans outscore American blacks.

The current favorite alternative to a genetic explanation is that black kids grow up in a less intellectually supportive culture. This is a testament to how far the race discussion has shifted to the right. Twenty years ago, conservatives were blaming culture, while liberals blamed racism and poverty. Now liberals are blaming culture because the emerging alternative, genetics, is even more repellent.

The best way to assess the effects of culture and socioeconomic status is to look at trans-racial adoptions, which combine one race's genes with another's environment. Among Asian-American kids, biological norms seem to prevail. In one study, kids adopted from Southeast Asia, half of whom had been hospitalized for malnutrition, outscored the U.S. IQ average by 20 points. In another study, kids adopted from Korea outscored the U.S. average by two to 12 points, depending on their degree of malnutrition. In a third study, Korean kids adopted in Belgium outscored the Belgian average by at least 10 points, regardless of their adoptive parents' socioeconomic status.

Studies of African-American kids are less clear. One looked at children adopted into white upper-middle class families in Minnesota. The new environment apparently helped: On average, the kids exceeded the IQ norms for their respective populations. However, it didn't wipe out racial differences. Adopted kids with two white biological parents slightly outscored kids with one black biological parent, who in turn significantly outscored kids with two black biological parents. The most plausible environmental explanation for this discrepancy is that the half-



William Wilberforce

On Friday July 26th 1833 as he lay on his deathbed Wilberforce exclaimed: "Thank God that I have lived to witness the day in which England is willing to give £20 million for the abolishment of slavery." (What would that be worth today ?)

He died three days later.

The Slavery Abolition Bill 1833 passed through the House of Lords, it received the Royal Assent (which means it became law) on 29 August 1833 and came into force on 1 August 1834. On that date slavery was abolished throughout the vast British Empire.

The Act automatically applied as new possessions (principally in Africa) subsequently became part of the British Empire.

To know who rules over you. Simply find out who it is that you are not allowed to criticise.Voltaire

We, as White people, have been GAGGED!! Then bullied, insulted, demonised, and provoked, until we object and complain. We then get called *dirty names* like Nazi, Racist, White Extremist, etc, etc.

Our weak & corrupt Lib/Lab/Con Politicians are the problem. As of Jan 2021, the UK elections are years away. Check out Populism, and Nationalism ASAP. Become "WHITE WOKE" & Push Back.

Do it today, NOW!



William Wilberforce

On Friday July 26th 1833 as he lay on his deathbed Wilberforce exclaimed: "Thank God that I have lived to witness the day in which England is willing to give £20 million for the abolishment of slavery." (What would that be worth today ?)

He died three days later.

The Slavery Abolition Bill 1833 passed through the House of Lords, it received the Royal Assent (which means it became law) on 29 August 1833 and came into force on 1 August 1834. On that date slavery was abolished throughout the vast British Empire.

The Act automatically applied as new possessions (principally in Africa) subsequently became part of the British Empire.

To know who rules over you. Simply find out who it is that you are not allowed to criticise.Voltaire

We, as White people, have been GAGGED!! Then bullied, insulted, demonised, and provoked, until we object and complain. We then get called *dirty names* like Nazi, Racist, White Extremist, etc, etc.

Our weak & corrupt Lib/Lab/Con Politicians are the problem. As of Jan 2021, the UK elections are years away. Check out Populism, and Nationalism ASAP. Become "WHITE WOKE" & Push Back.

Do it today, NOW!

black kids (in terms of their number of black biological parents) were treated better than the all-black kids. But the study shot down that theory. Twelve of the half-black kids were mistakenly thought by their adoptive parents to be all-black. That made no difference. They scored as well as the other half-black kids.

In Germany, a study of kids fathered by foreign soldiers and raised by German women found that kids with white biological dads scored the same as kids with biological dads of "African" origin. Hereditarians (scholars who advocate genetic explanations) complain that the sample was skewed because at least 20 percent of the "African" dads were white North Africans. I find that complaint pretty interesting, since it implies that North Africans are a lot smarter than other "whites." Their better critique is that the pool of blacks in the U.S. military had already been filtered by IQ tests. Even environmentalists (scholars who advocate nongenetic explanations) concede that this filter radically distorted the numbers. But again, the complaint teaches a lesson: In any nonrandom pool of people, you can't deduce even average IQ from race. Other studies lend support to both sides. In one study, half-black kids scored halfway between white and black kids, but kids with white moms and black dads (biologically speaking) scored nine points higher than kids with black moms and white dads. In another study, black kids adopted into white middle-class families scored 13 points higher than black kids adopted into black middle-class families, and both groups outscored the white average.

Each camp points out flaws in the other's studies, and the debate is far from over. But when you boil down the studies, they suggest three patterns. One, better environments produce better results. Two, moms appear to make a difference, environmentally and biologically. (Their biological influence could be hormonal or nutritional rather than genetic.) Three, underneath those factors, a racial gap persists. One problem with most of the adoption studies is that as a general rule, genetic differences in IQ tend to firm up in adolescence. And in the only study that persisted to that point (the one in Minnesota), kids scored on average according to how many of their biological parents were black.

The best argument against genetics isn't in these studies. It's in data that show shrinkage of the black-white IQ gap over time. From these trends, environmentalists conclude that the gap is closing to zero. Hereditarians read the data differently. They agree that the gap closed fractionally in the middle decades of the 20th century, but they argue that scores in the last two to three decades show no improvement.

I've been soaking my head in each side's computations and arguments. They're incredibly technical. Basically, the debate over the IQ surge is a lot like the debate over the Iraq troop surge, except that the sides are reversed. Here, it's the liberals who are betting on the surge, while the conservatives dismiss it as illogical and doomed. On the one hand, the IQ surge is hugely exciting. If it closes the gap to zero, it moots all the putative evidence of genetic barriers to equality. On the other hand, the case for it is as fragile as the case for the Iraq surge. You hope it pans out, but you can't see why it would, given that none of the complicating factors implied by previous data has been adequately explained or taken into account. Furthermore, to construe meaningful closure of the IQ gap in the last 20 years, you have to do a lot of cherry-picking, inference, and projection. I have a hard time explaining why I should go along with those tactics when it comes to IQ but not when it comes to Iraq.

When I look at all the data, studies, and arguments, I see a prima facie case for partial genetic influence. I don't see conclusive evidence either way in the adoption studies. I don't see closure of the racial IQ gap to single digits. And I see too much data that can't be reconciled with the surge or explained by current environmental theories. I hope the surge surprises me. But in case it doesn't, I want to start thinking about how to be an egalitarian in an age of genetic difference, even between races. More on that tomorrow.

PART THREE

Why write about this topic? Why hurt people's feelings? Why gratify bigots?

Because truth matters. Because the truth isn't as bad as our ignorant, half-formed fears and suspicions about it. And because you can't solve a problem till you understand it.

Two days ago, I said we could fight the evidence of racial differences in IQ, or we could accept it. Yesterday, I outlined the difficulty of fighting it. What happens if we accept it? Can we still believe in equality?

Let's look past our fears and caricatures and see what the evidence actually teaches us.

1. Individual IQ can't be predicted from race. According to the data, at least 15 percent to 20 percent of black Americans exceed the average IQ of white Americans. If you think it's safe to guess that a white job applicant is smarter than a black one, consider this: The most important job in the world is president of the United States. Over the last seven years, the most important judgment relevant to that job was whether to authorize, endorse, or oppose the use of force in Iraq. Among the dozen viable candidates who have applied for the job, one is black. Guess which one got it right?

2. Subgroup IQ can't be predicted from race. Go back and look at the German study I mentioned yesterday. Kids fathered by black soldiers scored the same as kids fathered by white soldiers. The explanation offered by hereditarians was that blacks in the military were screened for IQ, thereby wiping out the racial IQ gap.

Think about that explanation. It undermines the claim, attributed to James Watson by the Times of London, that "people who have to deal with black employees" find equality untrue. (The Times purports to have Watson's interview on tape but hasn't published the whole quote or responded to requests for it.) If employment screens out lower IQs, you can't infer squat about black employees. And that isn't the only confounding factor. Every time a study highlights some group of blacks who score well, hereditarians argue that the sample isn't random. That may be true, but it's also true of the people you live next to, work with, and meet on the street. Every black person in your office could have an IQ over 120.

3. Whitey does not come out on top. If you came here looking for material for your Aryan supremacy Web site, sorry. Stratifying the world by racial IQ will leave your folk in the dust. You might want to think about marrying a nice Jewish girl from Hong Kong. Or maybe reconsider that whole stratification idea.



William Wilberforce

On Friday July 26th 1833 as he lay on his deathbed Wilberforce exclaimed: "Thank God that I have lived to witness the day in which England is willing to give £20 million for the abolishment of slavery." (What would that be worth today ?) He died three days later.

The Slavery Abolition Bill 1833 passed through the House of Lords, it received the Royal Assent (which means it became law) on 29 August 1833 and came into force on 1 August 1834. On that date slavery was abolished throughout the vast British Empire. The Act automatically applied as new possessions (principally in Africa) subsequently became part of the British Empire.

To know who rules over you. Simply find out who it is that you are not allowed to criticise.Voltaire

We, as White people, have been GAGGED!! Then bullied, insulted, demonised, and provoked, until we object and complain. We then get called *dirty names* like Nazi, Racist, White Extremist, etc, etc.

Our weak & corrupt Lib/Lab/Con Politicians are the problem. As of Jan 2021, the UK elections are years away. Check out Populism, and Nationalism ASAP. Become "WHITE WOKE" & Push Back.

Do it today, NOW!

4. Racism is elitism minus information. No matter how crude race is as a proxy for intelligence, some people will use it that way, simply because they can see your skin but not your brain. What if we cut out the middleman? What if, instead of keeping individual IQs secret, we made them more transparent? If you don't accept IQ, pick some other measure of intelligence. You may hate labeling or "tracking" kids by test scores, but it's better than covering up what's inside their heads and leaving them to be judged, ignorantly, by what's on the surface.

5. Intermarriage is closing the gap. To the extent that IQ differences are genetic, the surest way to eliminate them is to reunite the human genome. This is already happening, including in my own family. In 1970, 1 percent of U.S. marriages were between blacks and nonblacks. By 1990, it was 4.5 percent. It may be the best punch line of the IQ debate: The more genetic the racial gap is, the faster we can obliterate it.

6. Environment matters. Genetic and environmental theories aren't mutually exclusive. Hereditarians admit that by their own reading of the data, nongenetic factors account for 20 percent to 50 percent of IQ variation. They think malnutrition, disease, and educational deprivation account for a big portion of the 30-point IQ gap between whites and black Africans. They think alleviation of these factors in the United States has helped us halve the deficit. Transracial adoption studies validate this. Korean adoption studies suggest a malnutrition effect of perhaps 10 IQ points. And everyone agrees that the black-white IQ gap closed significantly during the 20th century, which can't have been due to genes.

7. IQ is like wealth. Many people who used to condemn differences in wealth have learned to accept them. Instead of demanding parity, they focus on elevating everyone to an acceptable standard of living. Why not treat IQ the same way? This seems particularly reasonable if we accept IQ in the role for which science has certified it: not as a measure of human worth, but as a predictor of modern social and economic success.

As it turns out, raising the lowest IQs is a lot easier than equalizing higher IQs, because you can do it through nutrition, medicine, and basic schooling. As these factors improve, IQs have risen. If racial differences persist, is that really so awful? Conversely, if we can raise the lowest IQs, isn't that enough to justify the effort? One of the strangest passages in IQ scholarship is a recent attempt by hereditarians to minimize their own mediated-learning study because, while it "did raise the IQ of the African students from 83 to 97, this is still low for students at a leading university." You've got to be kidding. Screw the other universities. Going from 83 to 97 is a screaming success.

8. Life is more than g. Every time black scores improve on a test, hereditarians complain that the improvement is on "subject-specific knowledge," not on g (general intelligence). But the more you read about progress in things other than g, the more you wonder: Does g expose the limits of the progress? Or does the progress expose the limits of g?

If the progress were on g, the test-takers' lives would be easier, since g helps you apply what you've learned to new contexts. But that doesn't make other kinds of progress meaningless. People with low IQs can learn subject by subject. And they may have compensating advantages. One of my favorite disputes in the IQ literature is about test scores in Africa. Environmentalists argued that African kids

lacked motivation. Hereditarians replied that according to their own observations, African kids stayed longer to check their answers than white kids did. Diligence, too, is a transferable asset.

9. Children are more than an investment. All the evidence on race and IQ says black kids do better at younger ages, particularly with help from intervention programs. Later, the benefits fade. Hereditarians say this is genetics taking over, as happens with IQ generally. Suppose that's true. We don't abandon kids who are statistically likely to get fatal genetic diseases in their teens or 20s. Why write off kids whose IQ gains may not last? The economics may not pay off, but what about human rights?

10. Genes can be changed. Hereditarians point to phenylketonuria as an example of a genetic but treatable cognitive defect. Change the baby's diet, and you protect its brain. They also tout breast-feeding as an environmental intervention. White women are three times more likely than black women to breast-feed their babies, they observe, so if more black women did it, IQs might go up. But now it turns out that breast-feeding, too, is a genetically regulated factor. As my colleague Emily Bazelon explains, a new study shows that while most babies gain an average of seven IQ points from breast-feeding, some babies gain nothing from it and end up at a four-point disadvantage because they lack a crucial gene.

The study's authors claim it "shows that genes may work via the environment to shape the IQ, helping to close the nature versus nurture debate." That's true if you have the gene. But if you don't, nurture can't help you. And guess what? According to the International Hapmap Project, 2.2 percent of the project's Chinese-Japanese population samples, 5 percent of its European-American samples, and 10 percent of its Nigerian samples lack the gene. The Africans are twice as likely as the Americans, and four times as likely as the Asians, to start life with a four-point IQ deficit out of sheer genetic misfortune.

Don't tell me those Nigerian babies aren't cognitively disadvantaged. Don't tell me it isn't genetic. Don't tell me it's God's will. And in the age of genetic modification, don't tell me we can't do anything about it.

No, we are not created equal. But we are endowed by our Creator with the ideal of equality, and the intelligence to finish the job.

William Saletan is Slate's national correspondent and author of *Bearing Right: How Conservatives Won the Abortion War*.

Copyright 2007 Washingtonpost.Newsweek Interactive Co. LLC

<http://www.slate.com/id/2178122/>

Comment

Kieth Norman - Canada

11-29-7

Intelligence Quotient (for us dumbbells refers to "I.Q") is the measure of someone's 'intelligence' as prognosticated by a supposedly scientific statistical

administrative body intelligence test; and relates the quantitative relationship of a person's mental age to that person's chronological age(actual)..and then it is multiplied by 100.

Why multiply by 100 one may ask? Else we all will appear rather dumb, inarticulate and stupid and get allied with the lower life maggots, snakes and monkeys. Which illustrates the point that not all people should be afforded this enhancement. Is Bush,Blair,Olmert and Cheney listening

Question: Did any of these brilliant genetic 'progressive' biologists/scientists ever think of checking to determine whether or not God had filed a patent claim on his work in DNA and genetic research. Was their God better than our God, for that may be the difference. :-)

Evangelical Genetic Biologists will now take up this challenge, possibly.

Among Research Scientists and the biologist who specializes in genetics, there are many differences in their approach and evaluation technique which if leading to an agreed fact or principle is a good thing.

One of these "good things"(agreements) shows how Short Term Memory (STM-sensory memory) eventually morphs into long term (LTM) but is subject to a number of factors. Primarily, repetition of theme , and over-learnedness

Possibly, we may experience the delight of achieving a straight 'A+' passing with the additional knowledge that you have reduced your number of neuron hubs and connections by a proportional amount. Not unlike the old computer memory banks

Making the assumption that bigger brains carries and delivers more information at any given moment in time can be interrogated when one equates the yesterdays large (comparative) type discrete capacitor, transistor, resistor and inductor electronic circuits to contemporary small scale micro integrated circuits...and nanotech 'motor-circuits'.

The important parameter which is also the enigma of Design Engineers is storage and retrieval times and "total distance to push this information."

Smaller does mean faster information for a given circuit. All values being equal for both big and small components, the speed will be slower with the "bigger brain", ignoring heat and inductive energy affects.

With the larger head, the motoneuronic electrical impulse to the nerve need to travel faster as they have to journey further in a larger head.

There are 'apparently' 100 billion nerve cells in the human brain Each cell is connected to some 10,000 others. Connection and electrical signals in your brain are over/around 1000 trillion..(figures will vary of course, depending on the necessary academic and political agendas)

The method of accurately enumerating or estimating the number of connections and signals is the greatest suspect in this articles genetic illustration. It is ONLY when accuracy is guaranteed that one can evaluate the bigger head with a bigger 'effective brain that MAY have more connections than its smaller counterpart.

Currently the articles writer has assumed by default that this is a physiological process. How sad,when one finds that even the famed Ivan Petrovich Pavlov was

convinced that everybody was agenda guessing...and preferred to observe the conditioned salivary responses in dogs.

Could it be that the articles paranoiac assertiveness specifically toward the "American Jew" indicates that ALL OTHER Jewish peoples in all other countries of the world are comparative imbeciles, as we whites, blacks and Asians seem to be. Tell that to the Brit Foreign Minister and then sit back and just await some kosher words of farm animal wisdom.

The brain is made of 60% fat...lard...blubber, whatever (intellectual sources do vary on percentage here). Fat serves as a source of energy. It also cushions and insulates/isolates vital organs.

Ann-Charlotte Granholm of the Medical University of South Carolina in Charleston.

"presented the results of the study, which showed that trans-fats adversely affected rats' learning ability, at the Society for Neuroscience meeting in San Diego, US, on Monday." New Scientist

To keep the fat of the Bigger Brain in 'prime' condition, one would imagine that it is necessary to eat Kosher food repeatedly or when the Rabbi reiterates the benefits of the eating habit.

That be the case, are the American Rabbis genetically and intellectually superior to European and Israeli Rabbis??

Remember the Geneticists findings on "repetition" and "learnedness."

So, this is the rationale for New York getting rid of its trans fats. Are they falling to the level of just a "White American" or God forbid, to the lunacy of a white Brit without his Oxford Dic.

Professional Researchers and Practitioners ALL AGREE (100%) that the understanding of the human brain is extremely limited and for that we should ask ourselves the explanation for the articles writers purpose, agenda and order of business that seemingly stirs the cauldron of hatred and malice. Does he gain anything from putting out such infantile theories of human kind.

I ask the writer to ascertain the location of his aggressive behavioral stance on Genetic Superiority. It is kept in the "Amygdala" and located on the inner fold of the temporal lobe.

When the time comes to write yet another hateful and insulting sentence and paragraph, the writer whomever, should scratch behind his ear vigorously and wait a few minutes.

For all young Black kids who are beginning to believe the intent of the article ..GO HERE

<http://www.sciencemaster.com/wesson/keynote.php>

and

http://www.eurekalert.org/pub_releases/2007-10/asu-rfe101207.php

Kieth Norman (WelshBrit)

Canada



William Wilberforce

On Friday July 26th 1833 as he lay on his deathbed Wilberforce exclaimed: "Thank God that I have lived to witness the day in which England is willing to give £20 million for the abolishment of slavery." (What would that be worth today ?) He died three days later.

The Slavery Abolition Bill 1833 passed through the House of Lords, it received the Royal Assent (which means it became law) on 29 August 1833 and came into force on 1 August 1834. On that date slavery was abolished throughout the vast British Empire. The Act automatically applied as new possessions (principally in Africa) subsequently became part of the British Empire.

To know who rules over you. Simply find out who it is that you are not allowed to criticise.Voltaire

We, as White people, have been GAGGED!! Then bullied, insulted, demonised, and provoked, until we object and complain. We then get called *dirty names* like Nazi, Racist, White Extremist, etc, etc.

Our weak & corrupt Lib/Lab/Con Politicians are the problem. As of Jan 2021, the UK elections are years away. Check out Populism, and Nationalism ASAP. Become "WHITE WOKE" & Push Back.

Do it today, NOW!

What Is Racism ? - Jared Taylor

The ' RACIST ' double standard:

From <https://www.amren.com>

How Whites are made to feel guilty and "hateful" for loving their own people and culture.

Jared Taylor, who wrote this article under the pseudonym Thomas Jackson, is also the author of the book "Paved With Good Intentions: The Failure Of Race Relations In America"

There is surely no nation in the world that holds "racism" in greater horror than does the United States. Compared to other kinds of offenses, it is thought to be somehow more reprehensible. The press and public have become so used to tales of murder, rape, robbery, and arson, that any but the most spectacular crimes are shrugged off as part of the inevitable texture of American life. "Racism" is never shrugged off. For example, when a White Georgetown Law School student reported earlier this year that black students are not as qualified as White students, it set off a booming, national controversy about "racism." If the student had merely murdered someone he would have attracted far less attention and criticism.

Racism is, indeed, the national obsession. Universities are on full alert for it, newspapers and politicians denounce it, churches preach against it, America is said to be racked with it, but just what is racism?

Dictionaries are not much help in understanding what is meant by the word. They usually define it as the belief that one's own ethnic stock is superior to others, or as the belief that culture and behavior are rooted in race. When Americans speak of racism they mean a great deal more than this. Nevertheless, the dictionary definition of racism is a clue to understanding what Americans do mean. A peculiarly American meaning derives from the current dogma that all ethnic stocks are equal. Despite clear evidence to the contrary, all races have been declared to be equally talented and hard- working, and anyone who questions the dogma is thought to be not merely wrong but evil.

The dogma has logical consequences that are profoundly important. If blacks, for example, are equal to Whites in every way, what accounts for their poverty, criminality, and dissipation? Since any theory of racial differences has been outlawed, the only possible explanation for black failure is White racism. And since blacks are markedly poor, crime-prone, and dissipated, America must be racked

with pervasive racism. Nothing else could be keeping them in such an abject state.

All public discourse on race today is locked into this rigid logic. Any explanation for black failure that does not depend on White wickedness threatens to veer off into the forbidden territory of racial differences. Thus, even if today's Whites can find in their hearts no desire to oppress blacks, yesterday's Whites must have oppressed them. If Whites do not consciously oppress blacks, they must oppress them Unconsciously. If no obviously racist individuals can be identified, then societal institutions must be racist. Or, since blacks are failing so terribly in America, there simply must be millions of White people we do not know about, who are working day and night to keep blacks in misery. The dogma of racial equality leaves no room for an explanation of black failure that is not, in some fashion, an indictment of White people.

The logical consequences of this are clear.

Since we are required to believe that the only explanation for non-White failure is White racism, every time a non-White is poor, commits a crime, goes on welfare, or takes drugs, White society stands accused of yet another act of racism. All failure or misbehavior by non-Whites is standing proof that White society is riddled with hatred and bigotry. For precisely so long as non-Whites fail to succeed in life at exactly the same level as Whites, Whites will be, by definition, thwarting and oppressing them. This obligatory pattern of thinking leads to strange conclusions. First of all, racism is a sin that is thought to be committed almost exclusively by White people. Indeed, a black congressman from Chicago, Gus Savage, and Coleman Young, the black mayor of Detroit, have argued that only White people can be racist. Likewise, in 1987, the affirmative action officer of the State Insurance Fund of New York issued a company pamphlet in which she explained that all Whites are racist and that only Whites can be racist. How else could the plight of blacks be explained without flirting with the possibility of racial inequality?

Although some blacks and liberal Whites concede that non-Whites can, perhaps, be racist, they invariably add that non-Whites have been forced into it as self-defense because of centuries of White oppression. What appears to be non-White racism is so understandable and forgivable that it hardly deserves the name. Thus, whether or not an act is called racism depends on the race of the racist. What would surely be called racism when done by Whites is thought to be normal when done by anyone else. The reverse is also true.

Examples of this sort of double standard are so common, it is almost tedious to list them: When a White man kills a black man and uses the word "nigger" while doing so, there is an enormous media uproar and the nation beats its collective breast; when members of the black Yahweh cult carry out ritual murders of random Whites, the media are silent (see AR of March, 1991). College campuses forbid



William Wilberforce

On Friday July 26th 1833 as he lay on his deathbed Wilberforce exclaimed: "Thank God that I have lived to witness the day in which England is willing to give £20 million for the abolishment of slavery." (What would that be worth today ?)

He died three days later.

The Slavery Abolition Bill 1833 passed through the House of Lords, it received the Royal Assent (which means it became law) on 29 August 1833 and came into force on 1 August 1834. On that date slavery was abolished throughout the vast British Empire.

The Act automatically applied as new possessions (principally in Africa) subsequently became part of the British Empire.

To know who rules over you. Simply find out who it is that you are not allowed to criticise.Voltaire

We, as White people, have been GAGGED!! Then bullied, insulted, demonised, and provoked, until we object and complain. We then get called *dirty names* like Nazi, Racist, White Extremist, etc, etc.

Our weak & corrupt Lib/Lab/Con Politicians are the problem. As of Jan 2021, the UK elections are years away. Check out Populism, and Nationalism ASAP. Become "WHITE WOKE" & Push Back.

Do it today, NOW!

pejorative statements about non-Whites as "racist," but ignore scurrilous attacks on Whites.

At election time, if 60 percent of the White voters vote for a White candidate, and 95 percent of the black voters vote for the black opponent, it is Whites who are accused of racial bias. There are 107 "historically black" colleges, whose fundamental blackness must be preserved in the name of diversity, but all historically White colleges must be forcibly integrated in the name of... the same thing. To resist would be racist.

"Black pride" is said to be a wonderful and worthy thing, but anything that could be construed as an expression of White pride is a form of hatred. It is perfectly natural for third-world immigrants to expect school instruction and driver's tests in their own languages, whereas for native Americans to ask them to learn English is racist.

Blatant anti-White prejudice, in the form of affirmative action, is now the law of the land. Anything remotely like affirmative action, if practiced in favor of Whites, would be attacked as despicable favoritism.

All across the country, black, Hispanic, and Asian clubs and caucuses are thought to be fine expressions of ethnic solidarity, but any club or association expressly for Whites is by definition racist. The National Association for the Advancement of Colored People (NAACP) campaigns openly for black advantage but is a respected "civil rights" organization. The National Association for the Advancement of White People (NAAWP) campaigns merely for equal treatment of all races, but is said to be viciously racist.

At a few college campuses, students opposed to affirmative action have set up student unions for Whites, analogous to those for blacks, Hispanics, etc, and have been roundly condemned as racists. Recently, when the White students at Lowell High School in San Francisco found themselves to be a minority, they asked for a racially exclusive club like the ones that non-Whites have. They were turned down in horror. Indeed, in America today, any club not specifically formed to be a White enclave but whose members simply happen all to be White is branded as racist.

Today, one of the favorite slogans that define the asymmetric quality of American racism is "celebration of diversity." It has begun to dawn on a few people that "diversity" is always achieved at the expense of Whites (and sometimes men), and never the other way around. No one proposes that Howard University be made more diverse by admitting Whites, Hispanics, or Asians. No one ever suggests that National Hispanic University in San Jose (CA) would benefit from the diversity of having non-Hispanics on campus. No one suggests that the Black Congressional Caucus or the executive ranks of the NAACP or the Mexican-American Legal

Defense and Educational Fund suffer from a lack of diversity. Somehow, it is perfectly legitimate for them to celebrate homogeneity. And yet any all-White group - a company, a town, a school, a club, a neighborhood - is thought to suffer from a crippling lack of diversity that must be remedied as quickly as possible. Only when Whites have been reduced to a minority has "diversity" been achieved.

Let us put it bluntly:

To "celebrate" or "embrace" diversity, as we are so often asked to do, is no different from deploring an excess of Whites. In fact, the entire nation is thought to suffer from an excess of Whites. Our current immigration policies are structured so that approximately 90 percent of our annual 800,000 legal immigrants are non-White. The several million illegal immigrants that enter the country every year are virtually all non-White. It would be racist not to be grateful for this laudable contribution to "diversity." It is, of course, only White nations that are called upon to practice this kind of "diversity." It is almost criminal to imagine a nation of any other race countenancing blatant dispossession of this kind.

What if the United States were pouring its poorest, least educated citizens across the border into Mexico? Could anyone be fooled into thinking that Mexico was being "culturally enriched?" What if the state of Chihuahua were losing its majority population to poor Whites who demanded that schools be taught in English, who insisted on celebrating the Fourth of July, who demanded the right to vote even if they weren't citizens, who clamored for "affirmative action" in jobs and schooling?

Would Mexico - or any other non-White nation - tolerate this kind of cultural and demographic depredation? Of course not. Yet White Americans are supposed to look upon the flood of Hispanics and Asians entering their country as a priceless cultural gift. They are supposed to "celebrate" their own loss of influence, their own dwindling numbers, their own dispossession, for to do otherwise would be hopelessly racist.

There is another curious asymmetry about American racism. When non-Whites advance their own racial purposes, no one ever accuses them of "hating" another group. Blacks can join "civil rights" groups and Hispanics can be activists without fear of being branded as bigots and hate mongers. They can agitate openly for racial preferences that can come only at the expense of whites. They can demand preferential treatment of all kinds without anyone ever suggesting that they are "anti-white."

Whites, on the other hand, need only express their opposition to affirmative action to be called haters. They need only subject racial policies that are clearly prejudicial to themselves to be called racists. Should they actually go so far as to say that they prefer the company of their own kind, that they wish to be left alone



William Wilberforce

On Friday July 26th 1833 as he lay on his deathbed Wilberforce exclaimed: "Thank God that I have lived to witness the day in which England is willing to give £20 million for the abolishment of slavery." (What would that be worth today ?) He died three days later.

The Slavery Abolition Bill 1833 passed through the House of Lords, it received the Royal Assent (which means it became law) on 29 August 1833 and came into force on 1 August 1834. On that date slavery was abolished throughout the vast British Empire. The Act automatically applied as new possessions (principally in Africa) subsequently became part of the British Empire.

To know who rules over you. Simply find out who it is that you are not allowed to criticise.Voltaire

We, as White people, have been GAGGED!! Then bullied, insulted, demonised, and provoked, until we object and complain. We then get called *dirty names* like Nazi, Racist, White Extremist, etc, etc.

Our weak & corrupt Lib/Lab/Con Politicians are the problem. As of Jan 2021, the UK elections are years away. Check out Populism, and Nationalism ASAP. Become "WHITE WOKE" & Push Back.

Do it today, NOW!

to enjoy the fruits of their European heritage, they are irredeemably wicked and hateful.

Here then, is the final, baffling inconsistency about American race relations.

All non-whites are allowed to prefer the company of their own kind, to think of themselves as groups with interests distinct from those of the whole, and to work openly for group advantage. None of this is thought to be racist.

At the same time, whites must also champion the racial interests of non-whites.

They must sacrifice their own future on the altar of "diversity" and cooperate in their own dispossession. They are to encourage, even to subsidize, the displacement of a European people and culture by alien peoples and cultures.

To put it in the simplest possible terms,

White people are cheerfully to slaughter their own society, to commit racial and cultural suicide.

To refuse to do so, would be racism.

Of course, the entire non-white enterprise in the United States is perfectly natural and healthy. Nothing could be more natural than to love one's people and to hope that it should flourish. Filipinos and El Salvadorans are doubtless astonished to discover that simply by setting foot in the United States they are entitled to affirmative action preferences over native-born whites, but can they be blamed for accepting them? Is it surprising that they should want their languages, their cultures, their brothers and sisters to take possession and put their mark indelibly on the land? If the once-great people of a once-great nation is bent upon self-destruction and is prepared to hand over land and power to whomever shows up and asks for it, why should Mexicans and Cambodians complain?

No, it is the White enterprise in the United States that is unnatural, unhealthy, and without historical precedent. Whites have let themselves be convinced that it is racist merely to object to dispossession, much less to work for their own interests. Never in the history of the world has a dominant people thrown open the gates to strangers, and poured out its wealth to aliens. Never before has a people been fooled into thinking that there was virtue or nobility in surrendering its heritage, and giving away to others its place in history. Of all the races in America, only whites have been tricked into thinking that a preference for one's own kind is racism. Only whites are ever told that a love for their own people is somehow

"hatred" of others. All healthy people prefer the company of their own kind, and it has nothing to do with hatred. All men love their families more than their neighbors, but this does not mean that they hate their neighbors. Whites who love their racial family need bear no ill will towards non-whites. They only wish to be left alone to participate in the unfolding of their racial and cultural destinies.

What whites in America are being asked to do is therefore utterly unnatural. They are being asked to devote themselves to the interests of other races and to ignore the interests of their own. This is like asking a man to forsake his own children and love the children of his neighbors, since to do otherwise would be "racist."

What then, is "racism?"

It is considerably more than any dictionary is likely to say. It is any opposition by whites to official policies of racial preference for non-whites. It is any preference by whites for their own people and culture. It is any resistance by whites to the idea of becoming a minority people. It is any unwillingness to be pushed aside. **It is, in short, any of the normal aspirations of people-hood that have defined nations since the beginning of history - but only so long as the aspirations are those of whites.**

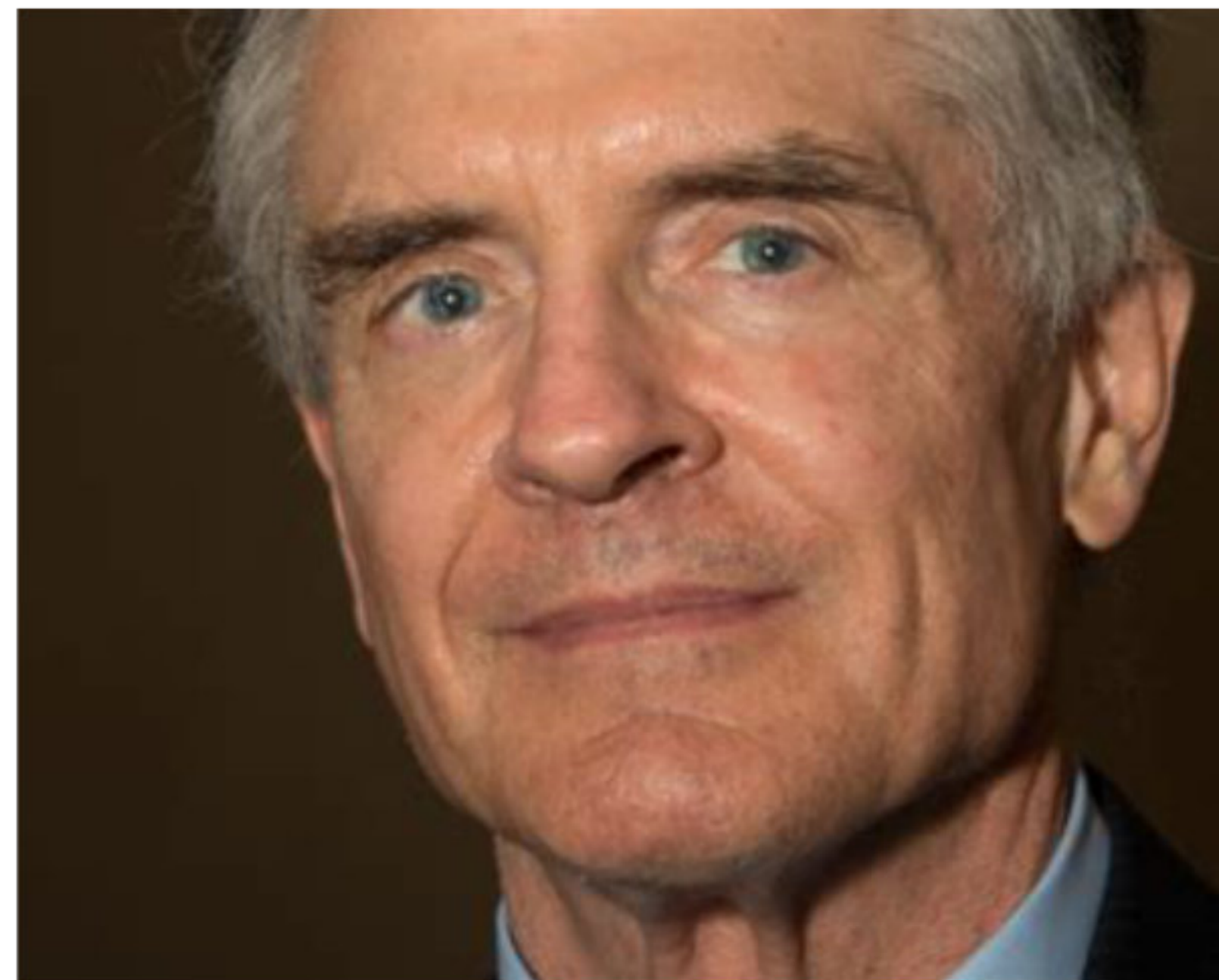

Jared Taylor



William Wilberforce

On Friday July 26th 1833 as he lay on his deathbed Wilberforce exclaimed: "Thank God that I have lived to witness the day in which England is willing to give £20 million for the abolishment of slavery." (What would that be worth today ?) He died three days later.

The Slavery Abolition Bill 1833 passed through the House of Lords, it received the Royal Assent (which means it became law) on 29 August 1833 and came into force on 1 August 1834. On that date slavery was abolished throughout the vast British Empire. The Act automatically applied as new possessions (principally in Africa) subsequently became part of the British Empire.

To know who rules over you. Simply find out who it is that you are not allowed to criticise.Voltaire

We, as White people, have been GAGGED!! Then bullied, insulted, demonised, and provoked, until we object and complain. We then get called *dirty names* like Nazi, Racist, White Extremist, etc, etc.

Our weak & corrupt Lib/Lab/Con Politicians are the problem. As of Jan 2021, the UK elections are years away. Check out Populism, and Nationalism ASAP. Become "WHITE WOKE" & Push Back.

Do it today, NOW!

John Woods Dissects an unsatisfactory Home Office study of race and crime.

I acquired recently a copy of a 1999 Home Office publication entitled Statistics on Race and the Criminal Justice System: A Home Office publication under Section 95 of the Criminal Justice Act 1991*.

The 1999 edition is the fifth in a series, with previous reports issued in 1992, 1994, 1995 and 1997. This remarkable study makes for a most interesting read.

First, you have to wade through the statutory foreword by Jack Straw telling us that we must learn the lessons of the Macpherson report, and purge the criminal justice system of "institutional racism". Then we have another foreword by Mr Justice Rose, Chairman of the Criminal Justice Consultative Committee, stating that we must learn the lessons of the Macpherson Report and purge the criminal justice system of "institutional racism". Then we have an insert from the Commission for Racial Equality telling us that we must learn the lessons of the Macpherson Report and purge the criminal justice system of "institutional racism".

Then we have a discussion on deaths of black people in police custody. Then we are told that blacks are six times more likely to be stopped and searched by police. Then we are told that racist incidents are up by 66% over the last year, "although this is thought to be due to better reporting". Then we have the usual breast-beating about how there are not enough black policemen, prison officers, magistrates or judges. Then we are told that 9% of homicide victims in the UK in the period covered by the survey (1996-99) were black, an over-representation by a factor of four and a half (although we are not told who committed these murders.)

And then - finally - buried half way down Table 7.5 on page 44, we get some real figures.

'Res ipsa loquitor', as they doubtless say in Brixton police station canteen. Bear in mind that 2% of the population of the UK is classified as black. The figures are stark: as of 30th June 1998, 7.1% of those serving prison sentences for burglary were black. The equivalent figure for theft and handling is 7.5%, for sexual offences 8.1%, violence against the person 9.7%, fraud and forgery 13.2% and drugs offences 19%, while for robbery it is a staggering 22.6%. Now, the massive over-representation of blacks in these categories, could, I am sure, be 'explained' by reference to "institutional racism". There will no doubt be many who hold that these are the only career options open to black youths. But I defy even Lord Macpherson to explain, for example, a four-fold over-representation in sex crimes among blacks by reference to that meaningless concept. Perhaps wisely, the Home Office does not give us a breakdown of the racial origins of the victims of black sexual crime.

I would also be interested in seeing the figures for juveniles convicted of sexual offences.

Moreover, virtually every Asian ethnic group within the UK is under-represented in the jails - except in fraud cases. The incarceration rate for Indians is one fourteenth of the black rate. Yet, presumably, Asians must be labouring under the same yoke of societal "institutional racism" as blacks? Furthermore, if we are to explain the six-fold over-representation of blacks in prison by reference to that elastic concept, and we note the fact that whites are over-represented in prison in comparison with Asians, then the logical conclusion would seem to be that the criminal justice system must be "institutionally racist" against whites.

But that would be an absurd conclusion.

Blacks represent 2% of the population of the UK, 12% of the jail population and 15% of incarcerated young offenders. Even this, however, does not tell the full story, as the figures do not distinguish between Africans and Afro-Caribbeans. It may be an hypothesis too far, but I would be prepared to wager that the following propositions are true: that the proportion of blacks of African origin incarcerated, although significantly larger than the percentage of whites or Asians, will be significantly smaller than the proportion of Afro-Caribbeans. Therefore the over-representation among Afro-Caribbeans will be even more extraordinary than these figures would suggest. I suspect also that the sociological profile of the type of crime for which Africans are imprisoned will be rather different than that for Afro-Caribbeans. Astoundingly, blacks are over-represented by a factor of six or seven among those incarcerated for fraud and forgery. I suspect that the majority of these will be West Africans rather than West Indians.

Massaging the figures

But the real story here is the way that the Home Office has presented the figures. The statistics would appear to have been set out in a deliberately misleading, confusing and obfuscatory manner, designed to prevent the casual reader from working out the true situation. One has to wade through reams of information on arrest rates in the various county police forces, where very few members of ethnic minorities reside, and the figures for the Met., the West Midlands etc, are buried among them. It is not terribly meaningful to tell us that 99% of those arrested by Dyfed-Powys or Devon & Cornwall Police are white. Moreover, the percentages of arrests for the various different ethnic groups within a particular police area are not compared with the actual ethnic breakdown of the population within that area, except for the Metropolitan Police District and a few others. And these are presented several pages apart, perhaps in the hope that no-one will notice them.

The picture in London

According to the Home Office figures, 7.5 % of the population of London are black. A quarter of all the arrests in the Metropolitan Police District are of black people. As relatively few blacks live in suburban areas of London, I would suggest that they must now represent a majority, or close to it, in arrests in almost every category of crime in the inner London boroughs. Blacks represent 54% of those arrested for robbery in London. In the inner city, this must surely be 80-90%. Again, the race of the victims of these robberies is not recorded. I wonder why not.

Another jaw-dropping statistic: during the period 1996-1999 which this survey covers, 59 black people and 69 white people died from gunshot wounds. The



William Wilberforce

On Friday July 26th 1833 as he lay on his deathbed Wilberforce exclaimed: "Thank God that I have lived to witness the day in which England is willing to give £20 million for the abolishment of slavery." (What would that be worth today ?) He died three days later.

The Slavery Abolition Bill 1833 passed through the House of Lords, it received the Royal Assent (which means it became law) on 29 August 1833 and came into force on 1 August 1834. On that date slavery was abolished throughout the vast British Empire. The Act automatically applied as new possessions (principally in Africa) subsequently became part of the British Empire.

To know who rules over you. Simply find out who it is that you are not allowed to criticise.Voltaire

We, as White people, have been GAGGED!! Then bullied, insulted, demonised, and provoked, until we object and complain. We then get called *dirty names* like Nazi, Racist, White Extremist, etc, etc.

Our weak & corrupt Lib/Lab/Con Politicians are the problem. As of Jan 2021, the UK elections are years away. Check out Populism, and Nationalism ASAP. Become "WHITE WOKE" & Push Back.

Do it today, NOW!

chances of a black person being shot dead are therefore approximately 40 times higher than for a white person. In virtually every case, blacks who died of gunshot wounds were shot by other blacks.

"Racially motivated incidents"

On page 47 of this extraordinary document, one finds another startling statistic relating to "racially motivated incidents". The British Crime Survey, published in 1998, estimates that in 1995, 382,000 offences were racially motivated. Of these, 143,000 were committed against members of ethnic minorities, and 238,000 against white people. This fact is extraordinary enough in itself. More extraordinary still is the lack of further discussion given to it in this report. And of course, the Home Office is not indelicate enough to point out the obvious corollary: if the ethnic minorities comprise 6% of the population of the UK, and are producing 238,000 racial assaults per year, and the white population, who comprise 94% of the population, are producing 143,000 racial assaults per year, it would appear that, on a per capita basis, the ethnic minorities are producing about 25 times more racial assaults than the white population.

In fact, this clearly underestimates the discrepancy, since some of the racial assaults against blacks will have been committed by Asians, and some (I would guess a lot) of the assaults on Asians will have been committed by blacks (like the murderous attack on Abdul Bhatti at Notting Hill). Moreover, the British Crime Survey does not tell us who committed the 238,000 racial assaults against whites. I think we may safely assume that the majority were not committed by Sikhs, Parsees, Thais or Hong Kong Chinese.

Obviously, certain caveats must be borne in mind. What constitutes a racial assault? If two motorists of different pigmentations get into an altercation over a parking space, does this constitute a racial incident? If one of them employs racial epithets in the course of the dispute, does it then become one? Fortunately, we now know what constitutes a racial assault, because Macpherson's definition has been accepted by the Government, the police and the Crown Prosecution Service, and is reproduced in this document. "A racial incident is any incident which is perceived to be racist by the victim or any other person".

So, if 238,000 white people per year perceive themselves to have been the victims of racist crimes, then they must have been, mustn't they?

Missing the point

On page 15 of the Home Office document, we are told "Much (sic) of these differences were found to be due to socio-demographic factors that are associated with victimisation. For example, ethnic minorities tend, on average, to be younger, of lower socio-economic status, and more often living in higher risk areas". This is an exercise in deliberately missing the point. Certain ethnic minorities - Indians and Chinese, for example - have an average social status which is significantly higher than that of whites, and a crime rate which is approximately half the national average. It is only blacks who are of a significantly lower average social status. And, of course, the Home Office statisticians do not address themselves to the question of why this should be. **Blacks certainly do live in higher risk areas. They are higher risk areas for a very good reason.**

But then the whole document is an exercise in deliberately missing the point. Almost every civil servant, policeman, judge, prosecutor and journalist is busily missing the point these days, busily pretending that the emperor has got some clothes on, because in Tony's Britain, that's how you keep your job.

The reality of the situation is simply too horrific for liberals to contemplate. Therefore, they choose not to contemplate it, preferring to scapegoat the police, or the judiciary, or the schools, or anyone or anything else, rather than face the facts. Unfortunately, however much we might all wish it, reality will not go away.

John Woods writes from Hertfordshire

* Copies of Statistics on Race and the Criminal Justice System can be obtained by writing to:

Information & Publications Group,
Room 201, 50 Queen Anne's Gate, London, SW1H 9AT.

Telephone: 020 7273 2084 Fax: 020 7222 0211

E-mail: rds.ho@gtnet.gov.uk

The report can also be obtained from the following web address:

www.homeoffice.gov.uk/rds/index.htm

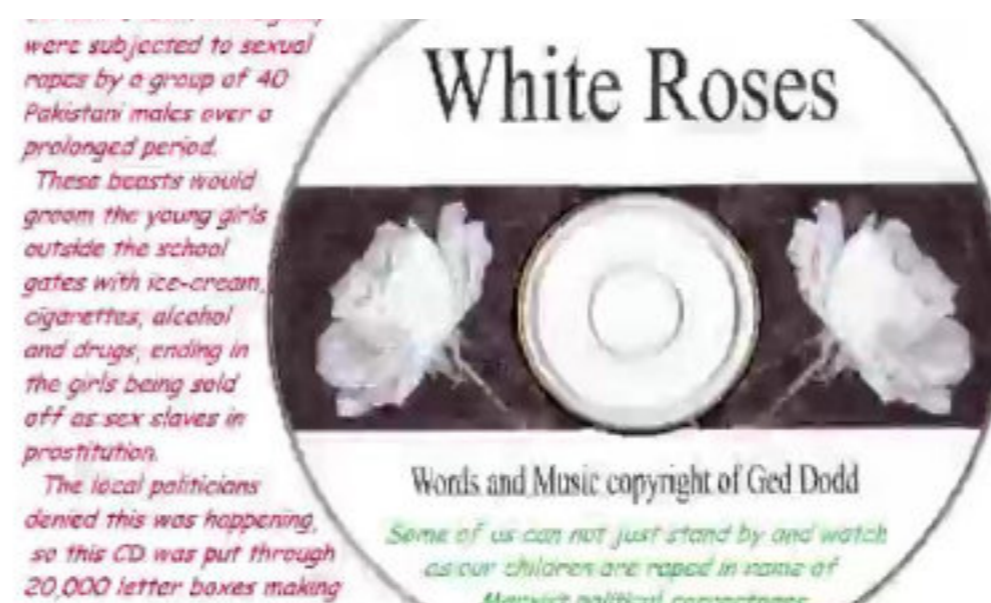

In 2004/5 the local girls in the Yorkshire town of Keighley were subjected to sexual rapes by a group of about 40 Pakistani males over a prolonged period. **The local politicians denied this was happening**

Open

We stabbed your White boy !!

15 Minute video.

Just some of the White victims that you hardly, or never, heard of.

Open

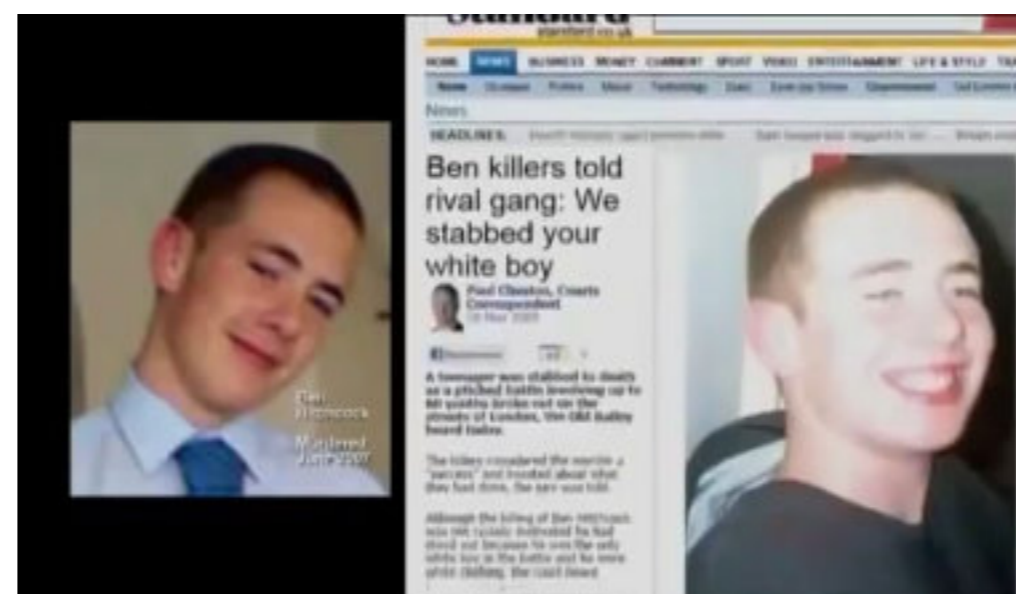

This article was originally published by Mr Derek Turner on his news website, that sadly is no longer with us.

Books by Derek Turner on Amazon

https://www.amazon.com/Derek-Turner/e/B01GYLQUP2?ref_=pe_1724030_132998060

Mr Turners personal site can be found here

<https://www.derek-turner.com/>



William Wilberforce

On Friday July 26th 1833 as he lay on his deathbed Wilberforce exclaimed: "Thank God that I have lived to witness the day in which England is willing to give £20 million for the abolishment of slavery." (What would that be worth today ?) He died three days later.

The Slavery Abolition Bill 1833 passed through the House of Lords, it received the Royal Assent (which means it became law) on 29 August 1833 and came into force on 1 August 1834. On that date slavery was abolished throughout the vast British Empire. The Act automatically applied as new possessions (principally in Africa) subsequently became part of the British Empire.

To know who rules over you. Simply find out who it is that you are not allowed to criticise.Voltaire

We, as White people, have been GAGGED!! Then bullied, insulted, demonised, and provoked, until we object and complain. We then get called dirty names like Nazi, Racist, White Extremist, etc, etc.

Our weak & corrupt Lib/Lab/Con Politicians are the problem. As of Jan 2021, the UK elections are years away. Check out Populism, and Nationalism ASAP. Become "WHITE WOKE" & Push Back.

Do it today, NOW!

The Left And The Corruption Of Language And Thought

Patrick Spooner, Monday 26 January 2004

I have mentioned before the instantaneous reversal of parity by the left and their docile, obedient followers (journalists and "educationists" mainly) when the iron curtain was dropped and the Soviet Union was, at last, revealed in its full glory.

Finally the left was forced to admit that it really was what critics of socialism had been saying it had been for decades: a gigantic charnel house coffin, reeking with slave labor camps and death camps, in which the people had been kept in a state of terror, poverty, and miserable, drab, slavery for seven decades. (Of course the left knew this; but, to them, the preservation of the socialist myth was more important than the freedom and lives of 300 million people, so they stayed absolutely silent until the revelations of 1989/90).

But when their faces were, at last, rubbed in the dried blood of tens of millions of victims, they immediately began referring to those who wanted to largely abandon socialism and introduce some economic freedom as the 'left', and those who wished to retain socialism as the "right".

Martin Gardner, the American philosopher long beloved for his Mathematical Games column in Scientific American, once wrote a book called The Ambidextrous Universe about left and right, and the phenomenon of parity reversal. Perhaps he should publish a new edition, and mention this as an example: it is certainly as bizarre as anything else he mentioned in the book.

Another example of the abuse of language by the left which I think I have mentioned is the description of Pol Pot as a "capitalist", once the truth had finally been revealed to the left (everybody else knew what was happening only weeks after Pol Pot seized power; it was not leftist media darling John Pilger that revealed the truth to the world, but the Cambodian people themselves).

Millions of words of evidence of atrocities unspeakable even by Soviet or Nazi standards poured from the mouths of refugees, which the left chose to totally ignore, except to accuse these tragically affected people - most of them ordinary peasants - of being "landlords" or "gold hoarders").

To mention another case: those on the left commonly describe themselves as "progressive", implying that everybody else, especially those who believe in

individual rights, are somehow backward. However, socialism is anything but a "progressive" philosophy; rather, it is very close to the feudalist societies of medieval Europe. The reader is recommended to Barbara Tuchman's The Distant Mirror. Here she gives a description of feudal society and its human relationships. The parallels with a socialist state or a modern, centrally directed, authoritarian welfare state, are striking.

The land-owning nobility were the equivalent of the government and its bureaucrats today. The church, supposedly pure and highly moral, but in fact hypocritical, venal, and totally opposed to human liberty, have, today, been replaced by the college and university: today's academics are the exact equivalent of the priests of feudal times. The nobility and the church saw themselves as the protectors of the poorest class, the serfs.

These earthly and spiritual rulers were so morally pure that, by their own lights, their whole lives were devoted to the interests of the poor, land-bound serf. And the most reviled and despised person in feudal society was, of course, the merchant. He was the equivalent of today's capitalist, and the rulers absolutely loathed him, and were constantly introducing new laws to fetter him.

The worst thing about the merchant was that he actually had something to offer the serf besides pious words, perpetual slavery, and massive theft. He had all kinds of goods, especially cheap cloths, often imported, which the serf could afford, and which came in bright hues. This last is very important to somebody who is otherwise condemned to wearing dark, filthy rags for their whole life; and the barons and priests, sensing that the serf might actually start to think about his independence and self-respect, brought in laws forbidding the underclasses to wear any colors apart from brown and black.

The serf had to, at all times, be kept as a slave beholden to the banquet hall and the pulpit; the reviled merchant represented an open threat to this relationship. The merchant wanted the serf to be free; he would then be a better customer, but the barons "protected" the serf from such dangerous ideas as freedom and individual rights.

Socialist dictatorships this century are exactly the same; the laboring classes have no hope of betterment, while all the positions of money and power are filled by the idiot children of the ruling clique. The expository passage in 1984 describes this feature of collectivist societies very well.

The liberation of the poor, and the destruction of the system that had oppressed them for so long, occurred with the industrial revolution and free market capitalism. As Lord Acton pointed out, the social class which has the most to gain from economic freedom is the laboring poor - the rich, on the other hand, are



William Wilberforce

On Friday July 26th 1833 as he lay on his deathbed Wilberforce exclaimed: "Thank God that I have lived to witness the day in which England is willing to give £20 million for the abolishment of slavery." (What would that be worth today ?) He died three days later.

The Slavery Abolition Bill 1833 passed through the House of Lords, it received the Royal Assent (which means it became law) on 29 August 1833 and came into force on 1 August 1834. On that date slavery was abolished throughout the vast British Empire. The Act automatically applied as new possessions (principally in Africa) subsequently became part of the British Empire.

To know who rules over you. Simply find out who it is that you are not allowed to criticise.Voltaire

We, as White people, have been GAGGED!! Then bullied, insulted, demonised, and provoked, until we object and complain. We then get called *dirty names* like Nazi, Racist, White Extremist, etc, etc.

Our weak & corrupt Lib/Lab/Con Politicians are the problem. As of Jan 2021, the UK elections are years away. Check out Populism, and Nationalism ASAP. Become "WHITE WOKE" & Push Back.

Do it today, NOW!

greatly threatened by liberty and free movement between classes. So much for the slippery and evil abuse of language which sees socialism as "progressive" and freedom as "reactionary".

Possibly the worst example of language abuse in this nation is that which sees the word "liberal" as referring to anybody who believes to a large degree in authoritarian collectivism. This is an atrocious and utterly dishonest inversion which those who believe in individual rights should never have tolerated.

The word "liberal" is derived from the ancient Greek word for freedom, and in other countries refers to exactly that. The now defunct Liberal Party in Britain was the successor to the Whigs, those who stood for freedom against the rigid class structuralists of the Tory Party, and, later, the socialist enslavers of the Labor Party.

It has been said that all people can be divided into two groups: Platonists and Aristotelians. Plato was the first collectivist totalitarian; his Republic is the first socialist state. Noam Chomsky, Al Gore, the Clintons etc are unquestionably Platonists. This correspondent (and his publisher) are Aristotelians, those who put the rights of the individual ahead of the whims of Plato's philosopher kings (and queens).

This Aristotelian group are the true liberals. I call on anybody who passionately believes in genuine human rights to reclaim the word "liberal": we should never have let it go without a fight.

The reason I am writing about this at such length is that once language is corrupted, the whole process of thought is corrupted too. George Orwell made this point painfully clear in 1984. It is YOUR responsibility to never allow the left to get away with the kind of language corruption and distortion I have written of here. If you do, you will find that your children will, eventually, no longer be able, much less permitted, to think clearly and question the nostrums of the left. Corrupt language corrupts thought; please, please, never forget that.



William Wilberforce
On Friday July 26th 1833 as he lay on his deathbed Wilberforce exclaimed: "Thank God that I have lived to witness the day in which England is willing to give £20 million for the abolishment of slavery." (What would that be worth today ?)
He died three days later.

The Slavery Abolition Bill 1833 passed through the House of Lords, it received the Royal Assent (which means it became law) on 29 August 1833 and came into force on 1 August 1834. On that date slavery was abolished throughout the vast British Empire. The Act automatically applied as new possessions (principally in Africa) subsequently became part of the British Empire.

To know who rules over you. Simply find out who it is that you are not allowed to criticise.Voltaire

We, as White people, have been GAGGED!! Then bullied, insulted, demonised, and provoked, until we object and complain. We then get called *dirty names* like Nazi, Racist, White Extremist, etc, etc.

Our weak & corrupt Lib/Lab/Con Politicians are the problem. As of Jan 2021, the UK elections are years away. Check out Populism, and Nationalism ASAP. Become "WHITE WOKE" & Push Back. **Do it today, NOW!**

Works For Me - Ethnic Recruitment

talkingpoint@memediagroup.com

<http://www.Worksfm.com>

Getting Rid Of The White Race

Worksfm.com

Number one for ethnic recruitment.

(Does this mean NO WHITES PLEASE ??)

Intermediary provider for Jobcentre plus.

On Saturday the 21st of October 2006, I went to the Evening Standard - METRO Careers & Jobs Exhibition at Earls Court.

I was barely through the front door when this leaflet was given to me by a young Asian male.

It speaks volumes about how severely brainwashed we have all become, that a leaflet like this could be openly distributed at this event by a company with such close links with the Employment Services.

Sean Bryson

Dear Sean,

Just read your article re the ethnic recruitment free-sheet »—> 'Works for Me'

(Earl's Court, London, 21st October 2006)

I've been fighting to get the thing withdrawn from our local jobcentre since it first appeared. At the last elections they ran a series of letters on its correspondence page in the usual sixth form lefty vein and invited response from "those thinking of voting for the BNP". Well they got one! see below.

Worksfm.com
Number one for ethnic recruitment

020 7693 8400 to advertise
Intermediary provider for Jobcentre plus

clickwalla.com
News • Entertainment • Dating
Food & Drink • Club Listings • Health
• Fashion • Competitions and **much more!**

To advertise on clickwalla.com
Call 020 7693 8400



William Wilberforce
On Friday July 26th 1833 as he lay on his deathbed Wilberforce exclaimed: "Thank God that I have lived to witness the day in which England is willing to give £20 million for the abolishment of slavery." (What would that be worth today ?)
He died three days later.

The Slavery Abolition Bill 1833 passed through the House of Lords, it received the Royal Assent (which means it became law) on 29 August 1833 and came into force on 1 August 1834. On that date slavery was abolished throughout the vast British Empire. The Act automatically applied as new possessions (principally in Africa) subsequently became part of the British Empire.

To know who rules over you. Simply find out who it is that you are not allowed to criticise.Voltaire

We, as White people, have been GAGGED!! Then bullied, insulted, demonised, and provoked, until we object and complain. We then get called *dirty names* like Nazi, Racist, White Extremist, etc, etc.

Our weak & corrupt Lib/Lab/Con Politicians are the problem. As of Jan 2021, the UK elections are years away. Check out Populism, and Nationalism ASAP. Become "WHITE WOKE" & Push Back.

Do it today, NOW!

Mr. D. E. Clarke
89 Plantshill Crescent
Tile Hill
Coventry CV4 9RQ
tel. 02476 474166
mob. 07799 256129
daviedclarke@hotmail.co.uk

15th June 06

Dear Sir/Madam

Re; 'Works For Me' issue Thur June 8th 2006 (page 6)

Where to begin?

I have unfortunately been unemployed for some considerable time and am a regular reader of WFM in the capacity of critical observer of the activities of the race relations 'industry'.

Leaving aside the over-arching question of the legitimacy of the subtitle, content, marketing, distribution and funding of WfM, I can no longer allow your editorial opinions as expressed through your letters page to go unchallenged.

You attempt to pass yourself off as an organ for recruitment for the BME clients/customers/users?? of Jobcentres, the obvious implication being that the vacancies therein are directed primarily towards this section of the population. Indeed the text of some of the advertisements indicate that preference is to be given to BME applicants. Fair enough! Or rather it would be if the indigenous white population were to be afforded the same courtesy. How does the idea of a sister publication devoted to the recruitment needs of the indigenous white population grab you? Does it strike you as "racist" even to make such a request. How about an 'Operation White vote' or an Assoc of White Police Officers? How would you feel about the publication of "A White Manifesto"? To object to any of these is plain hypocrisy.

The police service (public money) is one of your principle advertisers/sponsors yet it is now well known that several forces have implemented quota driven racially exclusive recruitment policies to the advantage of black and asian applicants. How this piece of blatant racial preference has escaped the attentions of the CRE, Ms. Shami Chakrabarty, et al defies both logic and the requirements of law. The Royal Navy, (more public money) another of your main sponsors, has a truly bizarre recruitment policy which permits and indeed welcomes Satanists into a ship's company but bars patriotic members of the public if they hold membership of a legal and increasingly popular political party. Would any other army, navy or air force in the world entrust any element of the defence of its country to such a depraved nihilist? Why do you think that is?

Google this: "Dunblane documents 100 year secrecy" to get a clue.

(Any govt. prepared to undertake such an unprecedented and unprincipled cover up is capable of and obviously willing to do anything to its people to cling to power and keep its skeletons very well hidden.)

One particularly offensive side effect of the illegal police recruitment policy outlined above is that it attempts to modify and circumvent our constitutional laws in pursuit of enforced integration. I refer here to The Act of Settlement 1701 (still on statute as it is incapable of repeal and modification) wherein it states:

"no person born out of the kingdoms of England, Scotland, or Ireland, or the dominions thereunto belonging (although he be naturalized or made a denizen), except such as are born of English parents, shall be capable to be of the Privy Council, or a member of either House of Parliament, or enjoy any office or place of trust, either civil or military, or to have any grant of lands, tenements, or hereditaments from the Crown to himself, or to any other or others in trust for him."

An example of an hereditament being the grant of citizenship it therefore follows that the police are now recruiting 'officers' who are not even (and can never be) British Citizens! The constitutional status of the Act of Settlement to this day is established and any purported modification or amendment of it is ultra vires of Parliament. Such attempts are rendered illegal and indeed a treason by both the Declaration and the Bill of Rights as a constitutional statute cannot be altered by a lesser and subordinate Act of Parliament. The Department of Constitutional Affairs have recently confirmed to me in writing that the section of the Act of Settlement quoted above was appended to (illegally) by the British Nationality Act 1985 so it looks like even they concede that all immigration premised on an eventual grant of the hereditament (via the Crown) of British Citizenship has been illegal from 1701 up to 1985. This also means that all 'race relations' Acts and legislations drafted, proposed and passed on that premise are legally voided. Q.E.D.

So having established the constitutional and therefore the judicial illegality of the whole race and diversity industry I must now turn to the part played by your publication.

In your Talking Points column (WfM129) you solicited responses from your readers concerning the British National Party's recent election gains across the country. Responses printed by you were universally negative, ill informed and all too predictably ethno-centric. Although I have missed a few copies and so cannot affirm that the same applies to all your previously printed correspondences or articles. I would assume however that your journalists are bound by the NUJ code of practice which obliges members never to portray any positive image of the BNP.

I request your confirmation or denial in writing that this is the case.

Home  Index



William Wilberforce

On Friday July 26th 1833 as he lay on his deathbed Wilberforce exclaimed: "Thank God that I have lived to witness the day in which England is willing to give £20 million for the abolishment of slavery." (What would that be worth today?) He died three days later.

The Slavery Abolition Bill 1833 passed through the House of Lords, it received the Royal Assent (which means it became law) on 29 August 1833 and came into force on 1 August 1834. On that date slavery was abolished throughout the vast British Empire. The Act automatically applied as new possessions (principally in Africa) subsequently became part of the British Empire.

To know who rules over you. Simply find out who it is that you are not allowed to criticise.Voltaire

We, as White people, have been GAGGED!! Then bullied, insulted, demonised, and provoked, until we object and complain. We then get called *dirty names* like Nazi, Racist, White Extremist, etc, etc.

Our weak & corrupt Lib/Lab/Con Politicians are the problem. As of Jan 2021, the UK elections are years away. Check out Populism, and Nationalism ASAP. Become "WHITE WOKE" & Push Back.

Do it today, NOW!

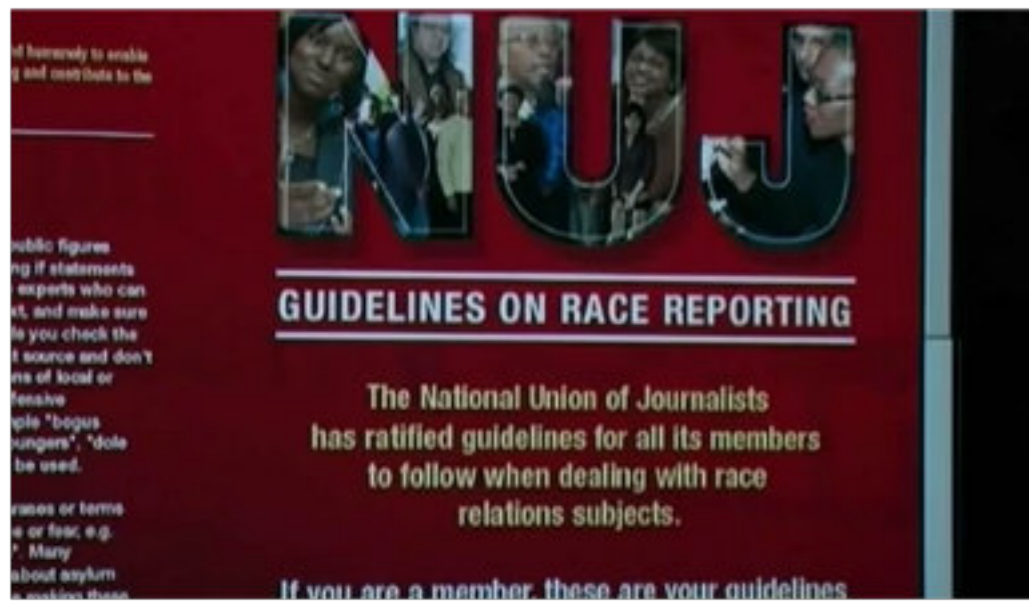

How the NUJ "Dictates" The way their reporters operate when reporting on issues that conflict with the NUJ MARXIST PC agenda. Truth, does NOT matter.

[Open](#)

before the TV watching public whenever a story, event or atrocity contains a muslim component, we on the other hand are denied access to the media. The news broadcasts are nightly saturated with stories concerning the perceived grievances of Britain’s muslims. Why are they granted hugely expensive airtime in which to justify and reinforce their position when the MCB take no part in the democratic process? We as a legally constituted party are rigorously suppressed, censored and imprisoned simply for having the nerve to stand up for what’s left of our own communities.



William Wilberforce

On Friday July 26th 1833 as he lay on his deathbed Wilberforce exclaimed: "Thank God that I have lived to witness the day in which England is willing to give £20 million for the abolishment of slavery." (What would that be worth today ?) He died three days later.

The Slavery Abolition Bill 1833 passed through the House of Lords, it received the Royal Assent (which means it became law) on 29 August 1833 and came into force on 1 August 1834. On that date slavery was abolished throughout the vast British Empire. The Act automatically applied as new possessions (principally in Africa) subsequently became part of the British Empire.

To know who rules over you. Simply find out who it is that you are not allowed to criticise.Voltaire

We, as White people, have been GAGGED!! Then bullied, insulted, demonised, and provoked, until we object and complain. We then get called *dirty names* like Nazi, Racist, White Extremist, etc, etc.

Our weak & corrupt Lib/Lab/Con Politicians are the problem. As of Jan 2021, the UK elections are years away. Check out Populism, and Nationalism ASAP. Become "WHITE WOKE" & Push Back.

Do it today, NOW!

I have read issue 132 and would like you to explain the one-sided ‘debate’ solicited by your request for responses. Your respondent John Way of Birmingham recommends that “those who might feel an affinity with these views are allowed to express why they feel this way...” This is an increasingly heard appeal used disingenuously to satisfy the consciences of those who have no real intention of engaging into debate but need always to cloak their prejudgement in a veneer of fair-mindedness. I know because I’ve tried to ‘engage’, and the resulting exchange quickly descends to the juvenile reliance on dogma when the schizophrenic prerequisites of their utopian, egalitarian theorizing are exposed. It used to be called free speech but if you really mean what you say and want to understand how we feel and prove that this is not just another printed platitude, here’s how it reads to most of the indigenous white population. I believe the best way to illustrate how we in the BNP and most other white people actually feel is to take you through those letters point by point and strip them of cliché.

John Way; Birmingham

“Unfortunately the BNP is a product of our democracy.”

What is unfortunate about it? This is as he so rightly observes, ‘our’ democracy; our principal export to the world, use it or lose it. It annoys the hell out of me that the genocidal rump of Stalinist collectivism is still allowed to manifest itself in the Socialist Alliance parties but if anyone tried to ban them they would find me standing foursquare with them in their defence. If that sounds strange to you it shouldn’t, it is democracy warts ‘n all! Perhaps Mr. Way would recommend theocracy or pharocic rule by divine right as a method of governance.

“...are allowed to express why they feel this way so that the main political parties can have a chance to make them understand...”

Mr. Way would do better asking the BBC, Ch4, the Guardian or ITV News etc. why they don’t allow members of the 4th biggest political party to appear on Question Time, Newsnight etc. When he has had a truthful answer from them he can then start looking at their compliance with the RPA (Representation of the People Act) Then perhaps he can explain to us why representatives of the MCB are wheeled

Politicians run a mile from any debate with British Nationalists, again, I know because I’ve tried. They petulantly withdraw from hustings debates if a BNP candidate is to share the platform. Such debates, when finally arranged, are threatened by roving UAF/Searchlight activists telephoning the venue to threaten the organizers with disruption that “could get a bit nasty”. The activists will then contact the local police to tell them that their threat of a ‘possible’ violent disruption constitutes grounds to prevent the meeting, job done. In one hundred percent of cases it works and the police ban the meeting rather than protect democracy and the people’s right to free association. Mr. Way should wake up and smell the political coffee.

Note also the chilling Orwellian use of the language of coercion, “**make us understand**”? If this was an unconscious use of the term by Mr. Way then I can forgive that as long as he and you accept that you cannot make us do anything. It is indicative of a preconditioned and lazy mind that such subliminal use of language passes for debate or is even considered relevant.

“...the benefits and beauty of living (in) and maintaining a harmonious and culturally diverse society.”

And what exactly will be the benefits to the white community when they find themselves out-bred into a physical minority in their own homelands sometime around 2050/60? (Office of National Statistics & National Audit Office figures by the way, not mine.)

What benefit or improvement results from the dilution of English law and constitutional monarchy by the eventual incorporation of Sharia law? None whatsoever, it may be a suitable basis to run an 11th century desert fiefdom but has no place in the UK.

What benefit accrues to the African and Asian countries who export their brightest citizens from their talent pool, their wellspring of potential reform, to the UK to prop up a mismanaged health and public sector?

What benefit (to us) from having an alien religion supplant the indigenous belief system?

What benefit from suffering the practice of barbaric religious animal slaughter on UK soil?

What is so urgent about permanently changing the face of the UK that it requires the subjugation of free expression, free association and the demolition of a thousand years of constitutional governance that has been imitated (but never bettered) around the world and all against the wishes of the un-consulted British?

If Mr. Way could supply us with a list of tangible and measurable benefits rather than the alleged, the nebulous and the totally unquantifiable we would all be able to make our own minds up. It is often quoted that immigrants provide a net financial contribution to the economy (£2.5billion) as the justification for their presence. Quite apart from the fact that the treasury figures were instantly exposed as bogus, selective and heavily doctored wishful thinking, it would still not be sufficient reason for the government to ask indigenous white Britons to shut up and pay up for their own racial extermination by stealth.

Your publication for so long as it continues, should confine itself to matters in which it purports to have expertise, it should not be yet another state sponsored mouthpiece for the massive treason being carried out against the white population.

Sharmila Dhillon London;

Sharmila observes:

“...but I don't think it's as serious as the media make it out to be.”

Here at least we see acknowledgment of, if not the reasoned methodology behind the frenzied response of the print and broadcast media to the BNP.

“...if this (further integration) isn't encouraged by our government there's a strong chance that we'll see the BNP enjoy increased support in the future.” Please understand our laws and constitution. It is not the given role of government to aid illegal immigration and forced integration in any manner. Where has she been for the past 30/40 yrs? Every facet of life has had the attentions of the race relations and 'diversity industry' forced upon it with threats of fine, forfeit, dismissal, imprisonment or public approbation through the bought media. From nursery children (remember the Sure Start Scheme suggestions about “baa baa green

sheep” and Lewis Carrol's Piglet!!) to 'offensive' porcelain pigs on an arrested pensioner's window sill, this intrusive enforcement of political correctness is widely ridiculed and deeply resented along, quite logically, with those who promote it.

She presumably cannot accept the possibility that it is the accelerating pace of this forced acceptance of mass immigration by Nu-Labour in particular that is waking the indigenous white population to their coming fate. The very last thing they want is more of the same. The nu-labour regime in particular is in full thrall to the directives of the MCB, CRE, EU et al and has brought this upon itself.

“...by those who feel disenfranchised from mainstream society and blame immigration for their problems.”

More sixth form sociology clichés. Native British people see their problems in much wider terms than your correspondent's simplistic analysis. Yes immigration is a massive and legitimate concern. Anyone who would deny that legitimacy as a manifestation of 'institutional racism' has no business making pronouncements upon it as such denial removes any chance of debate at a stroke. Our concerns are many and interlinked, for example...

Let's deal with some fundamentals.

Our islands are our only home lands, we have no other.

We assert our primacy in the islands of the UK and the right to own this land and to exercise the birthright of the protection of our laws and conventions in perpetuity.

Magna Carta is still in force and was never a document granting rights to the people of Britain, it was a recognition (effectively at the point of the people's sword) by the Monarch of rights we have always had. Through it the executive power of Monarchy and Parliament are forever held as subject to the consent of the people in perpetuity. Parliament cannot dissolve itself nor can it abrogate its powers.

This is fundamental stuff in case the penny hasn't dropped!

And most crucial of all;

The people are sovereign in their parliament, not ministers, not the Lords, not the monarch and most definitely not the European Council of Ministers or the Muslim Council of Britain.

Being subject to the same physical constraints as the rest of the universe means that there is a natural physical limit to the population that any defined area can support. This seems obvious but why have the Green Party silently dropped any policy reference to an actual figure? Answer; the current UK population is



William Wilberforce

On Friday July 26th 1833 as he lay on his deathbed Wilberforce exclaimed: "Thank God that I have lived to witness the day in which England is willing to give £20 million for the abolishment of slavery." (What would that be worth today ?)

He died three days later.

The Slavery Abolition Bill 1833 passed through the House of Lords, it received the Royal Assent (which means it became law) on 29 August 1833 and came into force on 1 August 1834. On that date slavery was abolished throughout the vast British Empire.

The Act automatically applied as new possessions (principally in Africa) subsequently became part of the British Empire.

To know who rules over you. Simply find out who it is that you are not allowed to criticise.Voltaire

We, as White people, have been GAGGED!! Then bullied, insulted, demonised, and provoked, until we object and complain. We then get called *dirty names* like Nazi, Racist, White Extremist, etc, etc.

Our weak & corrupt Lib/Lab/Con Politicians are the problem. As of Jan 2021, the UK elections are years away. Check out Populism, and Nationalism ASAP. Become "WHITE WOKE" & Push Back.

Do it today, NOW!

untenable and only sustained and made governable by the promise of continuing input of oil derived energy.

That promise was never anyone's to give and is about to be broken as oil production hits peak (North Sea output peaked in 1999) and from this point on we begin riding the down-slope of the energy graph. No effective substitute looks likely to appear in time to replace oil derivatives for road transport fuel, huge agrichemical use, power generation, off grid home heating, rail, air travel. All is dependent on oil and on any planetary system there is only ever one chance for an energy based society to evolve, it's effectively a 1-Shot deal. This, friends, is it. You are living at the very peak of human civilisation. Forget the post apocalyptic rise of the cockroach, it was only ever science fiction. Oil should have been used sparingly to ensure our successful transition to ultimate sustainability of the human race into and through the coming millennia. It turned out to be the road not taken and we have instead prepared for ourselves an unappetizing banquet of cold, hard consequences.

What is the likely scenario as that fact begins to dawn on the British and international public together with the instant removal of vast amounts of speculative 'capital' from the stilt walking financial markets as everyone finally twigs that there is nothing viable left to invest in and moreover nothing to invest with? What realisable assets do you suppose will pay those billions of worthless, 'built on a promise' pensions worldwide? How will ambulances run? Who will fuel and fund the police or the construction industry or manufacturing? Commuting will not be viable, holidays and foreign homes will be abandoned as ridiculously wasteful concepts. (for the likes of us) Tap water will find its true value before it eventually ceases to flow and we commence our transition to the harsh reality of a low/no energy subsistence society.

Against this background what do you suppose will be the reaction of the English (or indeed any other race) when they are asked to move aside and let another unassimilable racial group take over the land and enter the competition for rapidly disappearing resources? They will ask the inevitable question, "why should we?" and no-one could decry them for it. It is survival instinct pure and simple, a consequence of natural law and nature's laws are not broken with impunity. **Let us also remember that MI5 reported to cabinet recently that Britain as it stands is only four square meals from wide scale civil disturbance.**

Katherine Kemp East Ham

"The BNP are a despicable bunch"

No explanations or reasoning given but she's entitled to her opinion however bigoted; She then goes on to repeat the tired old soar;

"...our government doesn't do enough to create harmony between communities."

How many state and lottery funded 'inter-faith research projects', Gambian Women's Enterprise Groups and Cohesion Funds will it take? We've had forty years of this and no visible advantage has yet accrued to the native British therefrom. Why on earth should we be expected to join in the clamour for more?

"...it's the BNP... that fuels the fire through fear and lies."

The respondent is merely demonstrating the journalistic tyranny of language. For the loaded phrase 'fear and lies' substitute the phrase "raising valid concerns" and the sting is instantly drawn from the sentence. You in your capacity as editor should be above such unsophisticated linguistic tricks employed solely to raise emotional response to a sentence that lacks valid content. You at least should be able to spot and exclude them.

I would be grateful if Mrs Kemp would provide specific examples of BNP 'lies'. I will be more than happy to investigate and respond to them. Incidentally, on the subject of lies let's not exclude good old fashioned corruption. It might be appropriate at this point to mention that we have and want no 'ties' to big business donors, greasers or bagmen looking for peerages. Our party accounts were recently pronounced by a senior Electoral Commission official as "the only ones that give us no cause for concern". That didn't stop Barclays and HSBC bowing to pressure from the Daily Telegraph (prop. Richard Desmond, pornographer and Labour donor) and withdrawing banking facilities from the party. They don't seem to have a problem stashing money from the bank robbers of the IRA though do they!

I would venture to suggest that recent comments from Shahid (= the martyr) Malik 'MP' about the BNP marching around Bradford and Oldham being the cause of the recent rioting and racial tensions are a textbook example of alarmist lying. For information, the BNP haven't marched anywhere since 1998 and have no intention of so doing. Get your facts right Mr. Malik, the chances of an apology, retraction and correction? Nil.

"...then retreat to the sidelines and watch community divides broaden."

We do not retreat anywhere because there is nowhere to retreat to, although I note that the scion of the left Billy Bragg retreats to his agreeable six bedroomed manse in 'hideously white' Dorset rather than Brent East. In Coventry we stood in the most heavily diversified ward just to make that very point; that we consider no part of this country a 'no-go area' and will stand where and when we choose. The Keighley police have in desperation called on the local BNP representatives for help in resolving the multi-racial chaos when endless consultations and fora with unelected ethnic 'community leaders' have been utterly unable to meet the challenge.



William Wilberforce

On Friday July 26th 1833 as he lay on his deathbed Wilberforce exclaimed: "Thank God that I have lived to witness the day in which England is willing to give £20 million for the abolishment of slavery." (What would that be worth today ?)

He died three days later.

The Slavery Abolition Bill 1833 passed through the House of Lords, it received the Royal Assent (which means it became law) on 29 August 1833 and came into force on 1 August 1834. On that date slavery was abolished throughout the vast British Empire.

The Act automatically applied as new possessions (principally in Africa) subsequently became part of the British Empire.

To know who rules over you. Simply find out who it is that you are not allowed to criticise.Voltaire

We, as White people, have been GAGGED!! Then bullied, insulted, demonised, and provoked, until we object and complain. We then get called *dirty names* like Nazi, Racist, White Extremist, etc, etc.

Our weak & corrupt Lib/Lab/Con Politicians are the problem. As of Jan 2021, the UK elections are years away. Check out Populism, and Nationalism ASAP. Become "WHITE WOKE" & Push Back.

Do it today, NOW!



William Wilberforce

On Friday July 26th 1833 as he lay on his deathbed Wilberforce exclaimed: "Thank God that I have lived to witness the day in which England is willing to give £20 million for the abolishment of slavery." (What would that be worth today ?) He died three days later.

The Slavery Abolition Bill 1833 passed through the House of Lords, it received the Royal Assent (which means it became law) on 29 August 1833 and came into force on 1 August 1834. On that date slavery was abolished throughout the vast British Empire. The Act automatically applied as new possessions (principally in Africa) subsequently became part of the British Empire.

To know who rules over you. Simply find out who it is that you are not allowed to criticise.Voltaire

We, as White people, have been GAGGED!! Then bullied, insulted, demonised, and provoked, until we object and complain. We then get called *dirty names* like Nazi, Racist, White Extremist, etc, etc.

Our weak & corrupt Lib/Lab/Con Politicians are the problem. As of Jan 2021, the UK elections are years away. Check out Populism, and Nationalism ASAP. Become "WHITE WOKE" & Push Back.

Do it today, NOW!

and actively rake for it wherever it has been secreted. Ignorance of the cause of ones demise was never a defence in nature neither is it one in law, politics or demographics. Our constitution was wrought from a thousand years of experience and bloodshed so that the citizen and subject of the Monarch is protected by Magna Carta and the Bill of Rights in any rightful or necessary challenge to either government or Monarch.

Those without the stamina or critical ability to sort fact from fiction in a government's arguments and actions invariably take the lazy way out and believe the corrupted output of the media for their dose of the currently fashionable group-think. It also conveniently provides the path of least resistance, is a cheap distraction from reality, satisfies the desire for a mental wallpaper of conformity to cover the cracks in an increasingly disparate world and wastes a lot of money in pursuit of not much at all. The last thing they will find in the media however is the truth.

Summary;

Well, you requested dialogue as did your correspondents, so here it is. I hope that this may provide some insight into the real and perceived problems the indigenous white population is facing. They are entirely legitimate and yet BNP supporters and the growing membership are being arrested and jailed for having the nerve to raise the warning, sacked for mere membership of the party, homes are raided and hard drives stolen for Special Branch use in building up a picture of inter party 'networks'.

The major parties actively and strategically collaborate with the media and each other in their vain attempts to suppress the BNP. Principle counts for nothing, statesmanship has been banished and replaced by an inadequate collection of 'change managers', focus groups, bagmen, backslappers and career sycophants, toothless select committees, a grossly politicised pseudo-paramilitary police force, a rogue judiciary that is outwith the law, an executive (cabinet) run by a cabal of ex and current Marxists, suspected paedophiles, business and Bilderberg Group placemen (who they?) plus a functional illiterate, the list is practically endless unlike the patience of the British. They have no shame at all in holding the continuation of each other's gravy trains as more important than the interests of the very people who put them there and whose sufferance and unwillingness to be provoked has been the real factor in keeping UK society stable.

I can make no apology for the length of this letter and there are a hundred and one everyday examples of anti-white discrimination I could have included but space and a vengeful rouge judiciary precludes their inclusion, it is also too easy to fall into editorialised speechifying!

I formally request your response to the above. For my part, I have no objection to this being forwarded to your correspondents for their response should they

"The govt doesn't help this by announcing that immigration is out of control and the Home office is in disarray."

She just doesn't get this democracy thing does she? To the British it is of much greater concern that their government tried (yet again) to hide their dysfunction by withholding such information! We give the government of the day the authority, duty and finance to control and defend our country's borders amongst other things. We have an absolute right to know if, why and how it is dysfunctional. What's the problem with this? It's part of the accountability process she's asking for but yet she bemoans the results of that process? I'm sorry but I'm getting really confused with her train of logic here!

That immigration is out of control cannot be a matter for dispute when the past three Home Secretaries admit they "haven't a clue" how many immigrants have entered, left or still remain in the country!

"...needs to be some accountability from our government."

Katherine, there is a means of accountability, it is called a ballot box although the sanctity and security of these is now the subject of several court cases following the disgraceful activities in Birmingham of six muslim councillors last year.

The contempt for democracy and the franchise displayed by this and countless similar acts around the country cuts many English voters to the core. It offends the memory of the price they paid to obtain and keep the sanctity of the ballot box and what it represents. Such disrespect will not easily be forgotten. We have an example before the courts currently in relation to the ward in Coventry mentioned above and shabby state backed attempts to get the Sandwell and other declared results overturned. Banana republic? Well yes, it appears so!

However one can only cast an informed vote on the basis of correct information and the true facts of government performance have forever been deeply hidden. Therefore if you want the facts one must be prepared to find out for oneself. The problem is that it takes much time, effort and expense wading through countless government and EU web pages. How many have actually read the Draft EU Constitution? 250 plus pages without a single laugh in it! Not many I'll bet, yet this treacherous document is almost wholly dedicated (save for a cursory preamble about 'human rights') to promoting the advance of global trade interests and sacrificing what vestige of national independence, identity and self determination we yet hold.

All corrupted government will try to appropriate ever more power to itself. Additionally, it must forever be borne in mind that "The price of freedom is eternal vigilance." Therefore it is every citizen's duty to make himself aware of the truth

choose to avail themselves of the opportunity to justify their position with facts and reasoning. I have no naïve expectation that any part of this reply will be submitted for publication, yours and their request for, and tolerance of debate therefore is about to be tested.

In anticipation of your acknowledgement and soonest reply,

Yours with concern,

Mr. Davied E. Clarke & family

After presenting this thing to the job centre manager and pulling it apart (politically) I read them the riot act and vowed to take it as far as necessary.

Suddenly (from about October 06) this bi-weekly, expensively printed piece of blatant racial preference failed to appear. Enquiries to their offices elicited the response that it was "no longer viable to produce" whatever the hell that means. It's expensively produced because it derives its income from the marketing budgets of the armed forces, police forces, local government recruitment ads, British Gas, BT etc, the usual quota obsessed entities.

The point is, it's no longer distributed in Coventry, it would be interesting to know if anyone else is taking this up and if they've had any success.

Thanks for picking this one up and publicising it on your site. Top stuff! »—> 'Works for Me' (Earl's Court, London, 21st October 2006)

For our children's futures

Dave C.



DIVERSITY for DUMMIES

It's just basic Arithmetic. To say you want more Ethnic Diversity, is exactly the same as saying that you want 'Less' of the ethnicity that you have already got. How RACIST is that ? In 2011, native British Whites became a minority group in London. The same is true of a number of other large British cities. Am I a Racist ? Absolutely not ! I want more ethnic minorities every bit as much as they want more of me. How much is that ?

When any minority is 'Positivly' selected. It means that many White People have been 'Racially Profiled' to be sent to the back of the queue.



William Wilberforce

On Friday July 26th 1833 as he lay on his deathbed Wilberforce exclaimed: "Thank God that I have lived to witness the day in which England is willing to give £20 million for the abolishment of slavery." (What would that be worth today ?)

He died three days later.

The Slavery Abolition Bill 1833 passed through the House of Lords, it received the Royal Assent (which means it became law) on 29 August 1833 and came into force on 1 August 1834. On that date slavery was abolished throughout the vast British Empire.

The Act automatically applied as new possessions (principally in Africa) subsequently became part of the British Empire.

To know who rules over you. Simply find out who it is that you are not allowed to criticise.Voltaire

We, as White people, have been GAGGED!! Then bullied, insulted, demonised, and provoked, until we object and complain. We then get called *dirty names* like Nazi, Racist, White Extremist, etc, etc.

Our weak & corrupt Lib/Lab/Con Politicians are the problem. As of Jan 2021, the UK elections are years away. Check out Populism, and Nationalism ASAP. Become "WHITE WOKE" & Push Back.

Do it today, NOW!

Whites need not apply

Multiculturalism

RACE AND CULTURE:

<http://www.spectator.co.uk>

September 2005.

The ideology of multiculturalism is theoretically meant to build a more tolerant, inclusive Britain.

But in practice it is a deeply racist concept, one that judges people by their ethnic origin and thereby promotes division in our society. The very basis of multiculturalism is a contradiction of the democratic principle that everyone should be treated equally, regardless of their background or skin colour. Through its obsession with racial identity, this pernicious creed actually encourages discrimination.

The first anti-racism campaigners in Britain fought for equality, demanding government action to combat overt racial prejudice in employment and the provision of public services, especially housing. But since the early 1980s the agenda of anti-racism has changed. The goal is no longer equality but the very opposite: the institutional recognition of racial separation.

Two decades ago multiculturalism was the preserve of the extreme Left in local government and Ken Livingstone's Greater London Council. Everything from the recruitment of staff to the award of grants was driven by ethnic considerations. Tragically, what was once on the municipal fringe is now part of the political mainstream. In the name of celebrating diversity, we now have a civic culture that has elevated racial difference into a system of governance. Right across the British state, institutions are driven by a concern to address the competing demands of different ethnic groups. And in the process any ideas of fair treatment and equal access have been lost.

In the publicly funded arts, for instance, ethnicity is now a key factor in the making of grants. Almost 10 per cent of bodies subsidised by the Arts Council describe themselves as black or ethnic minority organisations. 'British culture is not a single entity; we should rightly speak of British cultures,' says the Arts Council. So Kala Sangham, the Bradford-based Asian arts company, received £1.5 million to establish a new centre of excellence for South Asian arts. Similarly £2.75 million is earmarked for the East Midlands African-Caribbean Arts and Apna Arts to build a black arts centre in Nottingham.

Individuals can benefit too. There is now an explicitly discriminatory book prize for the black or Asian writer of the year, presided over by the Arts Council. At theatres in Birmingham, Ipswich and Manchester, the posts of writer-in-residence are reserved for 'blacks and Asians' while, in the name of 'positive action', the Nottingham Playhouse, Manchester Royal Exchange and West Yorkshire Playhouse have recruited three black directors.

In the same vein, a bursary of £30,000 was recently given to the Nottingham visual artist Hetain Patel, as part of the Decibel diversity programme, 'a national initiative to raise the profile of artists who are from African, Asian or Caribbean backgrounds'. Taxpayers will be pleased to know the vital purpose to which this cash will be put. Mr Patel decorates his body with materials such as henna and kanku paste, which are used in traditional Hindu ceremonies. His work is said to 'demonstrate the displacement of Indian culture throughout the UK'.

Anyone suspected of not fully embracing cultural diversity is threatened with an axe.

Earlier this year, the Lake District National Authority sought to drop its guided walks organised by volunteer rangers because the participants were 'too white and middle-class', while a mountain rescue team in the Pennines and an RNLI crew on the Severn were reportedly both turned down for lottery funding because they did not do enough to help the disabled and ethnic minorities.

Yet there is not a murmur of protest at the open racial bias towards blacks and Asians which is now routine across the public sector. In the Metropolitan Police, applications from ethnic minorities are prioritised, which means that white male recruits may have to wait three years before being interviewed.

One of the ingenious ways the Met has avoided breaking the law in respect of direct racial discrimination is by introducing new criteria to fast-track applicants, including the ability to speak a second language and 'knowledge or experience of a community group'.

Ethnic favouritism is also rife at the BBC, where cultural diversity has become a corporate fixation. One BBC manager admits, 'I had a guy write to me the other day asking for advice on how to start a career at the BBC; he had studied at a red-brick university and done a postgraduate course at City University.

I told him to forget about trying the BBC; as a middle-class Anglo-Saxon male you've got no chance.'

Even some of the ethnic minorities can feel aggrieved by this approach. Anvar Khan, a freelance presenter, has said, 'No self-respecting black or Asian person wants to be pushed ahead because of their colour. It's patronising. If anything, I



William Wilberforce

On Friday July 26th 1833 as he lay on his deathbed Wilberforce exclaimed: "Thank God that I have lived to witness the day in which England is willing to give £20 million for the abolishment of slavery." (What would that be worth today ?)
He died three days later.

The Slavery Abolition Bill 1833 passed through the House of Lords, it received the Royal Assent (which means it became law) on 29 August 1833 and came into force on 1 August 1834. On that date slavery was abolished throughout the vast British Empire. The Act automatically applied as new possessions (principally in Africa) subsequently became part of the British Empire.

To know who rules over you. Simply find out who it is that you are not allowed to criticise.Voltaire

We, as White people, have been GAGGED!! Then bullied, insulted, demonised, and provoked, until we object and complain. We then get called *dirty names* like Nazi, Racist, White Extremist, etc, etc.

Our weak & corrupt Lib/Lab/Con Politicians are the problem. As of Jan 2021, the UK elections are years away. Check out Populism, and Nationalism ASAP. Become "WHITE WOKE" & Push Back.

Do it today, NOW!

think the BBC's push to recruit and promote ethnic minorities will mean that the really bright black and Asian people will leave the BBC to go and work for companies where people don't assume they've made it because of their colour.'

Every area of public life is riddled with discrimination and segregation masquerading as 'positive action'. Social housing is racially divided, with more than 140 black and ethnic minority housing associations trumpeting their services to non-white clients.

Apart from the police, many other recruitment campaigns work openly in favour of ethnic minorities. The Museums' Association annually offers ten traineeships and two bursaries to ethnic minority graduates to work in the museum sector. The National Archives is now advertising a ten-month 'Positive Action Internship' worth £15,300 to 'individuals of African, African-Caribbean, Asian or Chinese descent'. The Inland Revenue and Civil Service are following the same route, providing specialised work-experience placements for ethnic minority students, while Birmingham City Council offers traineeships worth £16,000 a year for 'black and minority ethnic individuals'.

So-called 'cultural awareness' has also led to racial fragmentation in healthcare, education and social services. The machine of state is now awash with specialised outfits such as the Drug Action Team for the Bangladeshi and Somali communities in Tower Hamlets, or the Black African and Caribbean Mental Health Consortium in Brent, which is presently recruiting an office manager. 'All applicants must be of black African/Caribbean origin,' states the advertisement. Similarly the Leicestershire Community Projects Trust is seeking an Asian Drugs Worker, for which 'a high level of cultural sensitivity and fluency in at least one South Asian language is essential'. And the Aids organisation the Terrence Higgins Trust is searching for a £29,000-a-year Senior Black Gay Men's Officer.

Nowhere is free from such divisions. In childcare, the government recently announced that it wanted to see all pre-nursery provision 'responsive to the needs of local black and minority ethnic families' through the purchase of 'culturally sensitive toys, books and resources for staff'. In Bristol there is the Kuumba community resource centre, which provides a black arts programme, the Jumoke nursery 'in a culturally sensitive environment', the Bwerani multicultural and inclusive play centre, and the Sankore Afrikan Caribbean lending library.

In a typical piece of multicultural nonsense, Ken Livingstone's adviser on race policy, Lee Jasper — who has advocated the creation of black-only schools — says that 'you have to treat people differently in order to treat them equally'. But this relentless focus on difference is only breeding grievance, resentment and social dislocation. Where racial identity lies at the centre of public policy, there can be no sense of shared belonging, no spirit of national unity. Urban Britain is in danger of becoming nothing more than a landmass inhabited by competing ethnicities.

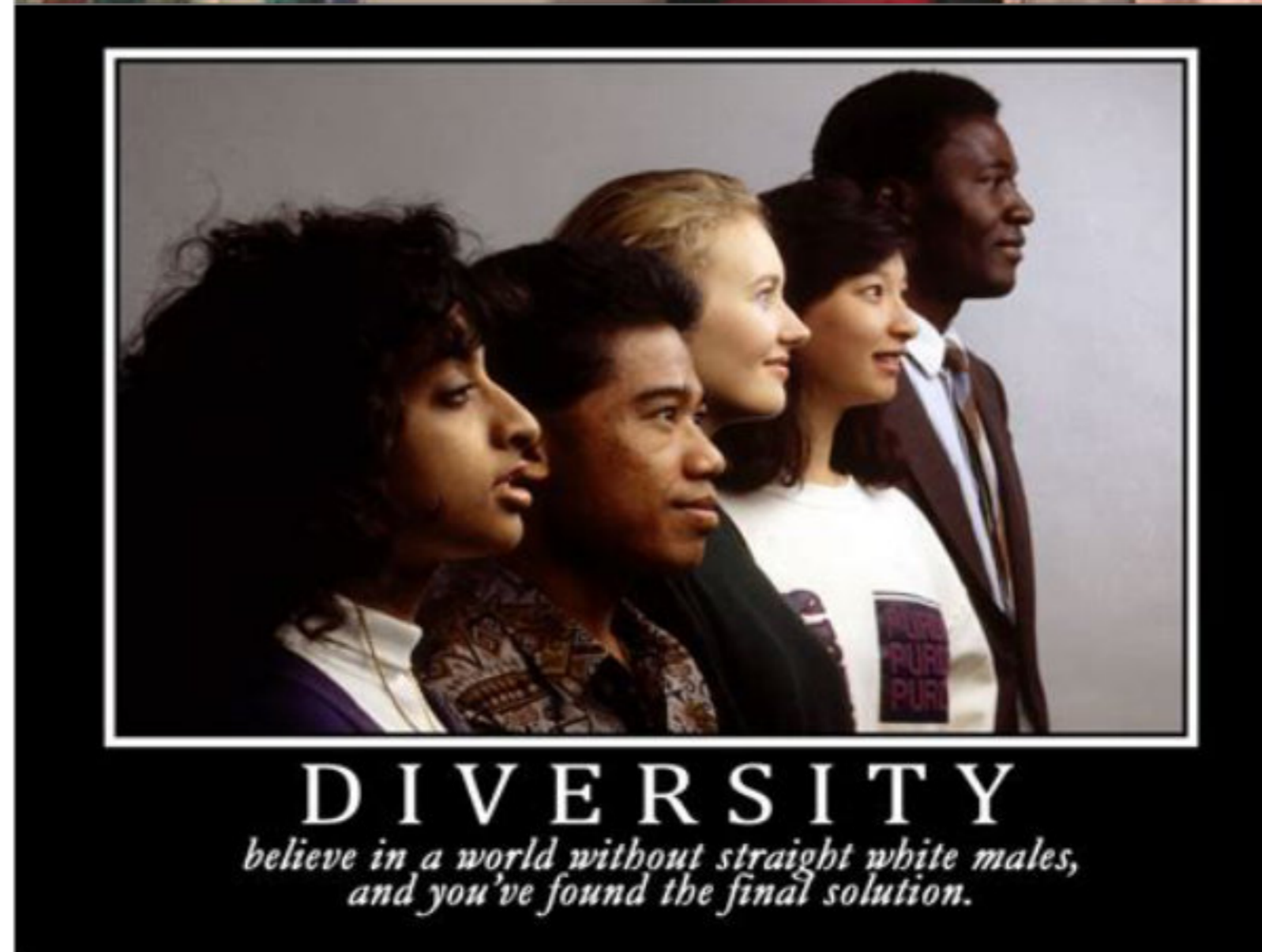

William Wilberforce
On Friday July 26th 1833 as he lay on his deathbed Wilberforce exclaimed: "Thank God that I have lived to witness the day in which England is willing to give £20 million for the abolishment of slavery." (What would that be worth today ?)
He died three days later.

The Slavery Abolition Bill 1833 passed through the House of Lords, it received the Royal Assent (which means it became law) on 29 August 1833 and came into force on 1 August 1834. On that date slavery was abolished throughout the vast British Empire. The Act automatically applied as new possessions (principally in Africa) subsequently became part of the British Empire.

To know who rules over you. Simply find out who it is that you are not allowed to criticise.Voltaire

We, as White people, have been GAGGED!! Then bullied, insulted, demonised, and provoked, until we object and complain. We then get called *dirty names* like Nazi, Racist, White Extremist, etc, etc.

Our weak & corrupt Lib/Lab/Con Politicians are the problem. As of Jan 2021, the UK elections are years away. Check out Populism, and Nationalism ASAP. Become "WHITE WOKE" & Push Back. **Do it today, NOW!**

Multiculturalism As a Tool To Divide And Conquer

Multiculturalism As A Tool To Divide And Conquer

The Layman's Primer

by Louis Beam

<http://www.louisbeam.com>



No nation is born multicultural. Multiculturalism is an unnatural as well as unhealthy condition that can only afflict states in national decline. A multicultural state carries in it's genes the seeds of eventual national destruction.

All multicultural nations will be found to be in a state of political, moral, economic and social decay. Greed and corruption will characterize the government coupled with oppressive measures directed against citizens. Lies and deceit will be stock and trade of media, politicians, and educational institutions. Such are the bellwethers of a multiculturalist advent.

In modern times multiculturalism is instituted from the top down as an elitist ruling class tool used to play one or more racial or ethnic groups against another. The ensuing cultural melee serves the political designs, economic goals and power needs of elitist rulers and their sponsors. This technique was developed by Marxist ideologues who used multiculturalism in Russia to divide and conquer resistance to the institution of a communist state. The end result of their successful takeover was the murder of thirty million humans in the Soviet Union alone. Many more elsewhere.

The same internationalist cabals who sponsored Lenin, Trotsky, and Stalin as the multicultural leaders of the Soviet state from their banking houses in New York, similarly sponsor the multicultural leaders of the United States, Canada, and Europe today. An interlocking network of foundations such as Ford and Carnegie, international banking empires such as Rockefeller and Rothschild, and government agencies firmly in their control work in tandem with controlled propaganda outlets such as the New York Times, CBS, and Hollywood, to promote, foster, and institute multiculturalism today. While the examples used in this essay deal primarily with the United States the same process with the same methods is being employed elsewhere. This of itself is prima facie evidence of a cabal which promotes multiculturalism as a tool to achieve its objectives.

Multiculturalism is being used as a hammer to forge the compliant people who will compose the obedient states of the New World Order. As a weapon of post modern political warfare multiculturalism has few equals, which, thus explains its use currently against all of Western Europe, the United States, Canada, Australia, and New Zealand. Deliberate fragmentation of these nations and the resultant loss of national identity and purpose into politically disharmonious units, serves as a stepping stone to world government. And who will compose that world government? A ruling class consisting of an "economic hierarchy" that replaces the philosophy of the nineteenth century "natural hierarchy." A force that views countries and the people that live in them first as economic targets to be exploited, and second as military targets to be defeated if they resist.

One must not let himself be confused by the window dressing of willing dupes from the left who are most often, but not always, seen as the spokesmen for the glories of multiculturalism. Liberal supporters of multiculturalism amount to nothing more than opportunist parasites riding on the back of a social fungus attacking the body politic. While some incoherent liberals have been spokesmen for multiculturalism, they should not be viewed as representing other main stream liberals any more so than do so-called conservatives like Bob Dole and Newt Gingrich speak for constitutionalists and populists. The real stimulus, unseen elitist who promote multiculturalism as a tool of warfare, are themselves anything but liberal, progressive, or democratic. Rather they are global social tyrants who seek more power, more wealth, and more control over people--and they could care less what the politics are of those they seek to rule.

Elitists schemers envision a dictatorial world government composed of forcibly federated states, which, properly speaking, are police states without borders. The United Nations will serve as the store house front and public face of those who from behind the scenes manipulate world events.

Economically envisioned is a global workers plantation overseen by transnational corporations who have no more concern for the human rights of those who produce their products or services than Stalin did for his miserable workers. Vassal states are to produce goods and insure compliance of their subjects by defining all opposition to the borderless police state as terrorism. Thus will be the good times. In bad times, when elitist multinational corporations are unable to maintain



William Wilberforce

On Friday July 26th 1833 as he lay on his deathbed Wilberforce exclaimed: "Thank God that I have lived to witness the day in which England is willing to give £20 million for the abolishment of slavery." (What would that be worth today ?) He died three days later.

The Slavery Abolition Bill 1833 passed through the House of Lords, it received the Royal Assent (which means it became law) on 29 August 1833 and came into force on 1 August 1834. On that date slavery was abolished throughout the vast British Empire. The Act automatically applied as new possessions (principally in Africa) subsequently became part of the British Empire.

To know who rules over you. Simply find out who it is that you are not allowed to criticise.Voltaire

We, as White people, have been GAGGED!! Then bullied, insulted, demonised, and provoked, until we object and complain. We then get called *dirty names* like Nazi, Racist, White Extremist, etc, etc.

Our weak & corrupt Lib/Lab/Con Politicians are the problem. As of Jan 2021, the UK elections are years away. Check out Populism, and Nationalism ASAP. Become "WHITE WOKE" & Push Back.

Do it today, NOW!

control, the armed might of NATO will be used to enforce obedience by non-compliant states.(1)

METHODS USED AND THEIR EFFECT

Just as television commercials are run by those who will profit from their airing, multiculturalism is fostered upon a country by its sponsors who intend to benefit from its acceptance.

Those who sponsor multiculturalism are properly called multiculturalists and generally will be found to be those people with the least amount of personal culture appertaining to them. As a dying tree drops its leaves and is attacked by fungus and worms of decay, so to is a nation set upon by multiculturalists. The dominate culture is attacked from all sides. This is not so much a product of maliciousness as necessity. By vilifying, leveling, and weakening the dominant culture, an environment is created for social, political, and economic turmoil which produces change that will benefit the sponsors of a multiculturalist state. If the government and news media relentlessly pursue issues of race, gender, and diversity in preference to the real issues that need to be addressed, there will be an increasing division of society along the same lines. Which is exactly what the sponsors of multiculturalism want.

Social instability, caused by a steady erosion of standards and values, coupled with a scramble over dwindling economic opportunities by conflicting ethnic groups, produces precisely the alienation and conflict needed to implement a multicultural state. Further, the lack of common standards and values leads to personal disorganization, resulting in unsociable behavior. This is the life support system of a multicultural state. In a word: anomie.

As a political tool multiculturalism has several applications. It is used to prevent a national consensus among the electorate. The confluence of divergent life views, cultures, beliefs, religions, ethnic habits, etc. insures a swirling river of discontent upon which the multiculturalist rides. It is a perfect method of ensuring that there can never in the future be accord, unity, and a common agreed upon destiny among those ruled. Multiculturalism represents a basic form of divide and conquer, to the benefit of corrupt government and its sponsors.

Multiculturalism is likewise a financial tool used to socially and economically level a targeted population. When implemented, it becomes in fact a battle over scarce resources and shrinking economic opportunities, with government weighing in on the side of cheap labour. A continual flow of impoverished workers is insured through immigration (both legal and illegal), who by working for less compensation continually drive wages down. For the vast majority of citizens the standard of living will not increase, but rather constantly decrease.

As a general rule:

The amount of multiculturalism in any society is directly proportional to the corruption at the top of a political system and inversely proportional to national unity.

**This means:
multiculturalism will have succeeded in so much
as the country has failed.**

Multiculturalism can further be used as "transitional tool" to take a targeted population from one form of government to another. When a political condition of greed, massive corruption, and diversity of objective is coupled to a social condition of drugs, violence, and discontent, therein exists the perfect environment for governmental change to a system that more closely serves long term interests of ruling elitists. Seeing that both the problem and solution are provided by the same people makes the CIA's importation of some one hundred billion dollars worth of cocaine and other drugs into the United States understandable. While at the same time explaining FBI, ATF, and other, more secretive federal government agencies involvement in domestic terrorism or its cover-up. Suddenly, that which erroneously was previously thought to be unrelated events show their common thread and purpose.

Within the deleterious milieu of multiculturalism exists the propaganda opportunity for re-education of the people into a more malleable entity. A targeted population will be shaped mentally by new forms of public education in the schools, media indoctrination, and by elitist pronouncements. Thus placed in a crucible of economic necessity and social pressure, once free citizens become despondent masses, adjusting to and accepting fundamentally changing national circumstances as a matter of expedient survival. For the reticent, conformity by force will ensue in the form of legal penalties disguised as ant-drug, anti-terrorism, or anti-hate laws. All of this leading toward what George Orwell so aptly predicted in his book 1984:

"Almost certainly we are moving into an age of totalitarian dictatorships. An age in which freedom of thought will be at first a deadly sin and later on a meaningless abstraction."

A society is being spawned where those with the most unsociable behavior, deviant lifestyle, or personal failures are given the most by government. This is no accident! It is not government blundering, nor is it misguided liberalism; it is exactly what it is by design, purpose, and objective. A program advocated by both Republican and Democratic administrations for the elitist backers of both are the same. It is the program of a government which has fallen firmly into the hands of evil forces. Failure to recognize this salient point will result in endlessly chasing after tangents, or needlessly blaming those who have no power to change the



William Wilberforce

On Friday July 26th 1833 as he lay on his deathbed Wilberforce exclaimed: "Thank God that I have lived to witness the day in which England is willing to give £20 million for the abolishment of slavery." (What would that be worth today ?)

He died three days later.

The Slavery Abolition Bill 1833 passed through the House of Lords, it received the Royal Assent (which means it became law) on 29 August 1833 and came into force on 1 August 1834.

On that date slavery was abolished throughout the vast British Empire.

The Act automatically applied as new possessions (principally in Africa) subsequently became part of the British Empire.

To know who rules over you. Simply find out who it is that you are not allowed to criticise.Voltaire

We, as White people, have been GAGGED!! Then bullied, insulted, demonised, and provoked, until we object and complain. We then get called *dirty names* like Nazi, Racist, White Extremist, etc, etc.

Our weak & corrupt Lib/Lab/Con Politicians are the problem. As of Jan 2021, the UK elections are years away. Check out Populism, and Nationalism ASAP. Become "WHITE WOKE" & Push Back.

Do it today, NOW!

current direction of events. Anger directed toward liberals,(2) Blacks, or people of colour is wasted. Reorganization of the government from the bottom up would be productive.

Multiculturalism, like drugs, is an insidious weapon. Both destroy the heart and fabric of a people. All ties to family, community, and one's people as a whole are destroyed by these two opiates of the human mind. Both are sponsored from the top down by one world elitists bent upon creating a world order who's power is such that its subjects possess no potential for resistance.

By its very nature every emerging police state seeks to harness both the power of the state and the people to its will. When calls are made for support of cryptic slogans such as war on crime, drugs, terrorism, hate, poverty, etc. what is really meant is "grant power to the state and applaud the rape of your freedom." In sum: multiculturalism is another program designed to create the subjects of a Police State Without Borders. When coupled with the "war on drugs" and "war on terrorism," Orwell's world of endless war is realized. It would be their world, their orders, and nothing new, for a lust for despotism is as old as mankind himself.

The anti-thesis of multiculturalism is moral, religious, and cultural solidarity among the people of a nation. Belief in one's self and the ultimate good of his people. A cohesiveness that produces a national vision, with set boundaries of acceptability and unacceptability in the affairs of a nation, while allowing for the natural differences in men. Multiculturalism as a tool of warfare becomes impotent and rejected in such an environment.

A necessary first step toward recovery is to look at politics, social policy, and government emanating from Washington D.C. with new eyes, unclouded by a lifetime of false information and deception propagated by elitist sponsors. Pretending any longer that the bought and paid for political prostitutes in Washington D.C. represent you or anyone you know is tantamount to cutting your own wrist with a razor blade. Self-destructive behavior may qualify one for government "protected class status" under diversity laws--but it will not save you, your family, or your nation.

America, Canada, and most of Europe are ruled by politicians about whom the best that can be said is that they are men of ill repute, each out to loot the state. One thing is clear, the American ruling elite of today are far closer in ideological viewpoint to world government ruled by a privileged few than it is to the world of the American Revolution or the Constitutional Convention of 1789. Yet still, the spirit of 1776 lives on in this land. For once again rebellion to tyrants in obedience to God is afoot. Listen closely and in the distance you can hear the ring of liberty's bell calling gallant sons and noble daughters to her aid. They know no left, nor right, only treason. And they will not fear to answer. Let tyrants tremble. And though the heavens fall, let there be justice.

Foot Notes:

1. Those who imagine the United Nations in and of itself as a military threat are naive or deliberately misled. Global elitist would never trust the U.N. with an army other than one on loan. Because of the U.N.'s diversity there is too great a potential for some member states taking as serious elitist propaganda of "democratic" rule and "equality" then using any military that might exist without elitist sanction. NATO on the other hand is controlled by the United States government, which is the chief force behind the establishment of the New World Order. It is, and will remain in the foreseeable future, the army of choice for insuring compliance.

A quick change of hat from green to blue will make NATO troops "UN Forces" when such need is sanctioned by elitists.

2. Indeed liberal thinkers such as Daniel Brandt have written far more eloquently about the deleterious effects of multiculturalism than the present writer. Brandt's essay Multiculturalism and the Ruling Elite is a must read for those interested in the subject.



William Wilberforce

On Friday July 26th 1833 as he lay on his deathbed Wilberforce exclaimed: "Thank God that I have lived to witness the day in which England is willing to give £20 million for the abolishment of slavery." (What would that be worth today ?) He died three days later.

The Slavery Abolition Bill 1833 passed through the House of Lords, it received the Royal Assent (which means it became law) on 29 August 1833 and came into force on 1 August 1834. On that date slavery was abolished throughout the vast British Empire. The Act automatically applied as new possessions (principally in Africa) subsequently became part of the British Empire.

To know who rules over you. Simply find out who it is that you are not allowed to criticise.Voltaire

We, as White people, have been GAGGED!! Then bullied, insulted, demonised, and provoked, until we object and complain. We then get called *dirty names* like Nazi, Racist, White Extremist, etc, etc.

Our weak & corrupt Lib/Lab/Con Politicians are the problem. As of Jan 2021, the UK elections are years away. Check out Populism, and Nationalism ASAP. Become "WHITE WOKE" & Push Back. **Do it today, NOW!**



William Wilberforce

On Friday July 26th 1833 as he lay on his deathbed Wilberforce exclaimed: "Thank God that I have lived to witness the day in which England is willing to give £20 million for the abolishment of slavery." (What would that be worth today ?) He died three days later.

The Slavery Abolition Bill 1833 passed through the House of Lords, it received the Royal Assent (which means it became law) on 29 August 1833 and came into force on 1 August 1834.

On that date slavery was abolished throughout the vast British Empire. The Act automatically applied as new possessions (principally in Africa) subsequently became part of the British Empire.

To know who rules over you. Simply find out who it is that you are not allowed to criticise.Voltaire

We, as White people, have been GAGGED!! Then bullied, insulted, demonised, and provoked, until we object and complain. We then get called *dirty names* like Nazi, Racist, White Extremist, etc, etc.

Our weak & corrupt Lib/Lab/Con Politicians are the problem. As of Jan 2021, the UK elections are years away. Check out Populism, and Nationalism ASAP. Become "WHITE WOKE" & Push Back. **Do it today, NOW!**



Domesticating People

24 Jun 2007

Morgana19le66fay@aol.com

In my last article ' Farming people ' I showed you how the Labour government is using people as a commodity to make money for the State in taxation and fines.

However farming people just like farming animals can only be done by domesticating wild animals in the first place, as our ancestors did in ages past.

Did one of our ancestors one day enter the forest and capture a wolf to use as a hunting dog or guard dog , did they go onto the moors or highlands and start milking an auroch , a fierce ancestor of our Highland cattle standing 6 foot tall. No, it had to be done in stages maybe by taking a wolf cub or auroch calf and bringing it up amongst people .

To domesticate wild animals they must be kept in suitable conditions so they do not wish to revert back to wild life. Well fed and watered so the foraging and browsing is not needed , shelter so the nomadic lifestyle is a thing of the past. Protected from other animals makes life easier for them. Shelter, food and protection will keep the animal happy , breeding will increase the herd and as the young are brought up in domesticity it becomes part of their instinct , the wild life is forgotten and now something to be feared.

Our rural ancestors just as country people today are like those wild animals of old, they live with nature , work the soil and hunt in the forest and rivers for food . Living in small village communities they have a sort of freedom to run their lives, no real stress , healthy food and time to reflect .These rural people are self sufficient , independent minded , definitely not what a government wants its people to be.

So how does the government change this.

First they must get these independent people together in large groups to keep an eye on them and they do this by enticing these people into towns and cities with the promise of easier and better paid work hence the industrial age had its benefits to the government of the day.

Money for food and shelter in cities is more tempting to people than the hard work and uncertainty of rural life. Better living conditions with water on tap

How it feels trying to warn people about the true nature of government

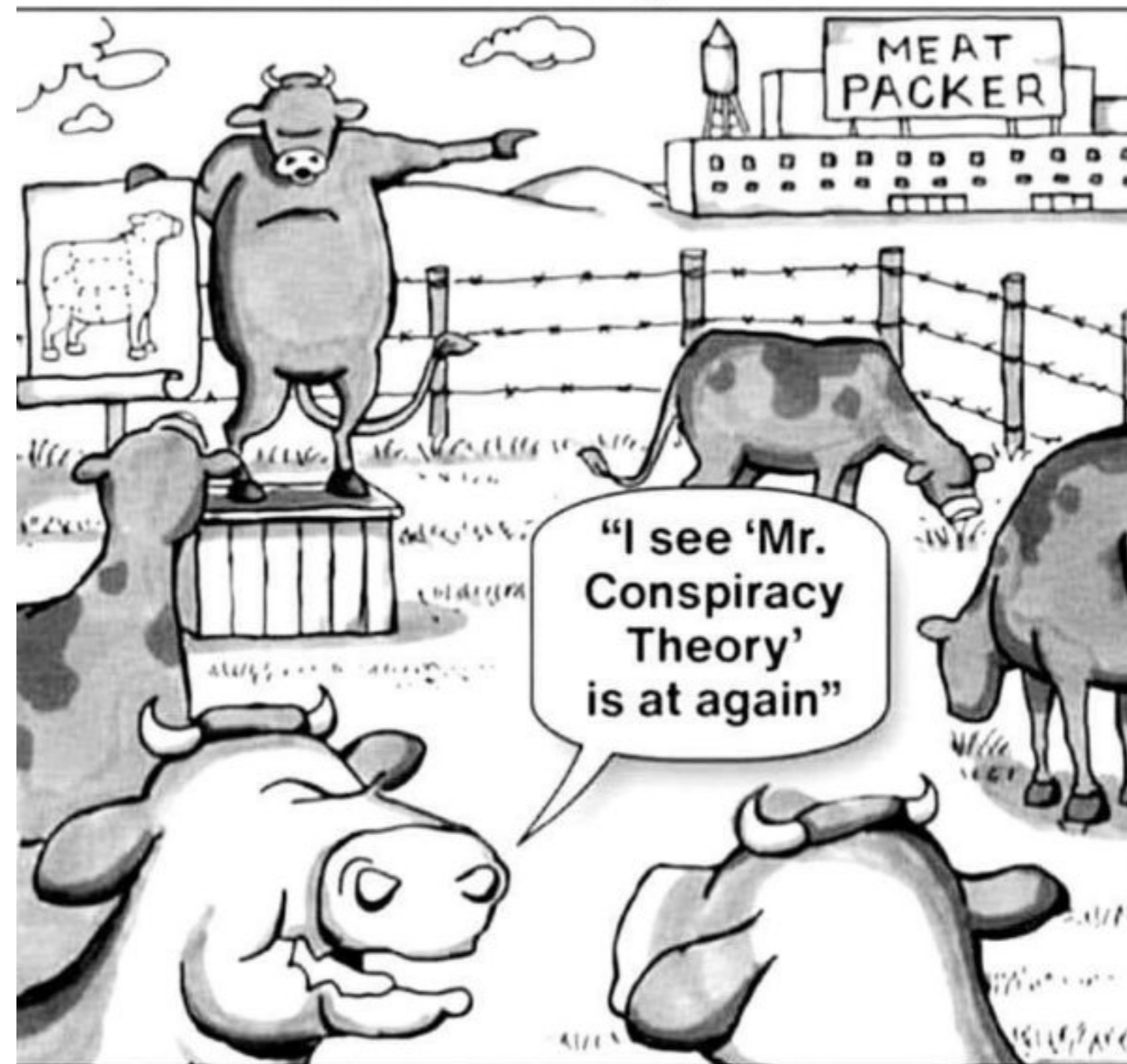

electricity and gas , smaller territory to contend with where shops , schools and entertainment is localised with public transport ensures people do not want to revert back to the ' wild life '.

This is all well and good but to carry out these jobs that have lured people to the cities they need education to work the machines and to run and upkeep these cities.

Education as the saying says "is a dangerous thing" and it certainly is if domesticating people is your goal.

Unlike animals , humans have a greater brain capacity and this can mean organising themselves to ask for more of a say in the government and an improvement in conditions.

To allay this the humans must have comfortable conditions to stop them leaving their homes to take part in any disorder, that's why we have 24 hour television to keep them amused , interactive programmes they can get involved in supposedly giving them choice in what is going on. In front of the television is where they can be brainwashed into thinking the world is alright and a lovely place to live. Cheap , easily obtainable alcohol and drugs will ensure they are gullible to this propaganda



William Wilberforce

On Friday July 26th 1833 as he lay on his deathbed Wilberforce exclaimed: "Thank God that I have lived to witness the day in which England is willing to give £20 million for the abolishment of slavery." (What would that be worth today ?) He died three days later.

The Slavery Abolition Bill 1833 passed through the House of Lords, it received the Royal Assent (which means it became law) on 29 August 1833 and came into force on 1 August 1834. On that date slavery was abolished throughout the vast British Empire.

The Act automatically applied as new possessions (principally in Africa) subsequently became part of the British Empire.

To know who rules over you. Simply find out who it is that you are not allowed to criticise.Voltaire

We, as White people, have been GAGGED!! Then bullied, insulted, demonised, and provoked, until we object and complain. We then get called *dirty names* like Nazi, Racist, White Extremist, etc, etc.

Our weak & corrupt Lib/Lab/Con Politicians are the problem. As of Jan 2021, the UK elections are years away. Check out Populism, and Nationalism ASAP. Become "WHITE WOKE" & Push Back.

Do it today, NOW!

and in no fit state to leave their home.

Whilst watching television they will be enticed to buy items they do not really want and lured into having credit cards and loans to buy what they see the unreal television people have.

Not all of these city people are so easily fooled they need other tactics. Stress, that great killer of city people. A work colleague , many years ago , had so much stress with his job he actually broke down in Heathrow airport and was literally unable to function. The manager director had to go and collect him from the bench where he was sitting .

Put people under financial stress and they have to go on the defensive to protect their nice life style , their cars , homes, luxury goods , constantly raising taxes and interest rates does this ; bringing in new laws and regulations ensure small businesses are constantly having to 'fork out' more cash to comply with all these government regulations eating into their profits , creating stress.

I'm talking about stress for a reason , a brain receives many signals , sound, vision , smell , touch and the brain reacts to them all , collating the information and acting on it. Consequently the brain is very busy particularly if it is trying to focus on something in particular ; with all this going on the attention span of the brain becomes short.

This is what the government want , a people unable to focus on important issues so the wool can be easily pulled over their eyes. That's why the government finds it easy to hide bad news with good news as people are unable to focus on important issues any more , they cannot read between the lines, they have lost that capability.

Stress is not just financial pressure it's job related too, bombard the worker with targets , uncertainty about their work future, get their spouses out to work too ; this means the likelihood of less relaxing domestic conditions at home when the domesticated humans finally go home after long hours of working. Even parking their cars outside their little houses is stressful as our country fills up with people far more than the country's infrastructure can cope with.

Constant building of houses ensure people live on top of each other causing friction between them in these cramped surroundings as well.

Global warning concerns a lot of people as they worry about the future of their children but is it a reality .Weather goes in cycles , Norway and Canada recently had unusually bad snowfall , Britain at the moment is having torrential rainfall this seems to suggest the worry of global warming is unfounded , plenty of experts out there say global warming is not a threat.

But that concern is still something the human brain has to consider. As is the

threat to personal well being with murder and violent crime on the increase . Ethnic gangs shooting each other on the streets is no longer confined to the TV , it is a reality the city people have to contend with.

Protection of the family is a major concern of the city dweller especially as successive governments have disarmed the public and made it more likely they and not their assailant will get the prison sentence.

With the advent of war on Iraq and Afghanistan , something the Prime Minister not only failed to consult the public but also parliament, we suffered bombings in the very cities where domesticated Britons live by those aliens that have been introduced into our country without the public's consent bringing terror and more stress for our brain.

RAF Typhoon warplanes are at constant readiness to intercept jets which air traffic controllers believe have been seized by terrorists intent on a September 11-style atrocity.

A cause for concern as you fly off for your relaxing holiday abroad.

Silly , petty criminalisation of the domesticated people continues unabated by the government who now are even considering prosecuting for cruelty to pet spiders, octopuses and restaurant lobsters under animal welfare plans . All these silly laws , over 300 since Labour came to power , put pressure on the domesticated people's brain.

British people however have a safety valve against stress and it is humour . British humour is unlike any other it relies on making fun of people's differences aka 'piss taking'. It has served us well in wartime and times of stress. How many serious moments have been lightened by a comic quip aimed against someone to relieve the tension.

This safety valve has been noticed by the Labour government and removed by the introduction of the draconian race and religious hatred laws , no longer can British people make fun of someone else as it can be now construed as threatening to ethnic minorities however trivial the quip ; more stress for the domesticated people to contend with.

Just as the herd of cattle in the farmer's field could suddenly decide to look for pastures new if a leader should emerge so could the domesticated city dweller. To counter this the farmers mix the herd with new stock which also may have such a leader but the leaders will soon fight amongst themselves to gain superiority. Any thought of escape back to the wild is forgotten whilst the fight for ' pecking order ' goes on.

In the human cities this is achieved by bringing in immigrants of a different race or



William Wilberforce

On Friday July 26th 1833 as he lay on his deathbed Wilberforce exclaimed: "Thank God that I have lived to witness the day in which England is willing to give £20 million for the abolishment of slavery." (What would that be worth today ?) He died three days later.

The Slavery Abolition Bill 1833 passed through the House of Lords, it received the Royal Assent (which means it became law) on 29 August 1833 and came into force on 1 August 1834. On that date slavery was abolished throughout the vast British Empire. The Act automatically applied as new possessions (principally in Africa) subsequently became part of the British Empire.

To know who rules over you. Simply find out who it is that you are not allowed to criticise.Voltaire

We, as White people, have been GAGGED!! Then bullied, insulted, demonised, and provoked, until we object and complain. We then get called *dirty names* like Nazi, Racist, White Extremist, etc, etc.

Our weak & corrupt Lib/Lab/Con Politicians are the problem. As of Jan 2021, the UK elections are years away. Check out Populism, and Nationalism ASAP. Become "WHITE WOKE" & Push Back.

Do it today, NOW!

religion , each group now fights for supremacy with no time or inclination to tackle the government, they cannot focus on the real issues any more ; their overworked brain can no longer focus.

Health is another factor in domesticating humans, rural people had good health , plenty of fresh air , physically demanding work kept them fit and healthy fresh food to eat but once they entered our cities all this ended , jammed into factories using cancer causing chemicals, never seeing the sun , breathing in factory fumes and repetitive boring jobs in front of machines .Cheap and nasty manufactured food , dirty hospitals , an inept national health service ensure the health of the city dwellers continues to deteriorate.

The re-introduction of tuberculosis into Britain by immigrants , who face no medical checks at our borders, is encouraged by the government who ended TB inoculation for our school children in 2005.

Constant health scares , bird flu , mad cow disease , the constant finding of some food source which has a detrimental effect on health all add to the mayhem , the build up of stress.

All these health problems are detrimental to the brain and are part of the planned subjugation of domesticated people.

To ensure the balance of this domesticity is not upset the government starts at an early age making children go to school earlier and earlier getting them away from the comfort of the family home, test, tests and more tests put these young children under stress at an early age , when they grow up stress will already be part of their life. It has been suggested by so called experts that more than a million children have mental health problems, a doubling of the number in a generation.

When the young leave school , unemployment is the norm yet still migrant workers flood Britain encouraged by our government giving no future for our children who turn to alcohol and drugs in despair , some drugs have been made legal by the government and no real attempt is made to clear the streets of drug dealers, why should they when the total pacification of the public is sought.

Have you noticed most active of nationalist parties activists are generally those unemployed or retired , they are free from a lot of this government fabricated stress so are getting back the brain's ability to focus on what is important.

That is why the non-working elderly people are put under pressure too , vital medicines are being withheld , macugen and drugs for alzheimers disease for example , this is their stress the inability to look after themselves these elderly will be put into care homes where they can be controlled with medication , anti depressants and the like.

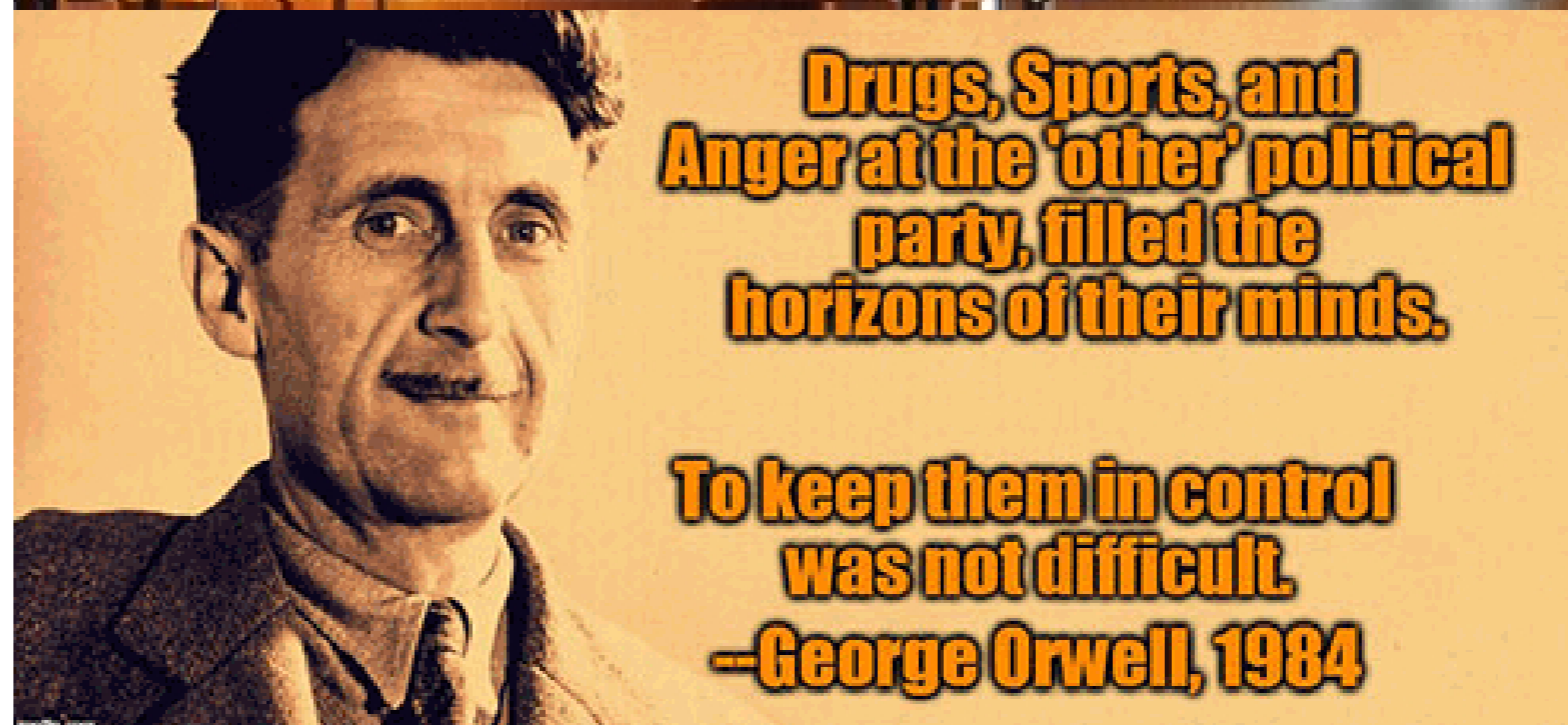
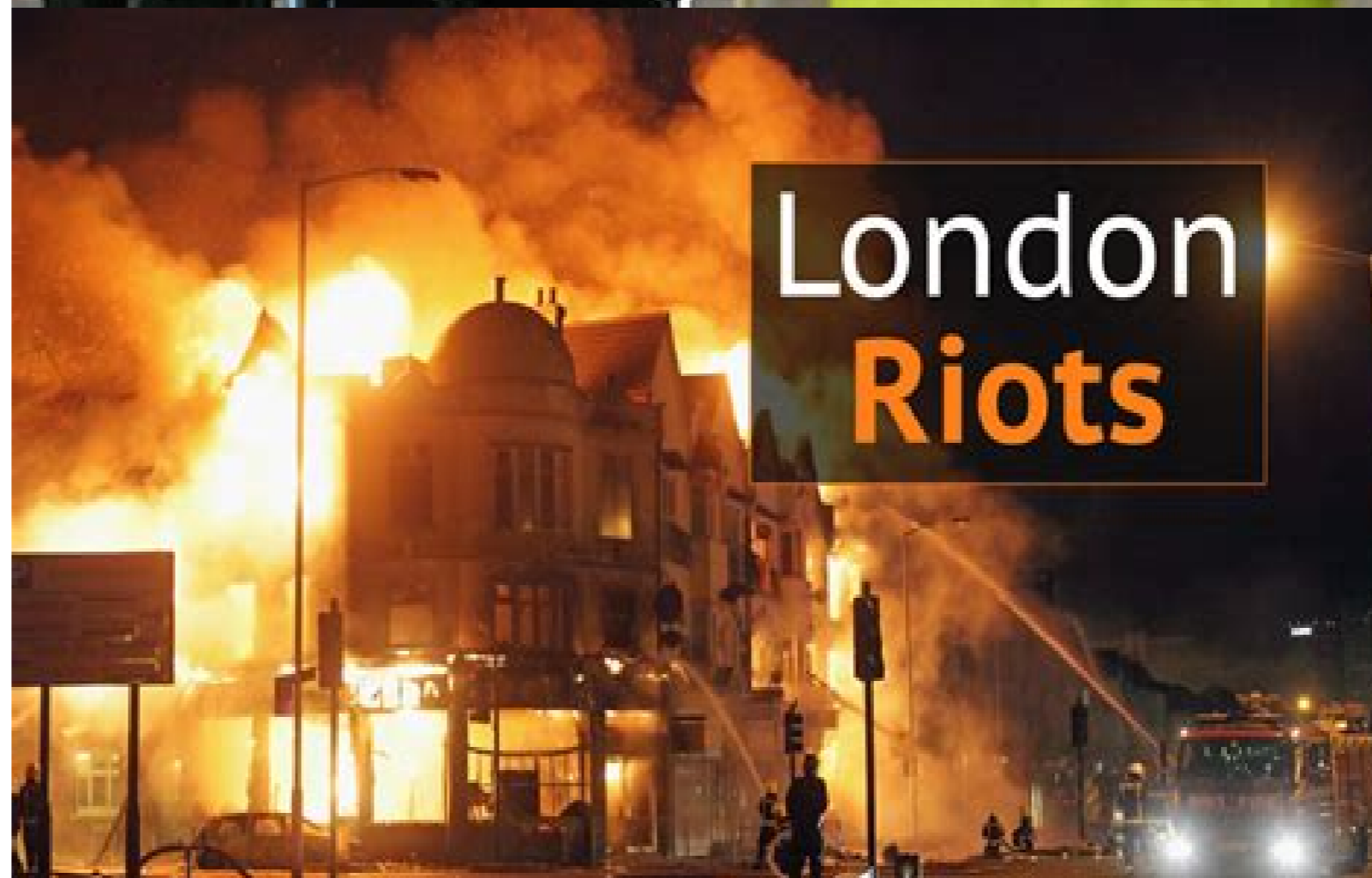

"Every record has been destroyed or falsified, every book rewritten, every picture has been repainted, every statue and street building has been renamed, every date has been altered. And the process is continuing day by day and minute by minute. History has stopped. Nothing exists except an endless present in which the Party is always right." ~ George Orwell, 1984.



William Wilberforce

On Friday July 26th 1833 as he lay on his deathbed Wilberforce exclaimed: "Thank God that I have lived to witness the day in which England is willing to give £20 million for the abolishment of slavery." (What would that be worth today ?) He died three days later.

The Slavery Abolition Bill 1833 passed through the House of Lords, it received the Royal Assent (which means it became law) on 29 August 1833 and came into force on 1 August 1834. On that date slavery was abolished throughout the vast British Empire. The Act automatically applied as new possessions (principally in Africa) subsequently became part of the British Empire.

To know who rules over you. Simply find out who it is that you are not allowed to criticise.Voltaire

We, as White people, have been GAGGED!! Then bullied, insulted, demonised, and provoked, until we object and complain. We then get called *dirty names* like Nazi, Racist, White Extremist, etc, etc.

Our weak & corrupt Lib/Lab/Con Politicians are the problem. As of Jan 2021, the UK elections are years away. Check out Populism, and Nationalism ASAP. Become "WHITE WOKE" & Push Back.

Do it today, NOW!



William Wilberforce
 On Friday July 26th 1833 as he lay on his deathbed Wilberforce exclaimed: "Thank God that I have lived to witness the day in which England is willing to give £20 million for the abolishment of slavery." (What would that be worth today ?)
 He died three days later.

The Slavery Abolition Bill 1833 passed through the House of Lords, it received the Royal Assent (which means it became law) on 29 August 1833 and came into force on 1 August 1834. On that date slavery was abolished throughout the vast British Empire. The Act automatically applied as new possessions (principally in Africa) subsequently became part of the British Empire.

To know who rules over you. Simply find out who it is that you are not allowed to criticise.Voltaire

We, as White people, have been GAGGED!! Then bullied, insulted, demonised, and provoked, until we object and complain. We then get called *dirty names* like Nazi, Racist, White Extremist, etc, etc.

Our weak & corrupt Lib/Lab/Con Politicians are the problem. As of Jan 2021, the UK elections are years away. Check out Populism, and Nationalism ASAP. Become "WHITE WOKE" & Push Back. **Do it today, NOW!**



The price of everything you buy goes up with inflation but pensions do not keep pace they only rise by about a £1 every year , one shopping item rise in price will wipe out the increase in pensions putting the elderly under pressure even though they no longer work. We have already have had peoples pensions stolen by the government putting those better off elderly into financial uncertainty.

From a three year old being forced into school to the elderly being denied medicines they need , people's brains are being controlled and deflected away from independent thought.

The government does not act alone they have accomplices : doctors , MP's , police , senior civil servants and judges etc all putting people under pressure , for this they receive high financial reward .

Not for them is living in crowded council estates , not for them is walking our dangerous streets at night or for that matter during the day, not for them is travelling on our inefficient public transport, not for them is the hospital waiting lists , not for them is low wages and not for their children are schools where the main language used is alien to indigenous people of Britain.

For these people are the farm workers .



Guerilla War ? The elite's war on us, by immigrant proxy

David Hamilton

Tuesday, 9th September 2008

Guerilla War ? The elite's war on us by immigrant proxy

According to the Mail on Sunday, which obtained the official statistics of 37 police forces under the Freedom of Information Act, there is an offence involving a knife every 24 minutes of the day in England. There were over 5,500 serious crimes involving knives in just three months this year - one every 24 minutes.

That is 55 knife-related murders and more than 2,000 stabbings.

[And that figure does not include data from Northamptonshire, Somerset and Lincolnshire - Ed] The newspaper explained:- London, Manchester and Birmingham are the worst-affected areas, while West Yorkshire, Merseyside and Northumbria police forces were also in the top 10.

During just April, May and June this year, the Metropolitan Police recorded 1,580 offences more than quarter of the national total. A breakdown reveals 17 people are stabbed or robbed at knife point in the every day and by July 2008 twenty teenagers had been murdered in London. The total for the whole of last year was 26 shooting or stabbing killings among young people. Our elites have imported gang warfare while pretending that the immigrants were soft, sentimental like pets and if we were nice to them they would be nice to us! Common sense tells people that immigrant areas are no longer safe for white people to live in. But to obfuscate the facts, a 9 percent reduction in crime is claimed by the police, with the violent crime sector being reduced by 8 percent. As is now well known, in areas with much crime many people do not report burglaries or muggings because experience tells them that the police will do nothing about it. Less than half of such crimes are reported. It is a deceit visited upon the population by a government who cannot control crime because they are acolytes of the religion of equality, and no racial or ethnic group can be more inclined to certain crimes than any other.

The elites have a variety of other motives for their treachery, and I will mention one or two in passing. But radical egalitarianism is the principal reason that they cannot face the fact that some of the black-on-white knife murders appear to be racially motivated. No matter. These are simply not classed as racial incidents. This is the case with the Sidcup murder of the young Harry Potter actor, Robert Knox. Two blacks were arrested. And it was the case in the murder of Ben Kinsella, brother of East Enders actress Brooke Kinsella, where four blacks were

arrested. The protest march of six hundred in North London against knife crime had a few black girls but no black males. The ruling elite - politicians, media, the police and the courts - are covering-up constant racist violence against indigenous people.

So the latest spate of white murders are not comprehended by the average person (who, in any case, has been brainwashed into thinking that victims of racist violence all look like Stephen Lawrence). This is nothing new. In or around 1979 a Metropolitan police report on black mugging was withdrawn to prevent a clamour for control of immigration or even a white backlash. Even as far back as 1959 two reports from the London Metropolitan Police and the West Midlands Police expressed concern at the growing number of crimes of violence being carried out by some of the newly-arrived West Indians. The rate per head of population was something like four times that committed by indigenous people. The West Indian family has broken down and now many black boys involved in street crimes, including murder, do not have a father to control them, and some have an inherited disposition towards violence.

Crime in Jamaica is similar, and holiday makers can not go our for a stroll from their hotels, just as in Sub-Saharan Africa, Detroit or New Orleans! An important but unregarded fact is the way the elites, who literally hate their own people, stir up racial hatred against us from the other communities. **Ever since immigration began there has been constant one-sided propoganda about the slave trade to turn blacks against whites. They fill their minds full of hatred for us.**

Professor Kai Murros

England Is At WAR



Professor Kai Murros
[England Is At WAR](#)

"The low intensity ethnic warfare your elites have waged against you for decades, has now reached new levels"

[Open](#)

Anyone who has lived and worked in an inner-city knows that the main reason cited for mugging white people by blacks is slavery. To keep this hidden the police reports stopped taking ethnicity into account. Why are calls for control of immigration treated with such vehement approbation? Because our elites follow an ideology that is at odds with reality and tells them that immigrants are better than us and enrich us.

To the innocent people who think this is an accident, I repeat some words from Dele Oguntimojou, an African lawyer working in London:- (you) do not know how the youth in the poor African village is being seduced by lush advertising to shed his native dress for blue jeans; to retune his ears from the traditional hi-life to the



William Wilberforce

On Friday July 26th 1833 as he lay on his deathbed Wilberforce exclaimed: "Thank God that I have lived to witness the day in which England is willing to give £20 million for the abolishment of slavery." (What would that be worth today ?)

He died three days later.

The Slavery Abolition Bill 1833 passed through the House of Lords, it received the Royal Assent (which means it became law) on 29 August 1833 and came into force on 1 August 1834. On that date slavery was abolished throughout the vast British Empire.

The Act automatically applied as new possessions (principally in Africa) subsequently became part of the British Empire.

To know who rules over you. Simply find out who it is that you are not allowed to criticise.Voltaire

We, as White people, have been GAGGED!! Then bullied, insulted, demonised, and provoked, until we object and complain. We then get called *dirty names* like Nazi, Racist, White Extremist, etc, etc.

Our weak & corrupt Lib/Lab/Con Politicians are the problem. As of Jan 2021, the UK elections are years away. Check out Populism, and Nationalism ASAP. Become "WHITE WOKE" & Push Back.

Do it today, NOW!



William Wilberforce

On Friday July 26th 1833 as he lay on his deathbed Wilberforce exclaimed: "Thank God that I have lived to witness the day in which England is willing to give £20 million for the abolishment of slavery." (What would that be worth today ?)
He died three days later.

The Slavery Abolition Bill 1833 passed through the House of Lords, it received the Royal Assent (which means it became law) on 29 August 1833 and came into force on 1 August 1834. On that date slavery was abolished throughout the vast British Empire. The Act automatically applied as new possessions (principally in Africa) subsequently became part of the British Empire.

To know who rules over you. Simply find out who it is that you are not allowed to criticise.Voltaire

We, as White people, have been GAGGED!! Then bullied, insulted, demonised, and provoked, until we object and complain. We then get called *dirty names* like Nazi, Racist, White Extremist, etc, etc.

Our weak & corrupt Lib/Lab/Con Politicians are the problem. As of Jan 2021, the UK elections are years away. Check out Populism, and Nationalism ASAP. Become "WHITE WOKE" & Push Back.

Do it today, NOW!

drum and bass of hip-hop and Brit pop. Even now the British Council is busy across Africa training the next generation of immigrants in the language of the destination country.(1) In November 2006 it was reported that the Government were advertising for immigrants to come here from terrorist countries.

Discovered in the embassy in Pakistan a Foreign Office pamphlet declared: Multicultural Britain - A Land of Immigrants. It encouraged immigrants to come here telling them of the preferential treatment they get under the Human Rights Act and well-paid jobs. The Foreign Office put it in embassies across the world. 2 July 2008, the Daily Mail revealed:- British girls as young as 12 are being forced into prostitution by migrants. Children from ordinary families are groomed by older men before being pimped around the uk to have sex up to 20 times a night.

They are raped and often drugged, according to police. Officers have identified syndicates of Iraqi men throughout the uk behind the exploitation. A government report said internal trafficking was an emerging issue and it should no longer be assumed young victims of sex exploitation were smuggled from abroad. A UK human trafficking centre intelligence report says girls as young as 12 are taken from town to town and controlled with threats and assault. In one operation, 32 victims were identified in the sheffield area alone. All were aged 12 to 15 and had been raped. In another study, police say girls are given to a life of exploitation, waking up in anonymous towns, unable to contact family and with no way out. Figures released at the end of a six-month crackdown on people traffickers showed 167 victims were rescued across Britain and Ireland and 528 suspected traffickers were arrested. Latest estimates by police are that there may be as many 18,000 trafficked victims that are forced to work as prostitutes. Iraqi men?

This is a form of guerilla warfare carried out against our children. These are the people our elites work so hard to get here, and if they are illegal give them amnesties. If you have seen the Blairs houses you will know why. Cherie was a Human Rights lawyer. Home Office minister Vernon Coaker said:-It is difficult for us to determine what the size of that problem is but it's something we are aware of and we have concerns about. That is all they care about our children. The now normal event of knifings and murders amongst the black population should be no surprise. Practical people have pointed this out to the utopian idealists since mass immigration, or what Lord Elton in 1965 called The Unarmed Invasion (2), began. Those who wanted controls on practical, common-sense grounds were attacked mercilessly by tyrannical political, cultural and intellectual elites who suppressed debate and stifled the genuine worries and fears of innocent people. It is not left versus right. The first House Of Commons debate was appropriately on the 5th of November, 1954. It was an adjournment debate and called by John Hynd Labour MP for Sheffield (Attercliffe). There had been questions asked in the House prior to this.

He stated, One day recently 700 embarked from Jamaica without any prospect of work, housing or anything else. He also commented on the colour bar in Sheffield dance halls because of knife fights involving blacks. Throughout the 1950s honourable MPs were worried about the consequences. Norman Pannell MP Liverpool (Kirkdale), addressed the Conservative conferences of 1958 and 1961 on the perils of admitting criminals and the sick. In 1961 the debate was stage-

managed to stop MP.Cyril Osborne(Louth) speaking. He stood outside in the rain handing out off-prints of his letter from the morning Daily Telegraph. In his 1961 address Mr Pannell stated that though in 1958 Home Secretary R.A.Butler had disagreed with restricting entries he had agreed with his suggestion of deporting immigrants who commit crimes but nothing had been done. Government ministers continued to ignore mass immigration throughout this 58 year period regardless of how innocent British people had to suffer.

Where is the moral high ground in that? In the House of Commons in the mid-50s Marcus Lipton, MP for Brixton (L), said Jamaica was sending their criminals, and was told by the Government minister, They actively discourage it.

He asked How do they? and was fobbed-off, with must get on. Sir J Lucas (C) asked if machinery existed for Jamaica to know how many immigrants had criminal records. Alan Lennox-Boyd (later Lord Boyd) replied, There is not. In Jan 2002 police were worried about muggers progressing to guns. The Independent and The Telegraph reported that crack cocaine was being imported by the Jamaican connection, and was plainly a cause of violence:- Ballistics experts warn that firearms are now cheap and easily available. The discharge of guns in non-gangland crimes, such as muggings, is still relatively rare.

They kept being presented with statistics, but they believed in none of them, and so acted on none. There were 4,658 muggings in the Met area in November 2001 alone, the largest category involving robberies of mobile phones from school children. Overall gun crime in Greater London rose by more 30 per cent last year from around 240 firearms-related incidents in April to 317 in November. The total number of gun murders in April to November 2000 was 16 nearly double the previous year to 30 in the same period last year. Senior Met sources say the age profile of most of the gun criminals arrested in London is between 18 and 30. However, there is deep concern that the level of indiscriminate violence will increase with the next generation.

Detectives in Lambeth and Southwark have spoken of hardened criminals as young as 12. Commenting on this report The Independent tried to deceive their readers by disputing that it was blacks mugging whites, saying that it was only the victims who said the attackers were black! They try to pretend we are not victims of a race war in our own country by emphasising black on black shootings which is gang fights for territory and customers. But the muggings mentioned are blacks attacking whites, especially our elderly who we should be protecting. It is a man's duty to protect the women and children.

Charles Moore, former editor of the Daily Telegraph, produced Salisbury Paper 9 in 1981, The Old People of Lambeth. It was an empirical study of living conditions of whites. One elderly man told him, it's our Queen and our country, why should we be afraid to go out? Even Lord Denning, who is regarded as the greatest judge of the twentieth century was pilloried by the totalitarians. His book What Next In The Law had 10,000 copies withdrawn because of some errors. But he explained:- The English are no longer a homogenous race. They are White and Black, coloured and brown. They no longer share the same standards of conduct. Some of them come from countries where bribery and graft are accepted as an integral part of

life: and where stealing is a virtue so long as you are not found out. Various societies of lawyers attacked him as did The Observer, The Times and Daily Mirror.

A thread comment from Tara, Notting Hill, London on The Evening Standard article of 26 August 2008 about the riots at Notting Hill carnival showed what the reality the elites want to keep hidden is:- I don't know why the media are reporting only 40 bottle throwing rioters, I've just been told by someone who was selling burgers from a burger van in Ladbrooke Grove it was over 500 rioters against about 100 police officers until they got back- up.

On Monday night I was told people were shooting at the police a few streets up ... And more reality from a police officers forum. Ordinary coppers commenting about the media covering up how many arrests there really had been at carnival. One poster claimed there had been:- Nearly 500 arrested and nothing on the BBC news? I find that as unbelievable as I do disgusting. Over time, I can't help but feel that we kid ourselves into thinking that we live in a democracy, but really, we're fed what the Government wants us to be fed and wants us to believe. There is a link to Sky news video and reporter Mark White is praised for being honest. Another poster comments on the latest figures:- re number of Police injuries = 27. Ok not the riot of the century but substantially more than a standoff with police. It irritates me greatly that both the MET and the media seem to want to downplay the seriousness of the event.

Playing down the seriousness of the event is absolutely what the elites want to do. It's propaganda in a time of war.

(1) Salisbury Review. Spring 2003. Vol 21. No3. (<http://www.salisbury-review.co.uk>)

(2) Lord Elton.1965. The Unarmed Invasion.(Geoffrey Bles)



THE CORONAVIRUS WILL COME AND GO.
...BUT THE GOVERNMENT WILL NEVER FORGET HOW EASY IT WAS TO TAKE CONTROL OF YOUR LIFE. TO CONTROL EVERY SPORTING EVENT, CLASSROOM, RESTAURANT TABLE, AND CHURCH PEW. AND EVEN IF YOU ARE ALLOWED TO LEAVE YOUR HOUSE.

Jason Christoff

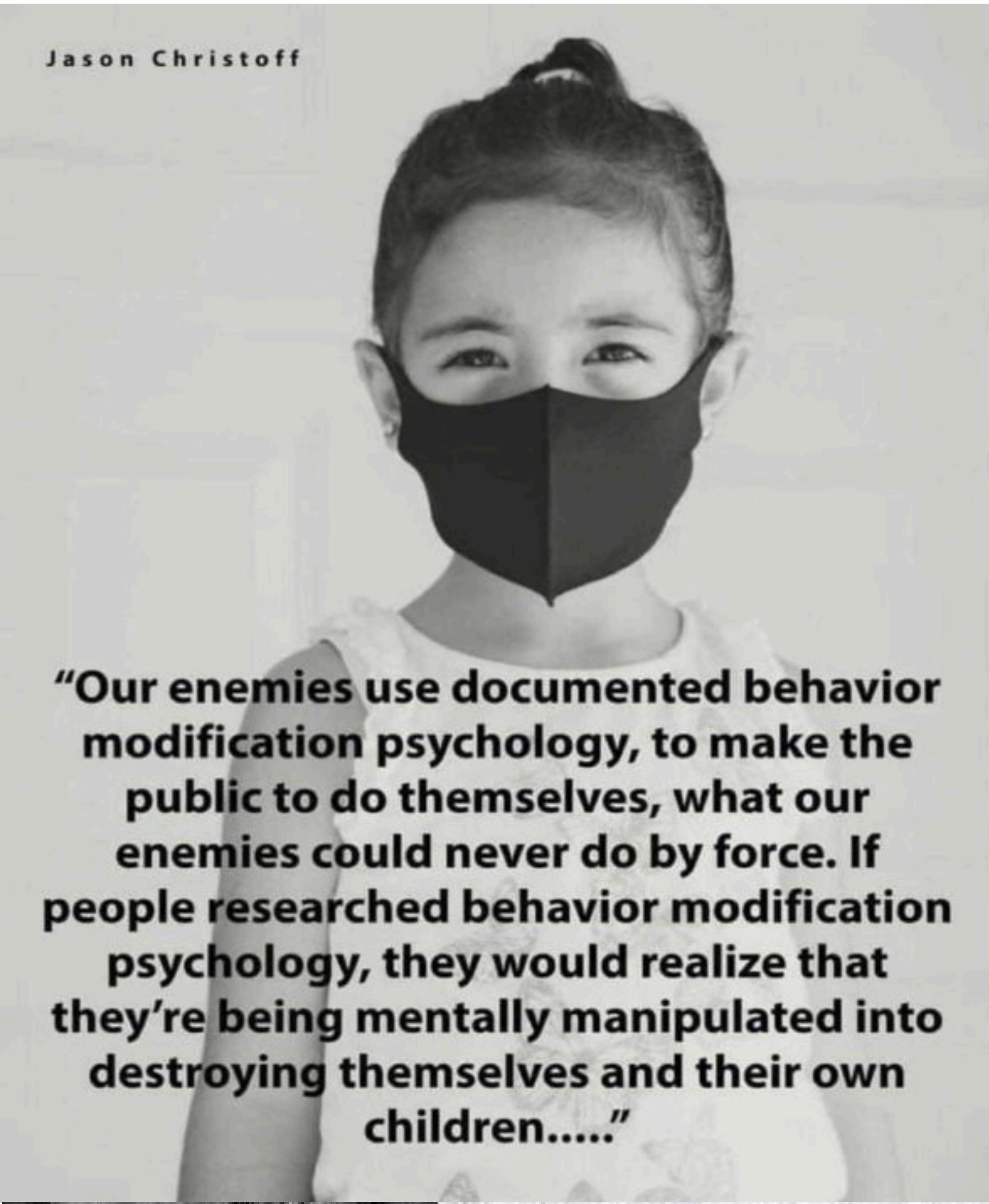

“Our enemies use documented behavior modification psychology, to make the public to do themselves, what our enemies could never do by force. If people researched behavior modification psychology, they would realize that they’re being mentally manipulated into destroying themselves and their own children.....”



“The best way to take control over a people and control them utterly is to take a little of their freedom at a time, to erode rights by a thousand tiny and almost imperceptible reductions. In this way, the people will not see those rights and freedoms being removed until past the point at which these changes cannot be reversed.”

— Adolf Hitler, Mein Kampf



William Wilberforce

On Friday July 26th 1833 as he lay on his deathbed Wilberforce exclaimed: "Thank God that I have lived to witness the day in which England is willing to give £20 million for the abolishment of slavery." (What would that be worth today ?)

He died three days later.

The Slavery Abolition Bill 1833 passed through the House of Lords, it received the Royal Assent (which means it became law) on 29 August 1833 and came into force on 1 August 1834.

On that date slavery was abolished throughout the vast British Empire. The Act automatically applied as new possessions (principally in Africa) subsequently became part of the British Empire.

To know who rules over you. Simply find out who it is that you are not allowed to criticise.Voltaire

We, as White people, have been GAGGED!! Then bullied, insulted, demonised, and provoked, until we object and complain. We then get called *dirty names* like Nazi, Racist, White Extremist, etc, etc.

Our weak & corrupt Lib/Lab/Con Politicians are the problem. As of Jan 2021, the UK elections are years away. Check out Populism, and Nationalism ASAP. Become "WHITE WOKE" & Push Back.

Do it today, NOW!



William Wilberforce

On Friday July 26th 1833 as he lay on his deathbed Wilberforce exclaimed: "Thank God that I have lived to witness the day in which England is willing to give £20 million for the abolishment of slavery." (What would that be worth today ?) He died three days later.

The Slavery Abolition Bill 1833 passed through the House of Lords, it received the Royal Assent (which means it became law) on 29 August 1833 and came into force on 1 August 1834. On that date slavery was abolished throughout the vast British Empire. The Act automatically applied as new possessions (principally in Africa) subsequently became part of the British Empire.

To know who rules over you. Simply find out who it is that you are not allowed to criticise.Voltaire

We, as White people, have been GAGGED!! Then bullied, insulted, demonised, and provoked, until we object and complain. We then get called *dirty names* like Nazi, Racist, White Extremist, etc, etc.

Our weak & corrupt Lib/Lab/Con Politicians are the problem. As of Jan 2021, the UK elections are years away. Check out Populism, and Nationalism ASAP. Become "WHITE WOKE" & Push Back. **Do it today, NOW!**



Race and immigration in the West

Concerned London Patriot - 2004

If there was ever a question of critical importance for the future of western civilization, then it's how it will cope with the effects of major racial demographic change as a result of continued non-European immigration, high reproduction rates in non-European groups, and low birthrates amongst white people.

Virtually all European nations and North America cannot afford to ignore the social and cultural implications of this eventuality. Given that white Europeans constitute less than 15% of the world's population, and that percentage is falling annually, there is a sound basis for patriots to be concerned about their prospects. At the moment the speed of this change is apparent in cities and urbanized areas. Already in London [England], population trends strongly indicate whites will become a minority in the capital by 2010, and a minority in the UK potentially by 2100. Across the Atlantic in the USA, people of European descent are predicted to become a minority by the middle of the century due to similar factors. Nationalist parties across Europe are experiencing surges in popularity in response to public unease about demographic trends and immigration.

Governments have consistently shown indifference that such trends present a serious danger to national stability and social cohesion. Politicians generally fail to acknowledge how race binds a nation together, and that a substantial proportion of their kinsmen mainly wish their nation to retain an indigenous white majority, even if they are not deeply hostile to other ethnic groups or foreigners in limited numbers. Politicians are conscious of the powerful emotive reaction this subject incites in the public arena. They are reluctant to openly advocate their own racial groups interests, lest their careers be jeopardized by accusations of racism from the media or political adversaries.

The late British MP Enoch Powell, an outspoken critic of multiracialism, learnt this lesson to his personal detriment back in the 1960s. Meanwhile contemporary leaders like George W Bush or Tony Blair are unlikely to offer balanced or objective comments on race and immigration.

Even the chronic influx of illegal immigration on Americans southern border with Mexico was avoided in the Bush-Kerry election campaign debates, despite its dire impact on Americans from a variety of ethnic backgrounds. In fact, the only ethnic group George W Bush has pledged unwavering support to have been Jews.

At a May 2004 AIPAC meeting (American Israel Public Affairs Committee) Bush conveyed approval for a Jewish ethnic state in Israel in the following quote "The United States is committed, and I am strongly committed, to the security of Israel as a vibrant Jewish state".

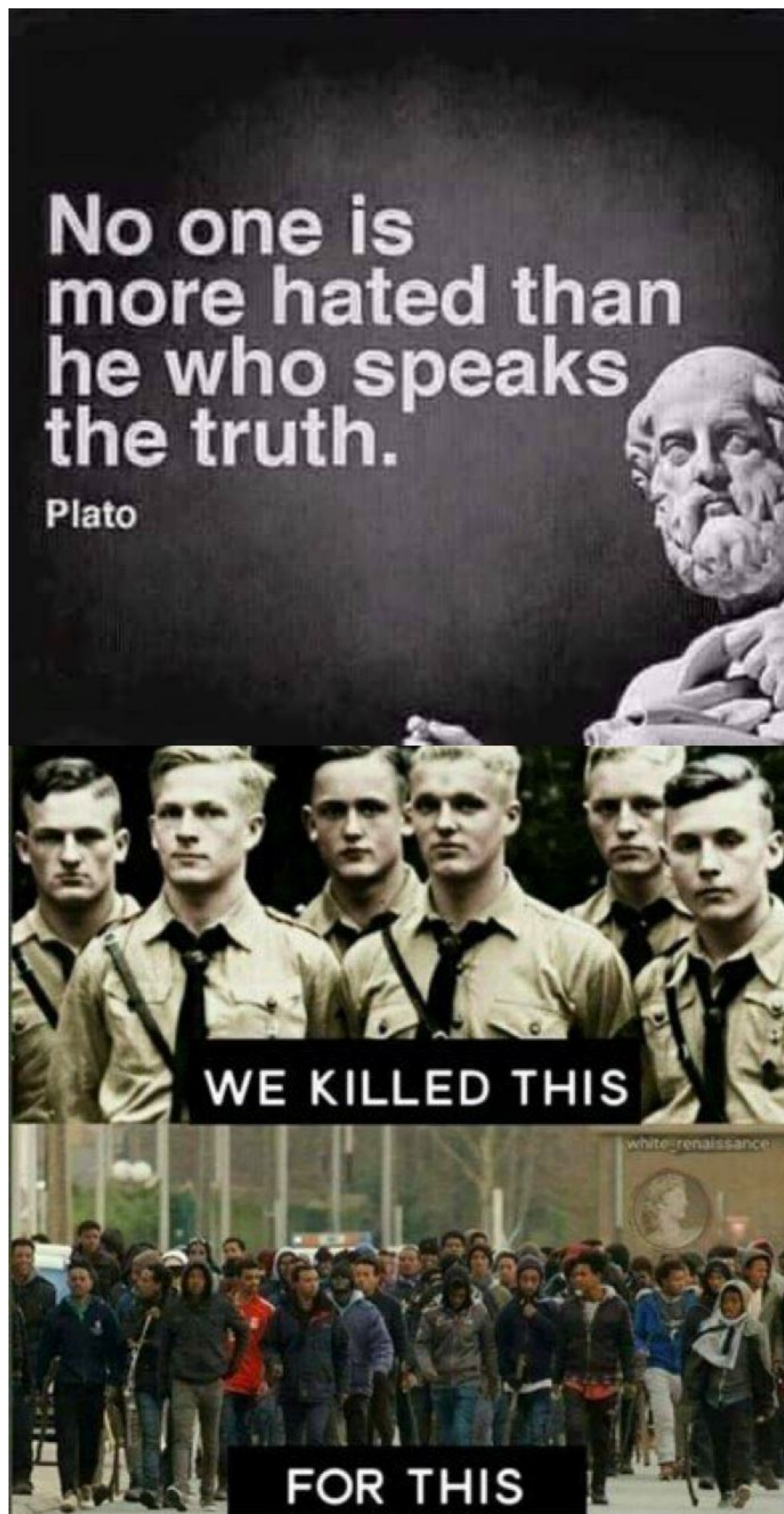

William Wilberforce
On Friday July 26th 1833 as he lay on his deathbed Wilberforce exclaimed: "Thank God that I have lived to witness the day in which England is willing to give £20 million for the abolishment of slavery." (What would that be worth today ?)
He died three days later.

The Slavery Abolition Bill 1833 passed through the House of Lords, it received the Royal Assent (which means it became law) on 29 August 1833 and came into force on 1 August 1834. On that date slavery was abolished throughout the vast British Empire. The Act automatically applied as new possessions (principally in Africa) subsequently became part of the British Empire.

To know who rules over you. Simply find out who it is that you are not allowed to criticise.Voltaire

We, as White people, have been GAGGED!! Then bullied, insulted, demonised, and provoked, until we object and complain. We then get called *dirty names* like Nazi, Racist, White Extremist, etc, etc.

Our weak & corrupt Lib/Lab/Con Politicians are the problem. As of Jan 2021, the UK elections are years away. Check out Populism, and Nationalism ASAP. Become "WHITE WOKE" & Push Back. **Do it today, NOW!**



Recently in October he further signed an Orwellian 'Global Antisemitism Bill', which empowers the State Department to monitor and combat any harsh criticism or attacks on Jews worldwide. Since George W Bush knew little about international affairs when he first entered office in 2000, this strongly biased support to a foreign nation and diasporic group strengthens existing claims that US government policy is influenced by Jews, or neoconservatives as they are often euphemistically referred to.

Well, if Bush does back Israel as an ethnocentric state, then why doesn't he or any other politician in Congress promote the ethnic self-determination of any other nation, including his own?

After all, aren't politicians professed egalitarians these days?

Immigration resistance in Britain

Back in the UK, although race and immigration ranks low on the policy agenda of the main political parties, the British National Party (BNP) stands as the leading political force striving to thwart the looming demographic crisis that awaits white British citizens. Against a backdrop of total legitimacy for the BNPs concerns, an assortment of assailants have exerted pressure to stifle its progress. In late October 2004 the BNPs bank account was closed for the second time round (by HSBC), and the party web site suffered a major denial of service attack from an unknown culprit.

BNP members that have publicly revealed their affiliation have sometimes been threatened with dismissal from their jobs or professional associations.

Media publicity of the BNP is uniformly dismissive, if not slanderous. Ironically, the national newspapers themselves publish articles about asylum seekers or immigrants receiving illicit benefits, or engaged in racketeering, yet denigrate the BNP as extremists for alerting the public about essentially the same problems. In the minds of the journalists who occasionally write these articles, its ok to complain about the problem but somehow immoral to desire to stop it.

It's hardly surprising that the word immigration evokes negative connotations in western countries nowadays. The concept of immigration however is not necessarily historically harmful in itself. Its proponents would point to how the United States was successfully built up by it. A neutral stance against this common argument, is to highlight that the world has now congealed into well defined nation-states with delineated boundaries, and that most countries do not have the capacity for more immigrants without negative repercussions racially, environmentally, and socially. Britain is already a full house. In 1999, net immigration reached 185,000, an all-time record. The Immigration Minister, Barbara Roche at that time announced plans to attract migrants to fill specific skills shortages, such as in the computer industry. [Note: this is pure bs, there is no need to attract migrants to fill computer jobs, as I can personally testify being unable to resume computer work for two years]. Many Americans now believe they have

**We did not lose WW2.
But we have yet to finish
winning it.**

Hitler or Stalin ?

**It's not much of a choice.
Is it ?**

**At all future elections, vote
for one of the 'Populist' or
'Nationalist' parties.**

**Never again vote for any of
the Lib/Lab/Con tricksters.**

**Do you really think that
they've stopped stealing
from us ?**

DREAM ON !!!



William Wilberforce

On Friday July 26th 1833 as he lay on his deathbed Wilberforce exclaimed: "Thank God that I have lived to witness the day in which England is willing to give £20 million for the abolishment of slavery." (What would that be worth today ?) He died three days later.

The Slavery Abolition Bill 1833 passed through the House of Lords, it received the Royal Assent (which means it became law) on 29 August 1833 and came into force on 1 August 1834. On that date slavery was abolished throughout the vast British Empire. The Act automatically applied as new possessions (principally in Africa) subsequently became part of the British Empire.

To know who rules over you. Simply find out who it is that you are not allowed to criticise.Voltaire

We, as White people, have been GAGGED!! Then bullied, insulted, demonised, and provoked, until we object and complain. We then get called *dirty names* like Nazi, Racist, White Extremist, etc, etc.

Our weak & corrupt Lib/Lab/Con Politicians are the problem. As of Jan 2021, the UK elections are years away. Check out Populism, and Nationalism ASAP. Become "WHITE WOKE" & Push Back.

Do it today, NOW!



William Wilberforce

On Friday July 26th 1833 as he lay on his deathbed Wilberforce exclaimed: "Thank God that I have lived to witness the day in which England is willing to give £20 million for the abolishment of slavery." (What would that be worth today ?) He died three days later.

The Slavery Abolition Bill 1833 passed through the House of Lords, it received the Royal Assent (which means it became law) on 29 August 1833 and came into force on 1 August 1834. On that date slavery was abolished throughout the vast British Empire. The Act automatically applied as new possessions (principally in Africa) subsequently became part of the British Empire.

To know who rules over you. Simply find out who it is that you are not allowed to criticise.Voltaire

We, as White people, have been GAGGED!! Then bullied, insulted, demonised, and provoked, until we object and complain. We then get called *dirty names* like Nazi, Racist, White Extremist, etc, etc.

Our weak & corrupt Lib/Lab/Con Politicians are the problem. As of Jan 2021, the UK elections are years away. Check out Populism, and Nationalism ASAP. Become "WHITE WOKE" & Push Back.

Do it today, NOW!

reached full capacity there, and that further immigration at current levels will harm the environment. This couldn't be truer for the UK, which has a severe shortage of affordable housing. Recently the government formulated plans for 500,000 new homes in the east of England to meet the demand. Environmental groups have rejected this proposal, correctly realising that such a scheme will be another step forward in turning Britain into a sprawling concrete concourse.

Demographic change in the USA

Traditional white majority founded nation-states around the world face the same challenge of adjusting to uneven racial population growth rates. The United States for example is usually regarded as being a multi-cultural country, but in fact for nearly two hundred years of its history it was approximately 90% European with a 10% ethnic population consisting mainly of blacks descended from slaves imported from Africa, and a smaller dispersion of Native Americans [Iroquois] that survived the colonization years. The turning point in Americas racial future arose in the civil rights era of the 1960s. The Lyndon B Johnson administration passed the landmark 1965 Immigration Act which abolished immigration eligibility based on national origin. This effectively reduced the number of European immigrants and opened up the gates to the wider world. The advocates of the 1965 bill insisted it wouldn't upset the ethnic balance of the country. A different picture has emerged now. Today the US population has declined to 72% white, and houses a fast growing Hispanic population expected to overtake whites as the largest ethnic group in a few decades. Many patriotic Americans, especially white ones, do not eagerly welcome this prospect. Unlike in France or Britain, there is no mainstream nationalist party in the USA that can garner the votes of white Americans at the polling booths. Maybe Americas long tradition of immigration hasn't compelled dissidents to form a successful political party. Opposition to large scale immigration and anti-white legislation has mainly originated from a variety of campaign groups at state level, and the National Alliance, a pro-white organisation created by the late physics professor Dr William Pierce in the early seventies.

The NA incidentally operates an excellent, accurate daily news service called NationalVanguard.org that covers world affairs with racial implications, and features guest writers articles and reader letters. It is worth noting that both the UK and USA share the same social infrastructure where white race relations are concerned. Both have media institutions biased against whites in their coverage of interracial confrontations, or that refrain from publicizing that whites have legitimate group interests in preserving their racial heritage. Both have governments that do not listen to public opposition to immigration, and both have consumer advertising institutions that promote disproportionate multiracial representation.

The Asylum Issue

Every year thousands of immigrants from poor developing countries attempt to settle permanently in Britain, many under the pretext of political asylum. That is, the process by which individuals may apply for refuge in another country if they

can prove they are being tortured, persecuted, etc due to their politically related beliefs or activities. The right to seek political asylum is outlined in Article 14 of the Universal Declaration of Human Rights drafted by the United Nations in 1948. The United Nations itself was created in 1945, shortly after the end of the Second World War. Britain signed the 1951 United Nations Convention and its 1967 Protocol relating to the Status of Refugees. Later in 1981 the United States enacted a similar law. These treaties recommend that asylum seekers granted legal refugee status should enjoy treatment at least as favorable as that accorded to the indigenous population. The right to seek asylum doesn't guarantee a state is forced to offer asylum to every applicant. Interestingly, the term asylum wasn't used much in colloquial parlance in Britain until as late as the 1990s.

The public became accustomed to this term from media articles on the subject i.e. scandal stories of asylum seekers receiving excessive social security benefits This is surely a clear indication that a large scale asylum problem didn't exist until this time. I would suspect many asylum seekers must have learnt of a right to apply for asylum, even if unaware of its ideological origins in the UN declaration. The asylum system in reality is nothing but an alternative method for foreigners to enter the country by deceitful means. It has been long abused by applicants, the bulk of applications are bogus. The cost of supporting asylum seekers in the English county of Cambridgeshire alone has totalled £8 million over the last six years. All this must be paid for by the tax payer, through increased council tax bills and other forms of government taxation. A system appealing to the idealistic notion of humanitarian compassion has in fact caused misery for numerous communities across the UK that have been inundated with impoverished newcomers. The rapid metamorphosis of these communities have often forced existing longtime residents to seek safer sanctuaries elsewhere. The asylum system may seem fair in principle, but in a world of never ending conflict there will always be a constant exodus of refugees to popular destinations. That alone is the most practical argument against it, along with the cost to the taxpayer and the social unrest it creates.

Causes of world migration

First of all, we must understand why such a large mass migration of people is occurring now in the early 21st century, when in decades past i.e. in the early years of the 20th century the numbers were far less conspicuous. There are further explanations for this besides relaxed immigration controls. Improved transportation and global communications are a clear cause, though discussions on immigration tend to overlook the role it has played. But think for a minute: how did aspiring migrants discover what countries were the best places to move to, aside from recommendations by émigré relatives? The invention of the television in the 20th century and its dissemination throughout the entire world has likely assisted as an educational tool here, allowing a wider audience to see the opportunities available in foreign lands. The aviation revolution should be mentioned too. Following World War II the growth of commercial air travel has drastically reduced migrant journey times, and opened up a wider array of



William Wilberforce

On Friday July 26th 1833 as he lay on his deathbed Wilberforce exclaimed: "Thank God that I have lived to witness the day in which England is willing to give £20 million for the abolishment of slavery." (What would that be worth today ?)

He died three days later.

The Slavery Abolition Bill 1833 passed through the House of Lords, it received the Royal Assent (which means it became law) on 29 August 1833 and came into force on 1 August 1834. On that date slavery was abolished throughout the vast British Empire.

The Act automatically applied as new possessions (principally in Africa) subsequently became part of the British Empire.

To know who rules over you. Simply find out who it is that you are not allowed to criticise.Voltaire

We, as White people, have been GAGGED!! Then bullied, insulted, demonised, and provoked, until we object and complain. We then get called *dirty names* like Nazi, Racist, White Extremist, etc, etc.

Our weak & corrupt Lib/Lab/Con Politicians are the problem. As of Jan 2021, the UK elections are years away. Check out Populism, and Nationalism ASAP. Become "WHITE WOKE" & Push Back.

Do it today, NOW!

destinations. The cost of air travel fell significantly in real terms during the 1990s, enabling poor migrants a chance to afford an air ticket to a better life. Not all migrants pay directly for their tickets however. In extreme cases, prospective migrants overseas hand over their entire life savings to smuggling gangs with dreams of making a fortune in the west. The willingness to pay such high amounts demonstrates that it's not simply the poorest of people who desire to leave their homelands for greener pastures. Desperate immigrants are even prepared to risk a long harrowing journey hidden in road vehicles. In 2002 58 illegal Chinese entrants suffocated to death while hidden in a lorry carrying tomatoes at Dover, England.

This led to the conviction of the Dutch lorry driver and Chinese smugglers who organised the operation. Once immigrants have established communities in host countries, they often encourage relatives to join them, tactfully taking advantage of extended citizenship laws. In the case of Britain, the decline of its empire, and a common British nationality introduced via the 1948 Nationality Act throughout its colonies offered many new citizens a passport by which they could emigrate to the British Isles. Britain was an attractive magnet for Commonwealth immigrants in the post-war economic boom. A substantial portion of the original Afro-Caribbean population in the UK emigrated to England from Jamaica and other parts of the West Indies during the 1960s. Many of them settled in inner London and gained employment with London Transport.

The burgeoning world population has also fuelled migratory urges. As outlined in my essay Consequences of an overpopulated planet the world's population trebled from an estimated 1.6 billion in the early 20th century to a staggering 6 billion by the year 2001. The bulk of this rise was amongst Asiatic peoples in Africa and Asia, partly from medical advances and humanitarian assistance from the West. However, the rise in fertility rates and human longevity hasn't necessarily engendered a great improvement in the quality of life in certain areas there. If that were the case then there wouldn't be such a strong desire to seek a new life in wealthier western countries.

As a population grows unevenly across ethnic groups in shared territory, so does rivalry between them. Africa is still ravaged by conflict between its numerous ethnic groups, providing a constant source of refugees to neighbouring states and destinations further afield. A chronic example was the mass genocide of Rwandans in 1994. Whites too are undergoing genocide in Africa. After the demise of the apartheid era in South Africa in 1994, overall crime has soared, particularly murderous attacks on the shrinking white community. South African patriot Jan Lamprecht has documented a catalogue of disasters that have befallen his country on his African Crisis web site.

From a personal standpoint, I base my opinions on racial trends not only on firmly accepted facts, but also on a history of change I have witnessed in Greater London over the years. Greater London itself has accommodated a mosaic of ethnic groups for several decades now. Most of the Black and Asian population arrived during the fifties and sixties from Commonwealth countries in the post war boom cited earlier.

During my extensive bus excursions as a boy in the 1980s I observed distinct ethnic minority communities distributed across the capital, mainly concentrated in inner London. These communities didn't particularly concern me at the time, as their population levels were still relatively low compared to the white population of London. Furthermore, there was certainly no feeling in the suburbs that white areas were threatened with displacement. I held views on race that would typically be regarded as 'average'.

It wasn't a subject that dominated my thoughts, I understood there were inherent behavioral differences between the races, but I didn't contemplate the significance of these differences because they weren't impacting English society adversely enough at the time. In later years, the question of race and white social cohesion elevated to the forefront of my thoughts as I noticed London's white population steadily dwindle due to uneven birth rates, immigration, miscegenation, and perhaps even white emigration.

Immigration continued steadily during the Conservative government led by 'Iron Lady' Margaret Thatcher from 1979-1990, followed by John Major until 1997. For all practical purposes, the Conservative party were no tougher on immigration than past Labour governments, in contrast to the common misperceptions about them. By the late 1990s the social decay and alienating atmosphere in many parts of London compelled me to acquire a heightened sense of racial consciousness, and made me more sympathetic and curious about white nationalism. Nowadays when I visit London I can't help but feel a grave sense of loss from the place it has become. I see fewer and fewer white English faces aboard the buses, and the ones I do see are tense and withdrawn. I must confess I am sickened by the proliferation of white Anglo-Saxon women that have chosen black partners and sired mixed race children. I can only imagine the majority of these mindless, naive women do not realise they are wrecking a future for white children, who will find themselves a minority in a black and mixed race culture. They cannot grasp the concept that they are playing a decisive role in shaping the future .

Sadly some of these women have no love of white beauty or their own races welfare and integrity. I wouldn't balk at the odd interracial couple, but the extent to which this has spread is hastening the eventual demise of whites in London. The media and advertisers are partly culpable here, as they have frequently published adverts with black men and white women in suggestive positions, and of course have suppressed discussion of rational objections to interracial relationships. I would say roughly since the late 1980s there has been an accelerating campaign by the media to instill white guilt and stultify love of their own race. Typically Hitler and the Nazis have been the primary method of nurturing this shame, as numerous television documentaries over the years attest to.

As a side note, Nazi bashing is a favorite pastime of liberals in general. In the USA, some liberal commentators have even gone as far to denounce their country as 'Nazi America' for the unwarranted invasion of Iraq. This comparison may satisfy feeble minds, but in fact is quite a poor analogy. To begin with, George W Bush didn't invade Iraq for colonization purposes, neither does he have any concern for

white Americans. If he did have any racial ideology, as the National Socialists undoubtedly did, then he certainly wouldn't sanction the ongoing invasion of illegal invaders from Mexico into his country and casually grant many of them amnesty to gain citizenship.

Home grown events in England have been equally effective in nurturing white guilt, even if they don't outwardly display this agenda. Take the case of Stephen Lawrence for example. He was an 18 year old black teenager stabbed to death by white youths at a bus stop in Eltham, South East London in 1993. The media generated an uproar in the country because the killers weren't immediately caught after the incident. The government subsequently commissioned a lengthy report by Lord MacPherson which accused the Metropolitan Police of institutionalised racism for improperly investigating the case and recommended an overhaul of the 'stop and search' policy of ethnic minorities (also known in the USA as racial profiling).

Ten years later the media were still reporting the case

The overall effect of Stephens tragic death was an unfairly demoralized police force, excessive media coverage on every aspect of it, and an inculcation in the publics mind that only non-whites are the targets of race attacks.

Compare this fanfare with 30 year old Scott Anthony Osbourne, who was kicked to death by three blacks outside a supermarket in nearby Lewisham in November 2002. There was no coverage of this shocking murder in the national press or television whatever. The incident was only reported by local newspapers like The News Shopper here, and the ethnicity of the killers withheld where possible. The implication is always the same: whenever whites attack non-whites then it must be racially motivated. When the reverse is true it is just another crime in the eyes of the media and judiciary system. To the average person, racism is a moral stigma that they rarely apply critical thinking to.

White self-hate

A pet gripe of mine is the aggressive and self-hating demeanour of white teenagers in London that have adopted the speech and mannerisms of black youth. I would describe these pitiful hooded white boys as 'Eminem' rebels (the worlds preeminent white rapper) -- products of a dysfunctional society who see no positive white social community to identify with. Thus, as black culture is pervasive in music and fashion now, they naturally try to conform to the predominant culture around them. These boys have little sense of self-respect or white racial responsibility. They exhibit an aspect of a larger problem of what I classify as 'white self-hate'. This phenomenon manifests in various ways across all ages. For years, I haven't been able to work out why so many of my fellow white Anglo-

Stephen Lawrence Rides Again Now in his 28th magnificent year.

Do they really think that we 'White People' don't know what's being done to us, and why ?

In 2021 the Woke Brigade DECLARED
22nd April to be ...

'STEPHEN LAWRENCE DAY'

The death of Stephen Lawrence came about as the result of a drug deal/feud going wrong.

'Race' may or may not have played a part, but it was essentially a drug deal issue.

Black people all over London, and elsewhere, are still being stabbed to death as a result of drugs.

The difference being that these Black people are being stabbed and shot by other Black people.

If anyone should have a National day of remembrance it is 15 year old Kriss Donald from Glasgow.

Or perhaps Lee Rigby, the soldier who was decapitated by Jihadists.

There are many much more deserving cases around. But, they're 'White' victims of Ethnic Violence.

Perhaps Stephen Lawrence is being dug up again, every year now ! Because White people are increasingly rejecting the guilt associated with the Slave Trade.

As the truth becomes more widely known.

On the page below this one, are a couple of videos that will explain much to you.

At all future elections, vote 'Populist' or 'Nationalist'



William Wilberforce

On Friday July 26th 1833 as he lay on his deathbed Wilberforce exclaimed: "Thank God that I have lived to witness the day in which England is willing to give £20 million for the abolishment of slavery." (What would that be worth today ?)

He died three days later.

The Slavery Abolition Bill 1833 passed through the House of Lords, it received the Royal Assent (which means it became law) on 29 August 1833 and came into force on 1 August 1834. On that date slavery was abolished throughout the vast British Empire.

The Act automatically applied as new possessions (principally in Africa) subsequently became part of the British Empire.

To know who rules over you. Simply find out who it is that you are not allowed to criticise.Voltaire

We, as White people, have been GAGGED!! Then bullied, insulted, demonised, and provoked, until we object and complain. We then get called *dirty names* like Nazi, Racist, White Extremist, etc, etc.

Our weak & corrupt Lib/Lab/Con Politicians are the problem. As of Jan 2021, the UK elections are years away. Check out Populism, and Nationalism ASAP. Become "WHITE WOKE" & Push Back.

Do it today, NOW!

Saxons in London, and even in the provinces to a lesser degree, frequently shun each other, and act in a anti-social manner that works against our collective interests. I've lost count of the times I've received a sneering glare from a white person, or found myself ignored by my own kind. This issue of irrational anti-social behaviour is a complete saga in itself that I may divulge in future writing. Anyway, to continue -- the increasingly incidences of intermarriage now apparent between whites and ethnic minorities are a manifestation of this self-hate. Really, if white English people had a deeper love of their own people then they wouldn't be courting non-whites in droves.

The development of these interracial relationships cannot be solely explained as 'individuals' who just happen to get on with each other because their personalities are compatible. If that were true then you'd see Chinese people arm in arm with Blacks, Indians with Blacks, Polish with Nigerians or Jews, etc. Occasionally you might see non-whites of different ethnicities together as friends, but from my careful observations it's very rare. Interracial relationships involving whites inevitably arise because their non-white partners adore the physical beauty, and/or the traits of generosity and compromise that are inherent in our race. For example, most people concede that black men have a preference for white women, just as oriental women are attracted to white men.

A programme I saw on television several years back confirmed this by stating 1 in 3 black men have a white partner.

Some of you may wonder why I am bothered about preserving white society given my diminutive assessment of it; the internal divisions, the masses of consumer oriented lemmings, the lack of idealism, and moronic uncultured yobs that are typical of the housing estate where I now live in the north west. Why don't I just resign myself and let it implode on itself from negligence, self-hate, and irresponsibility? The reason being is that I do have a love of the best elements of my people; the polite, morally upright middle classes in the main who do have self-respect and love of their race. It is this segment of society that I cherish and hope prevails during this time of accelerated demographic change.

Being a patriot I also think we should honour our ancestors struggles to help build the foundations for the quintessential trappings of society we now take for granted.

Having unambiguously expressed my concerns for white society and integrity, please do not infer I abhor all other races, nor have I only sought to learn about white culture. I'm not saying this, by the way, out of an urge to declare an obligatory anti-racist disclaimer. Throughout my life I have regularly sustained cordial acquaintances with individuals of non-European extraction. For example, I usually get on well with Indian and other South Asian peoples, and admire the self-respect they have for their family, race and culture. I also appreciate the respect they have for polite middle class English people. I can also get on with blacks, of West Indian descent usually, and actually studied black culture during the late 1980s when I was a college student, and relatively impartial on racial matters.

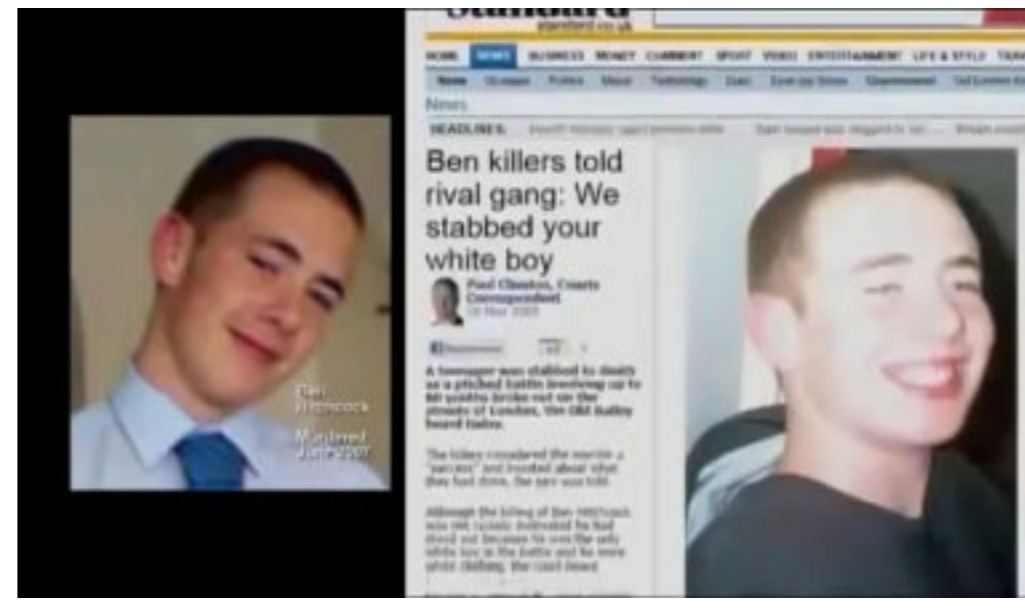

We stabbed your White boy !!

15 Minute video.

Just some of the White victims that you hardly, or never, heard of.

[Open](#)

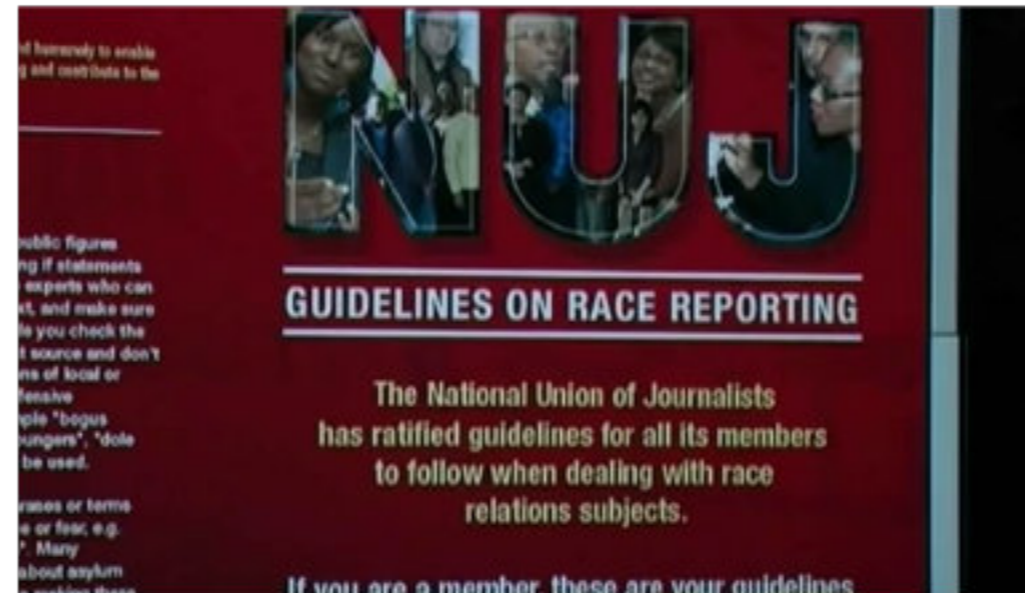

How the NUJ "Dictates" The way their reporters operate when reporting on issues that conflict with the NUJ MARXIST PC agenda. Truth, does NOT matter.

[Open](#)



Stephen Lawrence

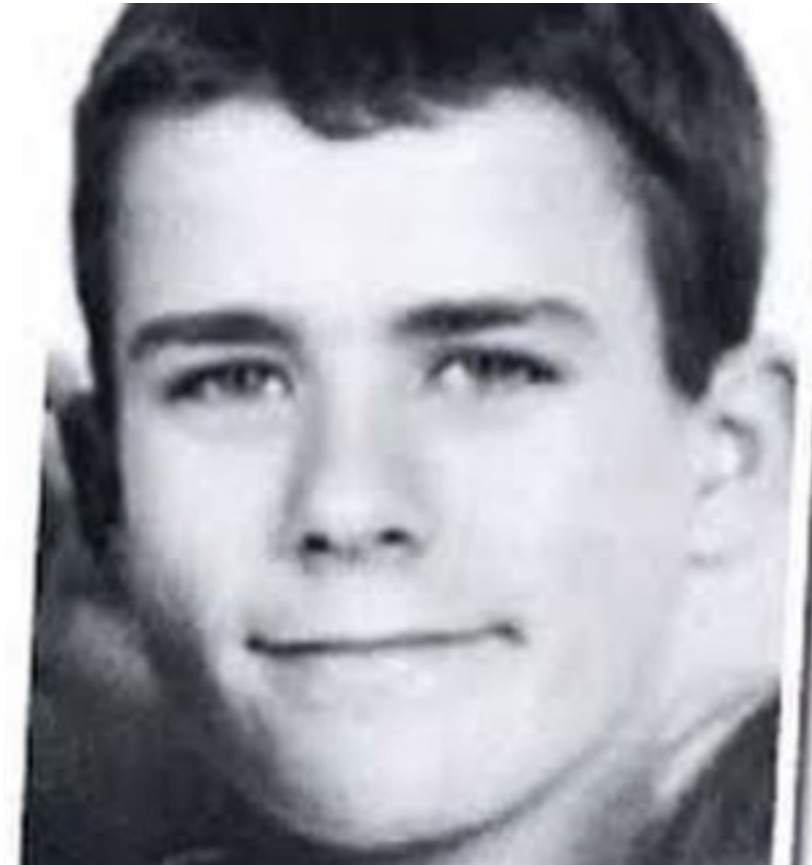

Kriss Donald



Lee Rigby



William Wilberforce
 On Friday July 26th 1833 as he lay on his deathbed Wilberforce exclaimed: "Thank God that I have lived to witness the day in which England is willing to give £20 million for the abolishment of slavery." (What would that be worth today ?)
 He died three days later.

The Slavery Abolition Bill 1833 passed through the House of Lords, it received the Royal Assent (which means it became law) on 29 August 1833 and came into force on 1 August 1834. On that date slavery was abolished throughout the vast British Empire. The Act automatically applied as new possessions (principally in Africa) subsequently became part of the British Empire.

To know who rules over you. Simply find out who it is that you are not allowed to criticise.Voltaire

We, as White people, have been GAGGED!! Then bullied, insulted, demonised, and provoked, until we object and complain. We then get called *dirty names* like Nazi, Racist, White Extremist, etc, etc.

Our weak & corrupt Lib/Lab/Con Politicians are the problem. As of Jan 2021, the UK elections are years away. Check out Populism, and Nationalism ASAP. Become "WHITE WOKE" & Push Back. **Do it today, NOW!**

**William Wilberforce**

On Friday July 26th 1833 as he lay on his deathbed Wilberforce exclaimed: "Thank God that I have lived to witness the day in which England is willing to give £20 million for the abolishment of slavery." (What would that be worth today ?) He died three days later.

The Slavery Abolition Bill 1833 passed through the House of Lords, it received the Royal Assent (which means it became law) on 29 August 1833 and came into force on 1 August 1834. On that date slavery was abolished throughout the vast British Empire. The Act automatically applied as new possessions (principally in Africa) subsequently became part of the British Empire.

To know who rules over you. Simply find out who it is that you are not allowed to criticise.Voltaire

We, as White people, have been GAGGED!! Then bullied, insulted, demonised, and provoked, until we object and complain. We then get called *dirty names* like Nazi, Racist, White Extremist, etc, etc.

Our weak & corrupt Lib/Lab/Con Politicians are the problem. As of Jan 2021, the UK elections are years away. Check out Populism, and Nationalism ASAP. Become "WHITE WOKE" & Push Back.

Do it today, NOW!

They must think of themselves as being part of a group with a destiny instead of rootless individuals with obligations only to their egos. Whites deserve to be exposed to both sides of the coin of the race debate, and not the shallow one that panders to universal sentimentality pushed by the media and government. More often than not, however, whites are intimidated into passivity by the charge of racism, much like Superman is weakened by Kryptonite. I could talk about this subject and its facets until the cows go home; there are volumes of text written on it elsewhere. Ultimately, the most important question for inquisitive responsible minds is what can be done to avert the demise of white society in the UK in the long term, and rest of the west in this predicament .

This is a difficult question that patriots cannot easily answer as well as they can analyse the problem. Most reasonable people desire a strategy that is safe, fair and nice. As the situation continues to deteriorate, as it surely will in coming years, a nice solution will be less attainable. At this stage the most practical measure would be to halt all asylum and immigration, curtail anti-white/anti-Christian propaganda in education, broadcasting, and public bodies (such as the ridiculous decision by the Royal Mail to remove Christian themes from its Christmas 2003 stamp range), and repeal politically correct policies that give unfair concessions to minorities based on race or religion. I'm not a hardcore separatist at heart though. I still approve of an open door for all foreign visitors to travel on holiday, as it would admittedly be mean spirited to bar people from other cultures from discovering and appreciating ours. To recap, the underlying foundation of the alarm about the racial demographic and immigration situation is about preservation, self-respect and order. This is at odds with the liberal doctrine that asserts we should "move with the times", or "come together as one world", and similar superficial excuses. Ultimately we could encourage all resident ethnic groups to pursue their autonomous aspirations, rather than the current modus operandi where whites are discouraged from an exclusive culture, and are goaded into abandoning loyalty to their race and heritage.

The object of any confidence trick, is to create a sense of doubt about the obvious.

Take a look around you at some of our institutions, local authorities and high street chains.

You will find that "Breeding" white females are very thin on the ground, and "Breeding" white males even thinner. Vote populist and do it quick !

The revival of rap music at the time (freed from its former association with breakdancing) by artists like Public Enemy, NWA, and Ice Cube, enticed me to learn more about black culture as a whole. It partly inspired my first holiday to the United States in 1990, when I travelled by Greyhound bus from Detroit to Los Angeles. As you may know, rap music 'crossed over' to the mainstream music scene during the 1990s to become an influential cultural force. The 1990s really was the decade of political correctness in the English speaking world, especially the United States and Britain. In Americas buzzwords like 'affirmative action' (preference to non-white job applicants irrespective of merit) and 'diversity is our strength' entered colloquial speech. In Britain there were similar developments, and racial issues were increasingly discussed in newspaper articles.

A simple analogy I can construct on my racial worldview is similar to that of a father who loves his family. He may actually like, or even love his neighbors down the road, but he carries that extra special devotion to his biological relatives.

Naturally I too have that extra bit of predisposition to my ethnic family, their heritage, and group interests.

Now that my 'family' is in serious jeopardy, partly through their own negligence, I cannot refrain from expressing this concern, and putting their welfare first.

I have been intrigued with scholarly academic research on group traits particular to white northern Europeans, and have read various authors findings.

Kevin MacDonald, a California State University professor who has written a trilogy of books on Judaism, has suggested that white peoples tendency towards individualism, low birth rates, monogamy, and a lack of extended kinship outside of the immediate family may have originated from their common roots in a harsh, low resource environment. It was the demanding nature of this environment that required these behavioural traits to develop as a survival strategy. Indeed, there is some evidence to indicate that 80% of European genes share a common ancestry in northern Europe 30,000 - 40,000 years ago, which includes the period of the last ice age. MacDonald also goes on to say that individualistic societies (like those of Europeans) are not instinctively inclined to erect defences against outsiders, unlike the collectivist social structures in the Middle East and other parts of the Asiatic world. What this means in other words is that whites are not unified enough to recognise external threats to their future well being, and they let their sense of fair play work against them, practicing a kind of moral altruism.

The future

To survive and prosper in the times ahead, whites need to break free from their evolutionary shackles that predisposes them to behaviour ill suited to a competitive multiracial environment. Firstly, white society at large must grow out of its childish interpretation of racism and learn that it's not unreasonable of us to make distinctions between ethnic groups in order to secure a stable future for white children, all the while maintaining respectful relations with the rest of humanity.

The Historical Roots of Political Correctness

By Raymond V. Raehn

<https://davidduke.com/how-a-handfull-of-marxist-jews-turned-western-and-us-culture-upside-down/>



The founders of the Frankfurt School of Cultural Marxism were all Jews. Just like their 'Spiritual Leader' Karl Marx.

America is today dominated by an alien system of beliefs, attitudes and values that we have come to know as "Political Correctness." Political Correctness seeks to impose a uniformity of thought and behavior on all Americans and is therefore totalitarian in nature. Its roots lie in a version of Marxism which seeks a radical inversion of the traditional culture in order to create a social revolution.

Social revolution has a long history, conceivably going as far back as Plato's Republic. But it was the French Revolution of 1789 that inspired Karl Marx to develop his theories in the nineteenth century. In the twentieth century, the success of the Bolshevik Revolution of 1917 in Russia set off a wave of optimistic expectation among the Marxist forces in Europe and America that the new proletarian world of equality was finally coming into being. Russia, as the first communist nation in the world, would lead the revolutionary forces to victory.

MARXISM - Read how this ideology was invented, created, developed, call it what you will. For the EXPLICIT PURPOSE of undermining western man, his civilisation and his culture. And ultimately destroying Western (White) people.

Years later, to resist this MARXIST "White Genocide" National Socialism, or Nazi/Nazism was born. Looking at immigration, diversity, and multi-culti in the UK in 2021. It's obvious that this "White Genocide" is still in full swing. And has been since the end of WW2.



Leftist Jews in America, behind immigration into Europe, of people who want to kill us. Do not speak of it or complain, you will be prosecuted for "Anti Semitism".

[Open](#)

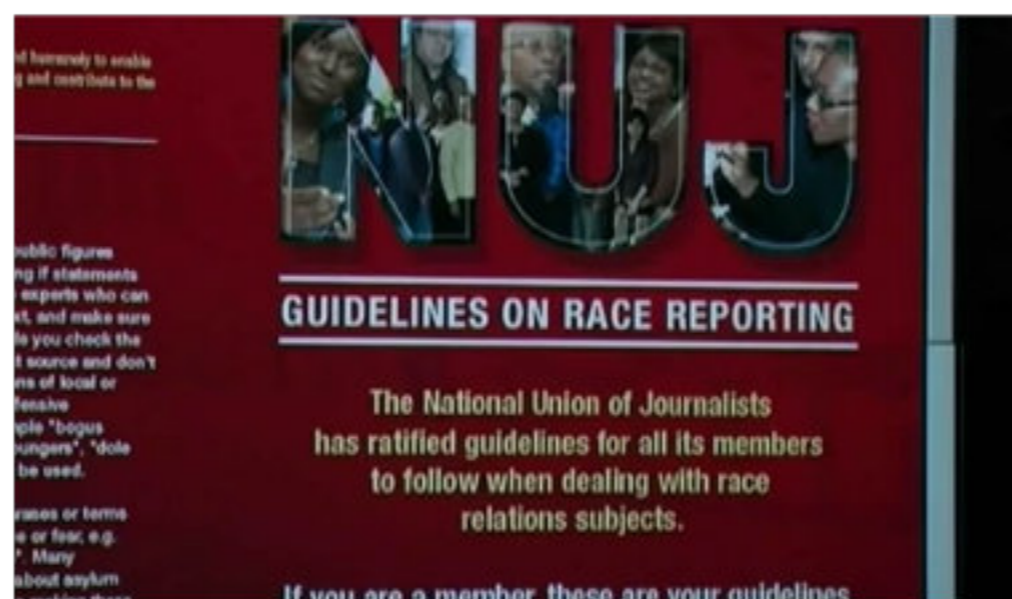

How the NUJ "Dictates" The way their reporters operate when reporting on issues that conflict with the NUJ MARXIST PC agenda. Truth, does NOT matter.

[Open](#)

Professor Kai Murros

England Is At WAR



Professor Kai Murros
[England Is At WAR](#)

"The low intensity ethnic warfare your elites have waged against you for decades, has now reached new levels"

[Open](#)

[More Educational Videos](#)



William Wilberforce

On Friday July 26th 1833 as he lay on his deathbed Wilberforce exclaimed: "Thank God that I have lived to witness the day in which England is willing to give £20 million for the abolishment of slavery." (What would that be worth today ?) He died three days later.

The Slavery Abolition Bill 1833 passed through the House of Lords, it received the Royal Assent (which means it became law) on 29 August 1833 and came into force on 1 August 1834. On that date slavery was abolished throughout the vast British Empire. The Act automatically applied as new possessions (principally in Africa) subsequently became part of the British Empire.

To know who rules over you. Simply find out who it is that you are not allowed to criticise.Voltaire

We, as White people, have been GAGGED!! Then bullied, insulted, demonised, and provoked, until we object and complain. We then get called *dirty names* like Nazi, Racist, White Extremist, etc, etc.

Our weak & corrupt Lib/Lab/Con Politicians are the problem. As of Jan 2021, the UK elections are years away. Check out Populism, and Nationalism ASAP. Become "WHITE WOKE" & Push Back.

Do it today, NOW!

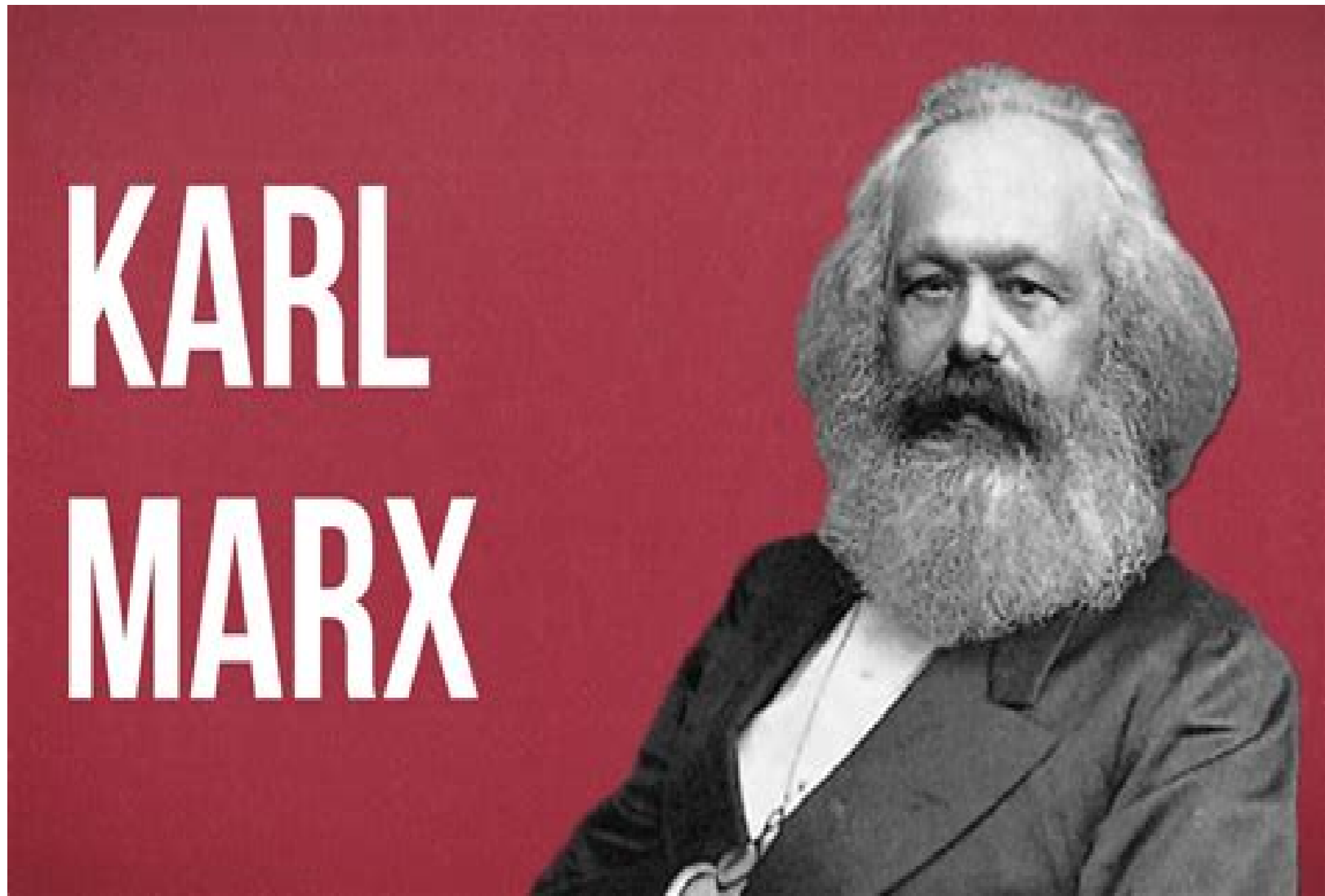

workers were supposed to be the beneficiaries of a social revolution that would place them on top of the power structure. When these revolutionary opportunities presented themselves, however, the workers did not respond. **The Marxist revolutionaries did not blame their theory for these failures. They blamed the workers.**

One group of Marxist intellectuals resolved their quandary by an analysis that focused on society's cultural "superstructure" rather than on the economic substructures as Marx did. The Italian Marxist Antonio Gramsci and Hungarian



Marxist Georg Lukacs contributed the most to this new cultural Marxism.

Bella Kun

Antonio Gramsci worked for the Communist International during 1923-24 in Moscow and Vienna. He was later imprisoned in one of Mussolini's jails where he wrote his famous "Prison Notebooks."

Among Marxists, Gramsci is noted for his theory of cultural hegemony as the means to class dominance. In his view, a new "Communist man" had to be created before any political revolution was possible. This led to a focus on the efforts of intellectuals in the fields of education and culture. Gramsci envisioned a long march through the society's institutions, including the government, the judiciary, the military, the schools and the media. He also concluded that so long as the workers had a Christian soul, they would not respond to revolutionary appeals.

Georg Lukacs was the son a wealthy Hungarian banker. Lukacs began his political life as an agent of the Communist International.



The Blood Drenched Red Army Commander, Leon Trotsky..

Real name Leo Bronstein. He changed his name to hide the fact that he was Jewish.

His book History and Class Consciousness gained him recognition as the leading Marxist theorist since Karl Marx.

Lukacs believed that for a

new Marxist culture to emerge, the existing culture must be destroyed. He said, "I saw the revolutionary destruction of society as the one and only solution to the cultural contradictions of the epoch," and, "Such a worldwide overturning of values cannot take place without the annihilation of the old values and the creation of new ones by the revolutionaries."



The Marxist revolutionary forces in Europe leaped at this opportunity. Following the end of World War I, there was a Communist "Spartacist uprising in Berlin, Germany lead by Rosa Luxemburg; the creation of a "Soviet" in Bavaria led by Kurt Eisner; and a Hungarian communist republic established by Bela Kun in 1919.

Rosa Luxemburg

At the time, there was great concern that all of Europe might fall under the banner of Bolshevism. This sense of impending doom was given vivid life by Trotsky's Red Army invasion of Poland in 1919.



Kurt Eisner

However, the Red Army was defeated by Polish forces at the battle of the Vistula in 1920. The Spartacist, Bavarian Soviet and Bela Kun governments all failed to gain widespread support from the workers and after a brief time they were all overthrown. These events created a quandary for the Marxist revolutionaries in Europe. Under Marxist economic theory, the oppressed



William Wilberforce

On Friday July 26th 1833 as he lay on his deathbed Wilberforce exclaimed: "Thank God that I have lived to witness the day in which England is willing to give £20 million for the abolishment of slavery." (What would that be worth today ?) He died three days later.

The Slavery Abolition Bill 1833 passed through the House of Lords, it received the Royal Assent (which means it became law) on 29 August 1833 and came into force on 1 August 1834. On that date slavery was abolished throughout the vast British Empire. The Act automatically applied as new possessions (principally in Africa) subsequently became part of the British Empire.

To know who rules over you. Simply find out who it is that you are not allowed to criticise.Voltaire

We, as White people, have been GAGGED!! Then bullied, insulted, demonised, and provoked, until we object and complain. We then get called *dirty names* like Nazi, Racist, White Extremist, etc, etc.

Our weak & corrupt Lib/Lab/Con Politicians are the problem. As of Jan 2021, the UK elections are years away. Check out Populism, and Nationalism ASAP. Become "WHITE WOKE" & Push Back.

Do it today, NOW!



William Wilberforce

On Friday July 26th 1833 as he lay on his deathbed Wilberforce exclaimed: "Thank God that I have lived to witness the day in which England is willing to give £20 million for the abolishment of slavery." (What would that be worth today ?) He died three days later.

The Slavery Abolition Bill 1833 passed through the House of Lords, it received the Royal Assent (which means it became law) on 29 August 1833 and came into force on 1 August 1834. On that date slavery was abolished throughout the vast British Empire. The Act automatically applied as new possessions (principally in Africa) subsequently became part of the British Empire.

To know who rules over you. Simply find out who it is that you are not allowed to criticise.Voltaire

We, as White people, have been GAGGED!! Then bullied, insulted, demonised, and provoked, until we object and complain. We then get called *dirty names* like Nazi, Racist, White Extremist, etc, etc.

Our weak & corrupt Lib/Lab/Con Politicians are the problem. As of Jan 2021, the UK elections are years away. Check out Populism, and Nationalism ASAP. Become "WHITE WOKE" & Push Back. **Do it today, NOW!**

Tough talking FRAUDS of British Radio.

The best way to control the opposition, is to lead it ourselves.
..... 'Lenin'

Open



Instruction to all USA communists in 1943. When certain obstructionists become too irritating, label them after suitable build up, as Fascists, or Nazi, or Anti Semitic.

Open



G Edward Griffin's warned us in 1969. It worked in 1943 and it's working today.

This is what happens to us white people, if we show signs of getting uppity. "Leaving the psychological 'Guilt' plantation"

The Soviet Story. Hang at least 100 kulaks, execute the hostages. Do it in such a way that people for hundreds of miles around will see and tremble.Lenin

Open



Adolf Hitler The Greatest Story Never Told

Video 6.5 hours long. MP4 file. This is a large document of 1.5 GB Best option is to download and view offline.

This video contains lots of Jaw Dropping information that we never get told, or that has been blatantly lied about. Note the truth about Black Olympic Athlete Jesse Owens !

Open



Adolf Hitler as a young art student. (Video frame)

This whole period is well overdue for re-examination. No other period in History has been so censored and lied about. **Why?**

More Educational Videos

When he became Deputy Commissar for Culture in the Bolshevik Bela Kun regime in Hungary in 1919, Lukacs launched what became known as "Cultural Terrorism." As part of this terrorism he instituted a radical sex education program in Hungarian schools. Hungarian children were instructed in free love, sexual intercourse, the archaic nature of middle-class family codes, the out-datedness of monogamy, and the irrelevance of religion, which deprives man of all pleasures. Women, too, were called to rebel against the sexual mores of the time. Lukacs's campaign of "Cultural Terrorism" was a precursor to what Political Correctness would later bring to American schools.

In 1923, Lukacs and other Marxist intellectuals associated with the Communist Party of Germany founded the Institute of Social Research at Frankfurt University in Frankfurt, Germany. The Institute, which became known as the Frankfurt School, was modeled after the Marx-Engels Institute in Moscow.

In 1933, when Nazis came to power in Germany, the members of the Frankfurt School fled. Most came to the United States.

The members of the Frankfurt School conducted numerous studies on the beliefs, attitudes and values they believed lay behind the rise of National Socialism in Germany. The Frankfurt School's studies combined Marxist analysis with Freudian psychoanalysis to form the basis of what became known as "Critical Theory."

Critical Theory was essentially destructive criticism of the main elements of Western culture, including Christianity, capitalism, authority, the family, patriarchy, hierarchy, morality, tradition, sexual restraint, loyalty, patriotism, nationalism, heredity, ethnocentrism, convention and conservatism. These criticisms were reflected in such works of the Frankfurt School as Erich Fromm's Escape from Freedom and The Dogma of Christ, Wilhelm's Reich's The Mass Psychology of Fascism and Theodor Adorno's

The Authoritarian Personality.

The Authoritarian Personality, published in 1950, substantially influenced American psychologists and social scientists. The book was premised on one basic idea, that the presence in a society of Christianity, capitalism and the patriarchal-authoritarian family created a character prone to racial prejudice and German fascism. The Authoritarian Personality became a handbook for a national campaign against any kind of prejudice or discrimination on the theory that if these evils were not eradicated, another Holocaust might occur on the American continent. This campaign, in turn, provided a basis for Political Correctness.

Critical Theory incorporated sub-theories which themselves were intended to chip away at specific elements of the existing culture, including "matriarchal theory," "androgyny theory," "personality theory," "authority theory," "family theory,"



William Wilberforce

On Friday July 26th 1833 as he lay on his deathbed Wilberforce exclaimed: "Thank God that I have lived to witness the day in which England is willing to give £20 million for the abolishment of slavery." (What would that be worth today ?) He died three days later.

The Slavery Abolition Bill 1833 passed through the House of Lords, it received the Royal Assent (which means it became law) on 29 August 1833 and came into force on 1 August 1834. On that date slavery was abolished throughout the vast British Empire. The Act automatically applied as new possessions (principally in Africa) subsequently became part of the British Empire.

To know who rules over you. Simply find out who it is that you are not allowed to criticise.Voltaire

We, as White people, have been GAGGED!! Then bullied, insulted, demonised, and provoked, until we object and complain. We then get called *dirty names* like Nazi, Racist, White Extremist, etc, etc.

Our weak & corrupt Lib/Lab/Con Politicians are the problem. As of Jan 2021, the UK elections are years away. Check out Populism, and Nationalism ASAP. Become "WHITE WOKE" & Push Back.

Do it today, NOW!

Frankfurt School, but she was strongly influenced by it. Her work offers a useful case study of the Marxist roots of Political Correctness.

Friedan devoted almost a full chapter of *The Feminine Mystique* to Abraham Maslow's theory of self-actualization. Maslow was a social psychologist who in his early years did research on female dominance and sexuality. Maslow was a friend of Herbert Marcuse at Brandeis University and had met Erich Fromm in 1936. He was strongly impressed by Fromm's Frankfurt School ideology. He wrote an article, "The Authoritarian Character Structure," published in 1944, that reflected the personality theory of Critical Theory. Maslow was also impressed with the work of Wilhelm Reich, who was another Frankfurt School originator of personality theory.

The significance of the historical roots of Political Correctness cannot be fully appreciated unless Betty Friedan's revolution in sex roles is viewed for what it really was – a manifestation of the social revolutionary process begun by Karl Marx. Friedan's reliance on Abraham Maslow's reflection of Frankfurt School ideology is simply one indicator. Other indicators include the correspondence of Friedan's revolution in sex roles with Georg Lukacs' annihilation of old values and the creation of new ones, and with Herbert Marcuse's transvaluation of values. But the idea of transforming a patriarchy into a matriarchy – which is what a sex-role inversion is designed to do – can be connected directly to Friedrich Engels book *The Origin of the Family, Private Property, and the State*.

First published in 1884, this book popularized the now-accepted feminist belief that deep-rooted discrimination against the oppressed female sex was a function of patriarchy. The belief that matriarchy was the solution to patriarchy flows from Marx's comments in *The German Ideology*, published in 1845. In this work Marx advanced the idea that wives and children were the first property of the patriarchal male. The Frankfurt School's matriarchal theory (and its near-relation, androgyny theory) both originated from these sources.

When addressing the general public, advocates of Political Correctness – or cultural Marxism, to give it its true name – present their beliefs attractively. It's all just a matter of being "sensitive" to other people, they say. They use words such as "tolerance" and "diversity," asking, "Why can't we all just get along?"

The reality is different. Political Correctness is not at all about "being nice," unless one thinks gulags are nice places. Political Correctness is Marxism, with all that implies: loss of freedom of expression, thought control, inversion of the traditional social order and, ultimately, a totalitarian state. If anything, the cultural Marxism created by the Frankfurt School is more horrifying than the old, economic Marxism that ruined Russia. At least the economic Marxists did not exalt sexual perversion and attempt to create a matriarchy, as the Frankfurt School and its descendants have done.

This short essay has sought to show one critical linkage, that between classical Marxism and the ingredients of the "cultural revolution" that broke out in America in the 1960s. The appendices to this paper offer a "wiring diagram" which may

"sexuality theory," "racial theory," "legal theory" and "literary theory." Put into practice, these theories were to be used to overthrow the prevailing social order and usher in social revolution based on cultural Marxism.

To achieve this, the Critical Theorists of the Frankfurt School recognized that traditional beliefs and the existing social structure would have to be destroyed and then replaced. The patriarchal social structure would be replaced with matriarchy; the belief that men and women are different and properly have different roles would be replaced with androgyny; and the belief that heterosexuality is normal would be replaced with the belief that homosexuality is "normal." As a grand scheme intended to deny the intrinsic worth of white, heterosexual males, the Critical Theorists of the Frankfurt School opened the door to the racial and sexual antagonisms of the Trotskyites. **Leon Trotsky believed that oppressed blacks could be the vanguard of a communist revolution in North America. He denounced white workers who were prejudiced against blacks and instructed them to unite with the blacks in revolution. Trotsky's ideas were adopted by many of the student leaders of the 1960s counterculture movement, who attempted to elevate the black revolutionaries to positions of leadership in their movements**

The student revolutionaries were also strongly influenced by the ideas of Herbert Marcuse, another member of the Frankfurt School. Marcuse preached the "Great Refusal," a rejection of all basic Western concepts, sexual liberation and the merits of feminist and black revolutions. His primary thesis was that university students, ghetto blacks, the alienated, the asocial, and the Third World could take the place of the proletariat in the Communist revolution.

In his book, *An Essay on Liberation*, Marcuse proclaimed his goals of a radical transvaluation of values; the relaxation of taboos, cultural subversion; Critical Theory; and a linguistic rebellion that would amount to a methodical reversal of meaning. As for racial conflict, Marcuse wrote that white men are guilty and that blacks are the most natural force of rebellion.

Marcuse may be the most important member of the Frankfurt School in terms of the origins of Political Correctness, because he was the critical link to the counterculture of the 1960s. His objective was clear: "One can rightfully speak of a cultural revolution, since the protest is directed toward the whole cultural establishment, including morality of existing society..." His means was liberating the powerful, primeval force of sex from its civilized restraints, a message preached in his book, *Eros and Civilization*, published in 1955. Marcuse became one of the main gurus of the 1960s adolescent sexual rebellion; he himself coined the expression, "make love, not war." With that role, the chain of Marxist influence via the Frankfurt School was completed: from Lukacs's service as Deputy Commissar for Culture in the Bolshevik Hungarian government in 1919 to American students burning the flag and taking over college administration buildings in the 1960s. Today, many of these same colleges are bastions of Political Correctness, and the former student radicals have become the faculties.

One of the most important contributors to Political Correctness was Betty Friedan. Through her book *The Feminine Mystique*, Friedan became the mother of the modern feminist movement in America. Friedan was not a member of the

make the trail easier to follow, along with a more detailed look at some of the main actors. Of course, the action does not stop in the '60s; the workings of Frankfurt School are yet very much with us, especially in the field of education. That topic, and other present-day effects of Frankfurt School thinking, will be the subjects of future chapters in this book.

Profiles



Georg Lukacs

- He began his political life as a Kremlin agent of the Communist International.
- His *History and Class-Consciousness* gained him recognition as the leading Marxist theorist since Karl Marx.
- In 1919 he became the Deputy Commissar for Culture in the Bolshevik Bela Kun Regime in Hungary. He instigated what became known as the "Cultural Terrorism."
- The Cultural Terrorism was a precursor of what was to happen in American schools.
- He launched an "explosive" sex education program. Special lectures were organized in Hungarian schools and literature was printed and distributed to instruct children about free love, the nature of sexual intercourse, the archaic nature of the bourgeois family codes, the outdatedness of monogamy and the irrelevance of religion, which deprives man of all pleasure. Children urged thus to reject and deride paternal authority and the authority of the Church, and to ignore precepts of morality, were easily and spontaneously turned into delinquents with whom only the police could cope. This call to rebellion addressed to Hungarian children was matched by a call to rebellion addressed to Hungarian women.
- In rejecting the idea that Bolshevism spelled the destruction of civilization and culture, Lukacs stated: "Such a worldwide overturning of values cannot take place without the annihilation of the old values and the creation of new ones by the revolutionaries."
- Lukacs' state of mind was expressed in his own words:

o "All the social forces I had hated since my youth, and which I aimed in spirit to annihilate, now came together to unleash the First Global War."

o "I saw the revolutionary destruction of society as the one and only solution to the cultural contradictions of the epoch."

o "The question is, Who will free us from the yoke of Western Civilization?"

o "Any political movement capable of bringing Bolshevism to the West would have to be 'Demonic.'"

o "The abandonment of the soul's uniqueness solves the problem of 'unleashing' the diabolic forces lurking in all the violence which are needed to create a revolution."

- Lukacs' state of mind was typical of those who represented the forces of Revolutionary Marxism.

- At a secret meeting in Germany in 1923, Lukacs proposed the concept of inducing "Cultural Pessimism" in order to increase the state of hopelessness and alienation in the people of the West as a necessary prerequisite for revolution.

- This meeting led to the founding of the Institute for Social Research at Frankfurt University in Germany in 1923 – an organization of Marxist and Communist-oriented psychologists, sociologists and other intellectuals that came to be known as the Frankfurt School, which devoted itself to implementing Georg Lukacs's program.



Antonio Gramsci

- He was an Italian Marxist on an intellectual par with Georg Lukacs who arrived by analysis at the same conclusions as Lukacs and the Frankfurt School regarding the critical importance of intellectuals in fomenting revolution in the West.

- He had traveled to the Soviet Union after the Bolshevik Revolution of 1917 and made some accurate observations that caused him to conclude that a Bolshevik-style uprising could not be brought about by Western workers due to the nature of their Christian souls.



William Wilberforce

On Friday July 26th 1833 as he lay on his deathbed Wilberforce exclaimed: "Thank God that I have lived to witness the day in which England is willing to give £20 million for the abolishment of slavery." (What would that be worth today?) He died three days later.

The Slavery Abolition Bill 1833 passed through the House of Lords, it received the Royal Assent (which means it became law) on 29 August 1833 and came into force on 1 August 1834. On that date slavery was abolished throughout the vast British Empire. The Act automatically applied as new possessions (principally in Africa) subsequently became part of the British Empire.

To know who rules over you. Simply find out who it is that you are not allowed to criticise.Voltaire

We, as White people, have been GAGGED!! Then bullied, insulted, demonised, and provoked, until we object and complain. We then get called *dirty names* like Nazi, Racist, White Extremist, etc, etc.

Our weak & corrupt Lib/Lab/Con Politicians are the problem. As of Jan 2021, the UK elections are years away. Check out Populism, and Nationalism ASAP. Become "WHITE WOKE" & Push Back.

Do it today, NOW!



William Wilberforce

On Friday July 26th 1833 as he lay on his deathbed Wilberforce exclaimed: "Thank God that I have lived to witness the day in which England is willing to give £20 million for the abolishment of slavery." (What would that be worth today ?) He died three days later.

The Slavery Abolition Bill 1833 passed through the House of Lords, it received the Royal Assent (which means it became law) on 29 August 1833 and came into force on 1 August 1834. On that date slavery was abolished throughout the vast British Empire. The Act automatically applied as new possessions (principally in Africa) subsequently became part of the British Empire.

To know who rules over you. Simply find out who it is that you are not allowed to criticise.Voltaire

We, as White people, have been GAGGED!! Then bullied, insulted, demonised, and provoked, until we object and complain. We then get called *dirty names* like Nazi, Racist, White Extremist, etc, etc.

Our weak & corrupt Lib/Lab/Con Politicians are the problem. As of Jan 2021, the UK elections are years away. Check out Populism, and Nationalism ASAP. Become "WHITE WOKE" & Push Back.

Do it today, NOW!

- Antonio Gramsci became the leader of the Italian Communist Party, which earned him a place in one of Mussolini’s jails in the 1930s, where he wrote Prison Notebooks and other documents.

- These works became available in English to Americans.

- His advice to the intellectuals was to begin a long march through the educational and cultural institutions of the nation in order to create a new Soviet man before there could be a successful political revolution.

- This reflected his observations in the Soviet Union that its leaders could not create such a new Soviet man after the Bolshevik Revolution.

- This blueprint for mind and character change made Gramsci a hero of Revolutionary Marxism in American education and paved the way for creation of the New American Child in the schools by the education cartel.

- The essential nature of Antonio Gramsci’s revolutionary strategy is reflected in Charles A. Reich’s The Greening of America: “There is a revolution coming. It will not be like revolutions in the past. It will originate with the individual and the culture, and it will change the political structure as its final act. It will not require violence to succeed, and it cannot be successfully resisted by violence. This is revolution of the New Generation.”



Wilhelm Reich

- In his 1933 book entitled The Mass Psychology of Fascism, he explained that the Frankfurt School departed from the Marxist sociology that set “Bourgeois” against “Proletariat.” Instead, the battle would be between “reactionary” and “revolutionary” characters.

- He also wrote a book entitled The Sexual Revolution, which was a precursor of what was to come in the 1960s.

- His “sex-economic” sociology was an effort to harmonize Freud’s psychology with Marx’s economic theory.

- Reich’s theory was expressed in his words: “The authoritarian family is the authoritarian state in miniature. Man’s authoritarian character structure is basically produced by the embedding of sexual inhibitions and fear in the living substance of sexual impulses. Familial imperialism is ideologically reproduced in national imperialism...the authoritarian family...is a factor where reactionary ideology and reactionary structures are produced.”

- Wilhelm Reich’s theory, when coupled with Georg Lukacs’ sex education in Hungary, can be seen as the source for the American education cartel’s insistence on sex education from kindergarten onwards and its complete negation of the paternal family, external authority, and the traditional character structure.

- Reich’s theory encompassed other assertions that seem to have permeated American education:

- o The organized religious mysticism of Christianity was an element of the authoritarian family that led to Fascism.

- o The patriarchal power in and outside of man was to be dethroned.

- o Revolutionary sexual politics would mean the complete collapse of authoritarian ideology.

- o Birth control was revolutionary ideology.

- o Man was fundamentally a sexual animal.

- Reich’s The Mass Psychology of Fascism was in its ninth printing as of 1991, and is available in most college bookstores.

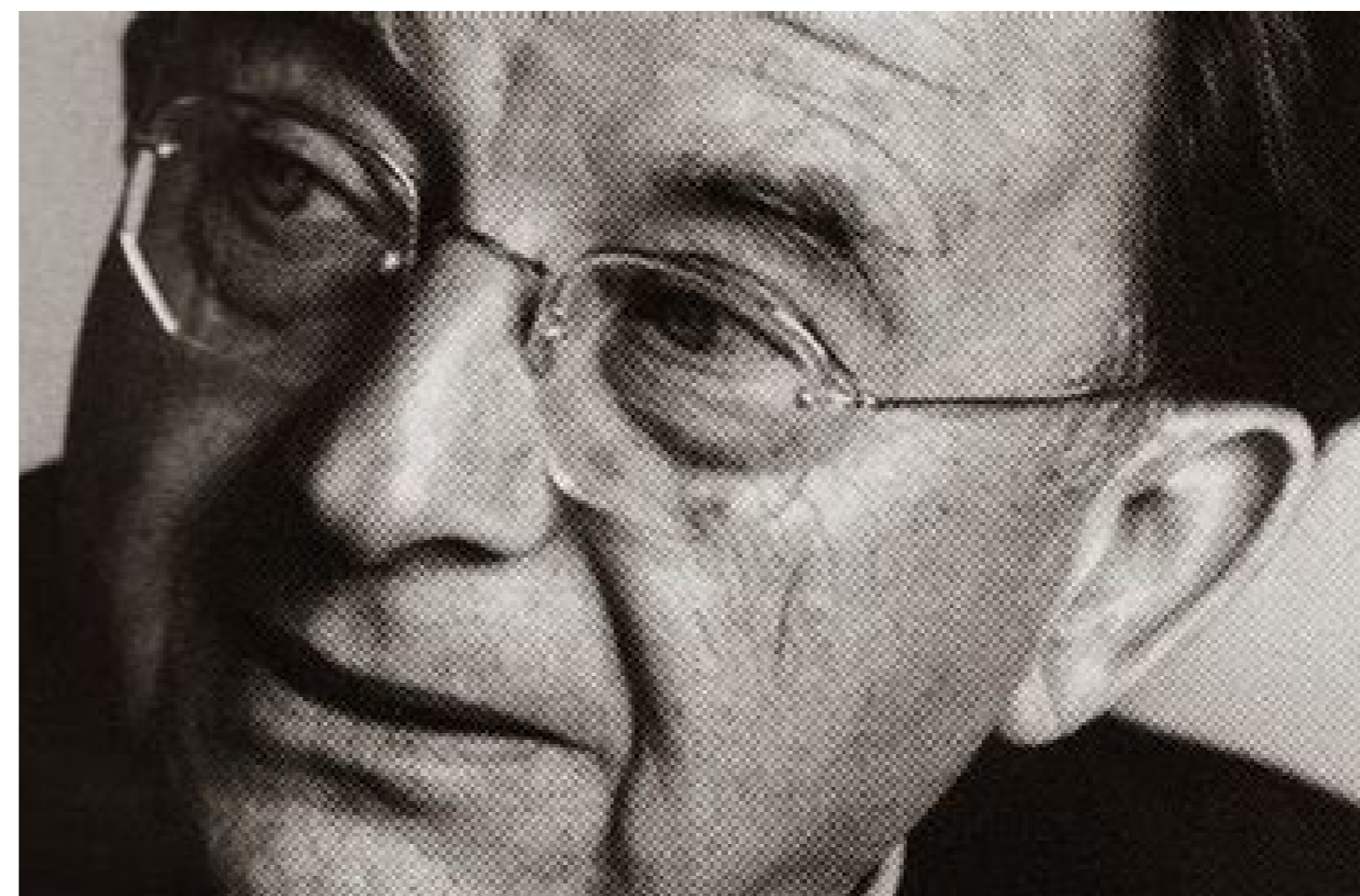

Erich Fromm

- Like Wilhelm Reich, Fromm was a social psychologist of the Frankfurt School who came to America in the 1930s.

- His book Escape from Freedom, published in 1941, is an ideological companion to Wilhelm Reich’s The Mass Psychology of Fascism.



William Wilberforce

On Friday July 26th 1833 as he lay on his deathbed Wilberforce exclaimed: "Thank God that I have lived to witness the day in which England is willing to give £20 million for the abolishment of slavery." (What would that be worth today ?) He died three days later.

The Slavery Abolition Bill 1833 passed through the House of Lords, it received the Royal Assent (which means it became law) on 29 August 1833 and came into force on 1 August 1834. On that date slavery was abolished throughout the vast British Empire. The Act automatically applied as new possessions (principally in Africa) subsequently became part of the British Empire.

To know who rules over you. Simply find out who it is that you are not allowed to criticise.Voltaire

We, as White people, have been GAGGED!! Then bullied, insulted, demonised, and provoked, until we object and complain. We then get called *dirty names* like Nazi, Racist, White Extremist, etc, etc.

Our weak & corrupt Lib/Lab/Con Politicians are the problem. As of Jan 2021, the UK elections are years away. Check out Populism, and Nationalism ASAP. Become "WHITE WOKE" & Push Back.

Do it today, NOW! 163

society just as Karl Marx and Georg Lukacs contemplated the disintegration of German society: "One can rightfully speak of a cultural revolution, since the protest is directed toward the whole cultural establishment, including the morality of existing society...there is one thing we can say with complete assurance: the traditional idea of revolution and the traditional strategy of revolution has ended. These ideas are old-fashioned...What we must undertake is a type of diffuse and dispersed disintegration of the system."

- Marcuse published Eros and Civilization in 1955, which became the founding document of the 1960s counterculture and brought the Frankfurt School into the colleges and universities of America.
- He asserted that the only way to escape the one-dimensionality of modern industrial society was to liberate the erotic side of man, the sensuous instinct, in rebellion against "technological rationality."
- This erotic liberation was to take the form of the "Great Refusal," a total rejection of the capitalist monster and its entire works, including technological reason and ritual-authoritarian language.
- He provided the obtuse intellectual justifications for adolescent sexual rebellion, and the slogan "Make Love, Not War."
- His theory included the belief that the Women's Liberation Movement was to be the most important component of the opposition, and potentially the most radical.
- His revolutionary efforts would blossom into a full-scale war by revolutionary Marxism against the European white male in the schools and colleges.

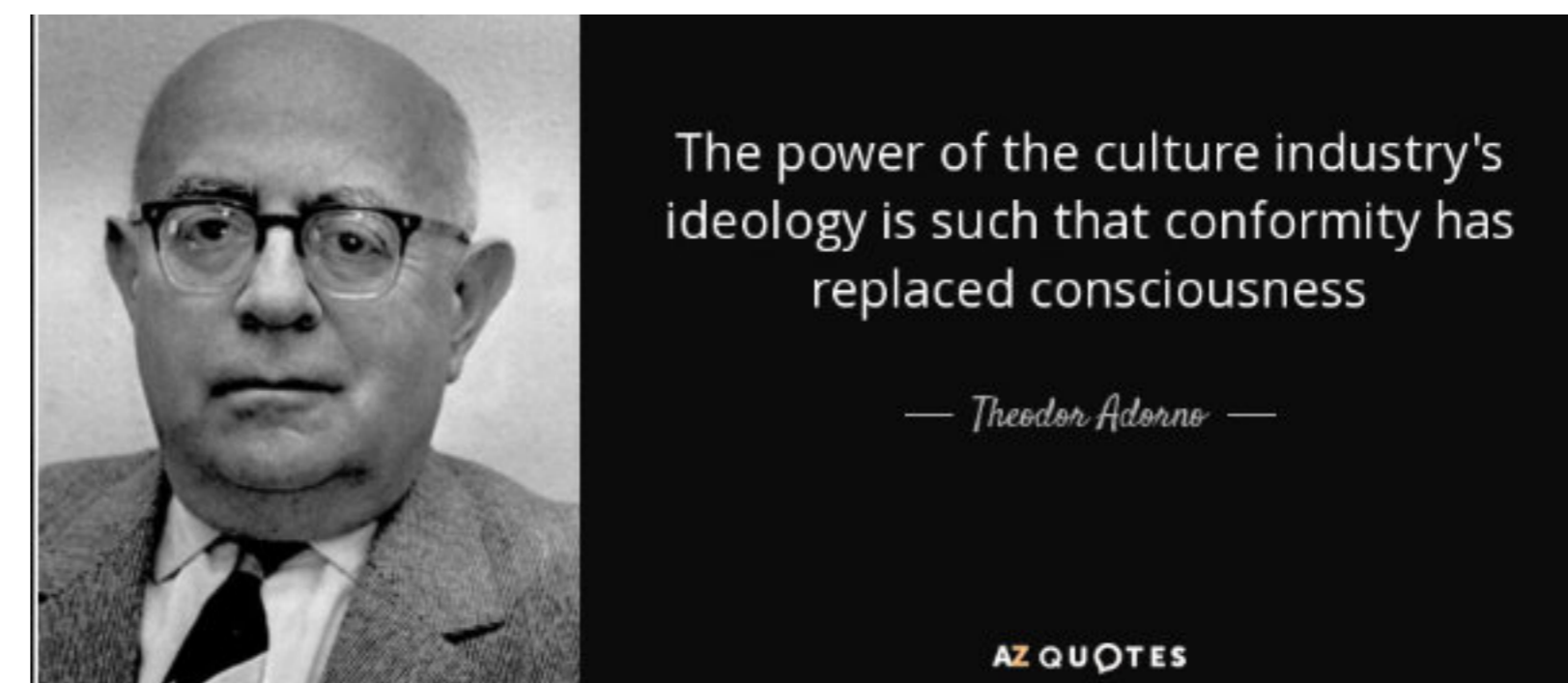

Theodor Adorno

- He was another Marxist revolutionary and member of the Frankfurt School who came to America in the 1930s.
- Along with others, Adorno authored The Authoritarian Personality, which was published in 1950.
- Adorno's book was inspired by the same kind of theoretical assertions revealed in the works of Wilhelm Reich, Erich Fromm and Herbert Marcuse based on analytical studies of German society that were begun in 1923.
- The basic theme was the same. There was such a thing as an authoritarian

• Fromm asserted that early capitalism created a social order that bred a sadomasochistic and authoritarian character of which Martin Luther and Adolph Hitler were prime examples.

• He asserted that the same capitalistic social order resulted in Calvin's Theory of Predestination, which reflected the principle of the basic inequality of men that was revived in Nazi ideology.

• He asserted the authoritarian character experiences only domination or submission and "differences, whether sex or race, to him are necessarily of superiority or inferiority."

• He asserted that "Positive Freedom" implies the principle that there is no higher power than the unique individual self; that man is the center and purpose of life; that the growth and realization of man's individuality is an end that can never be subordinated to purposes which are supposed to have a greater dignity.

• Fromm made the real meaning of this "Positive Freedom" clear in another of his many books – The Dogma of Christ... wherein he describes a revolutionary character such as himself as: the man who has emancipated himself from the ties of blood and soil, from his mother and father, and from special loyalties to state, race, party or religion.

• Fromm makes his revolutionary intent very clear in The Dogma of Christ... "We might define revolution in a psychological sense, saying that a revolution is a political movement led by people with revolutionary characters, and attracting people with revolutionary characters."

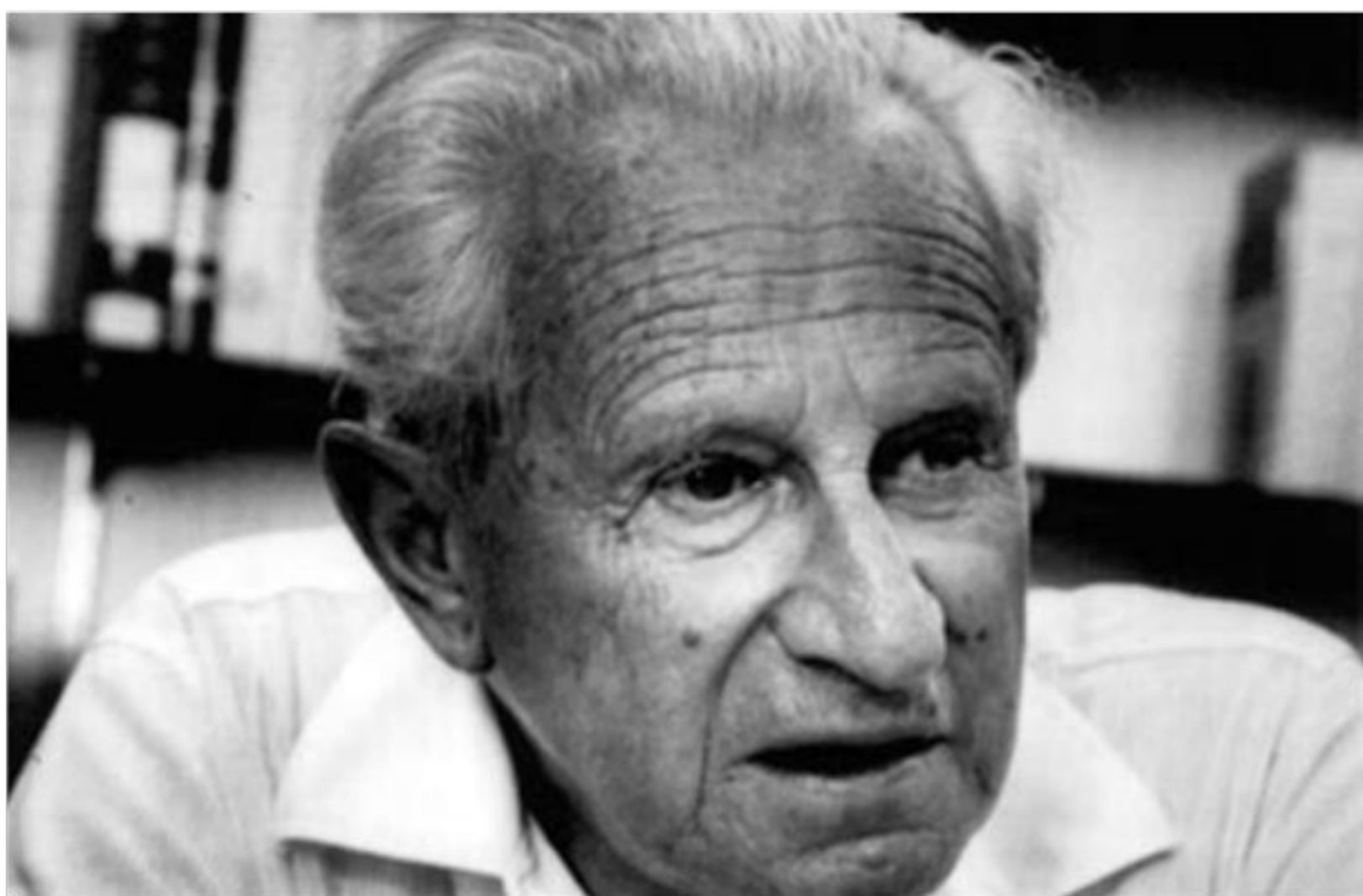

Herbert Marcuse

- Like Wilhelm Reich and Erich Fromm, Herbert Marcuse was an intellectual of the Frankfurt School who came to America in the 1930s.
- He has often been described as a Marxist philosopher, but he was in fact a fullblooded social revolutionary who contemplated the disintegration of American



William Wilberforce

On Friday July 26th 1833 as he lay on his deathbed Wilberforce exclaimed: "Thank God that I have lived to witness the day in which England is willing to give £20 million for the abolishment of slavery." (What would that be worth today ?) He died three days later.

The Slavery Abolition Bill 1833 passed through the House of Lords, it received the Royal Assent (which means it became law) on 29 August 1833 and came into force on 1 August 1834. On that date slavery was abolished throughout the vast British Empire. The Act automatically applied as new possessions (principally in Africa) subsequently became part of the British Empire.

To know who rules over you. Simply find out who it is that you are not allowed to criticise.Voltaire

We, as White people, have been GAGGED!! Then bullied, insulted, demonised, and provoked, until we object and complain. We then get called *dirty names* like Nazi, Racist, White Extremist, etc, etc.

Our weak & corrupt Lib/Lab/Con Politicians are the problem. As of Jan 2021, the UK elections are years away. Check out Populism, and Nationalism ASAP. Become "WHITE WOKE" & Push Back.

Do it today, NOW!



The timid civilized world has found nothing with which to oppose the onslaught of a sudden revival of barefaced barbarity, other than concessions and smiles.

— Aleksandr Solzhenitsyn —

AZ QUOTES



character that was the opposite of the desired revolutionary character. This authoritarian character was a product of capitalism, Christianity, conservatism, the patriarchal family and sexual repression. In Germany, this combination induced prejudice, anti-Semitism and fascism according to Frankfurt School theory.

- It so happened that most Americans were products of capitalism, Christianity, conservatism, the patriarchal family and sexual repression in their youth. So Theodor Adorno and other members of the Frankfurt School had a golden opportunity to execute Georg Lukacs's and Antonio Gramsci's program for creating social revolution in America instead of Germany.
- They would posit the existence of authoritarian personalities among Americans with tendencies toward prejudice, and then exploit this to force the "scientifically planned re-education" of Americans with the excuse that it was being done in order to eradicate prejudice.
- This scientifically-planned re-education would become the master plan for the transformation of America's system of fundamental values into their opposite revolutionary values in American education so that school children would become replicas of the Frankfurt School revolutionary characters and thus create the New American Child.
- This can be confirmed by noting that The Authoritarian Personality is the key source of the affective domain of Benjamin Bloom's Taxonomy of Educational Objectives of 1964, which guided the education cartel thereafter.

"You must understand, the leading Bolsheviks who took over Russia were not Russians. They hated Russians. They hated Christians. Driven by ethnic hatred they tortured and slaughtered millions of Russians without a shred of human remorse. It cannot be overstated. Bolshevism committed the greatest human slaughter of all time. The fact that most of the world is ignorant and uncaring about this enormous crime is proof that the global media is in the hands of the perpetrators."

~ Alexandr Solzhenitsyn

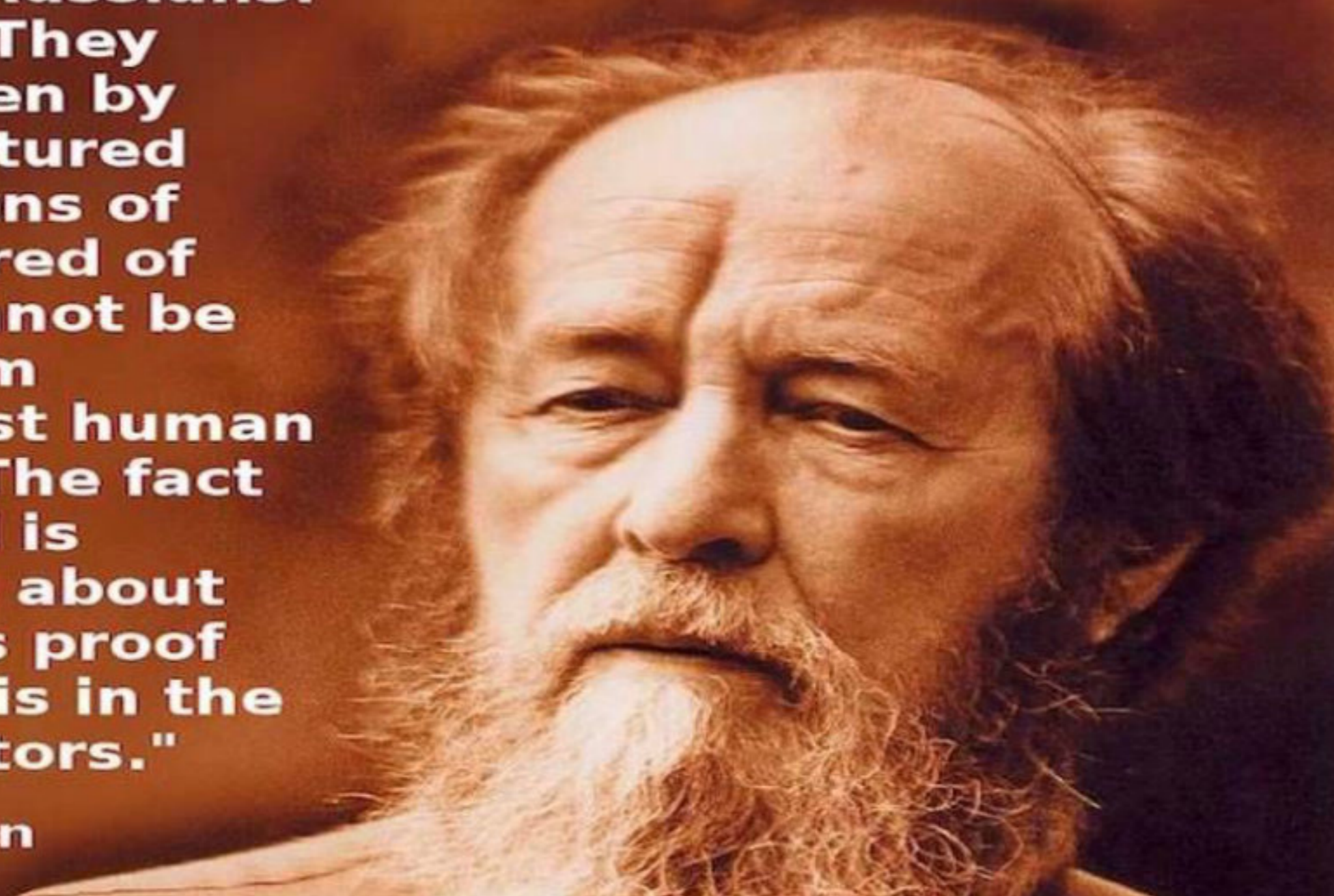



William Wilberforce
On Friday July 26th 1833 as he lay on his deathbed Wilberforce exclaimed: "Thank God that I have lived to witness the day in which England is willing to give £20 million for the abolishment of slavery." (What would that be worth today ?)
He died three days later.

The Slavery Abolition Bill 1833 passed through the House of Lords, it received the Royal Assent (which means it became law) on 29 August 1833 and came into force on 1 August 1834. On that date slavery was abolished throughout the vast British Empire. The Act automatically applied as new possessions (principally in Africa) subsequently became part of the British Empire.

To know who rules over you. Simply find out who it is that you are not allowed to criticise.Voltaire

We, as White people, have been GAGGED!! Then bullied, insulted, demonised, and provoked, until we object and complain. We then get called *dirty names* like Nazi, Racist, White Extremist, etc, etc.

Our weak & corrupt Lib/Lab/Con Politicians are the problem. As of Jan 2021, the UK elections are years away. Check out Populism, and Nationalism ASAP. Become "WHITE WOKE" & Push Back.

Do it today, NOW! 165

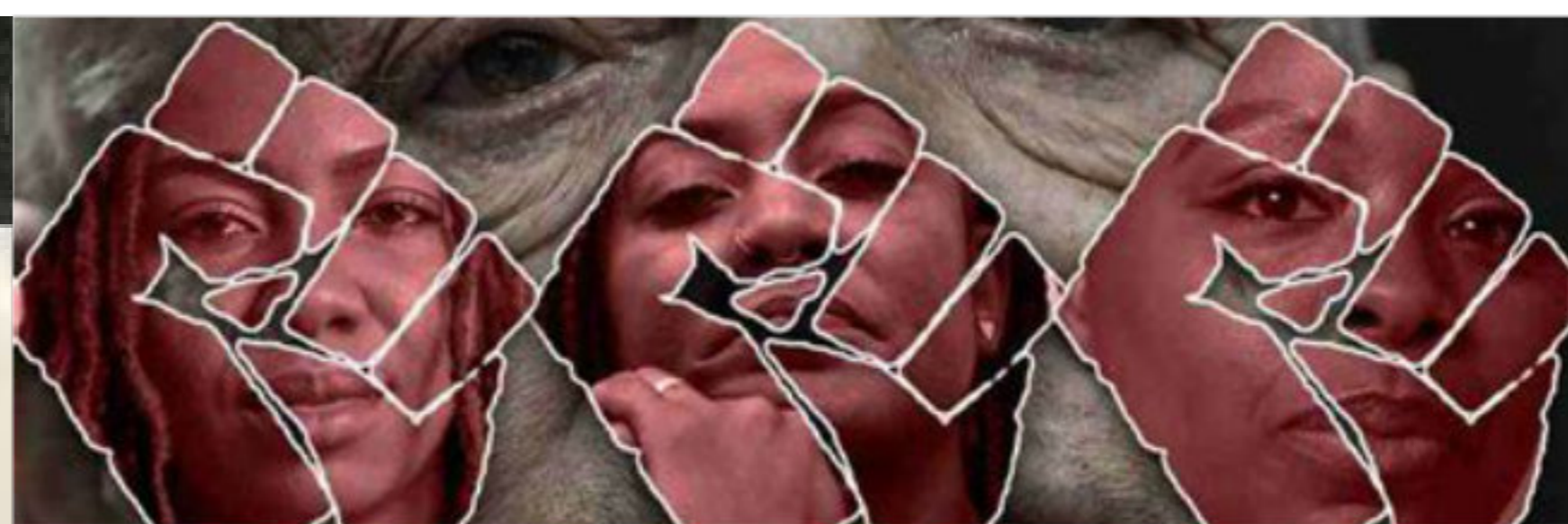

"WE ARE TRAINED MARXISTS."

-PATRISSE CULLORS, COFOUNDER OF BLACK LIVES MATTER



WILL WITT INTERVIEWS EXPERT:

'BLACK LIVES MATTER' IS A MARXIST MOVEMENT



William Wilberforce

On Friday July 26th 1833 as he lay on his deathbed Wilberforce exclaimed: "Thank God that I have lived to witness the day in which England is willing to give £20 million for the abolishment of slavery." (What would that be worth today ?)

He died three days later.

The Slavery Abolition Bill 1833 passed through the House of Lords, it received the Royal Assent (which means it became law) on 29 August 1833 and came into force on 1 August 1834. On that date slavery was abolished throughout the vast British Empire.

The Act automatically applied as new possessions (principally in Africa) subsequently became part of the British Empire.

To know who rules over you. Simply find out who it is that you are not allowed to criticise.Voltaire

We, as White people, have been GAGGED!! Then bullied, insulted, demonised, and provoked, until we object and complain. We then get called *dirty names* like Nazi, Racist, White Extremist, etc, etc.

Our weak & corrupt Lib/Lab/Con Politicians are the problem. As of Jan 2021, the UK elections are years away. Check out Populism, and Nationalism ASAP. Become "WHITE WOKE" & Push Back.

Do it today, NOW!

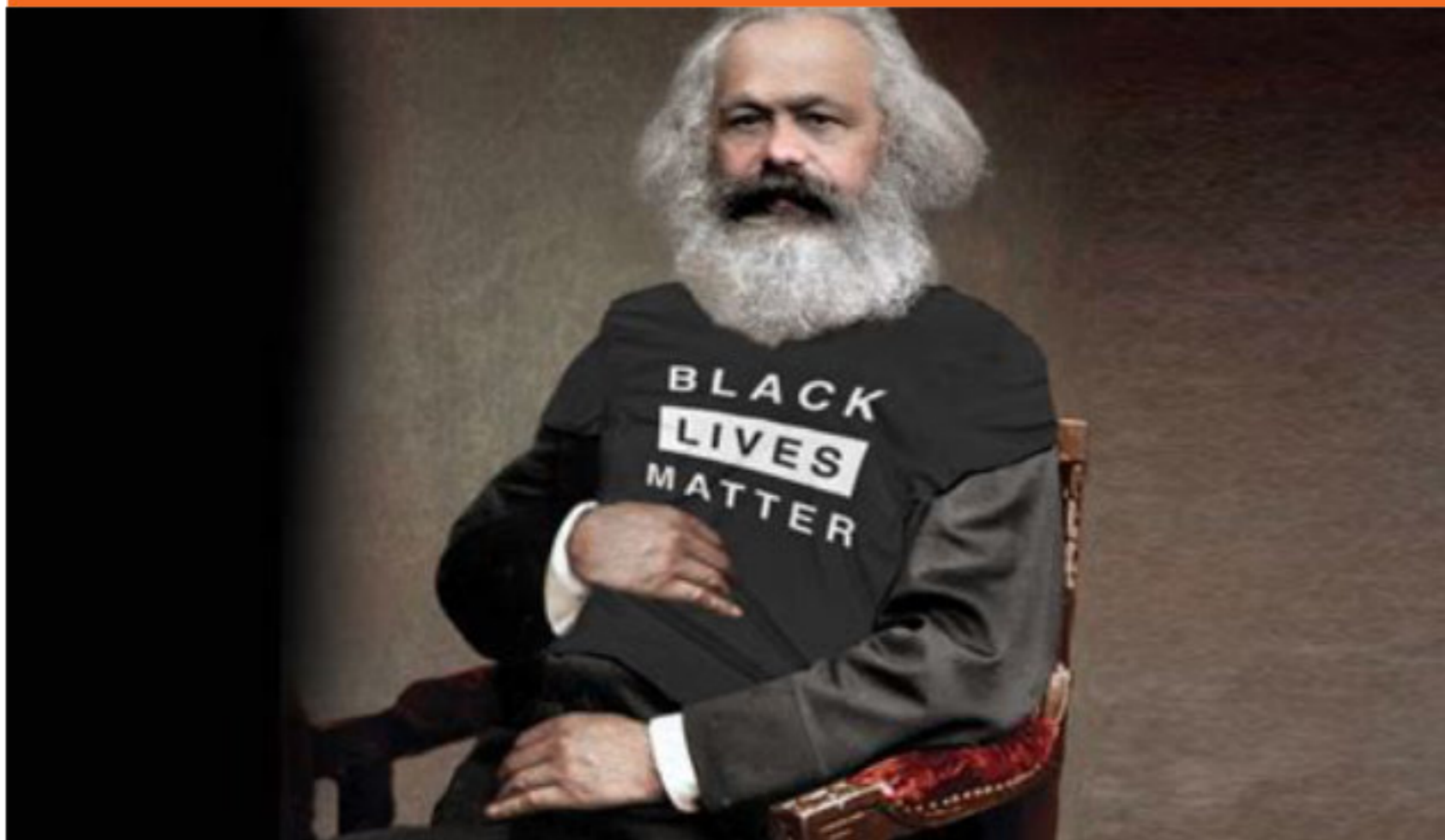

Blacks Lured by Marxists

BLACK LIVES MATTER DOES NOT CARE FOR BLACK PEOPLE, THEY ONLY USE THEM FOR THEIR AGENDA. THESE COMMUNISTS USE "RACISM" TO MANIPULATE US INTO DIVISION.



William Wilberforce
On Friday July 26th 1833 as he lay on his deathbed Wilberforce exclaimed: "Thank God that I have lived to witness the day in which England is willing to give £20 million for the abolishment of slavery." (What would that be worth today ?)
He died three days later.

The Slavery Abolition Bill 1833 passed through the House of Lords, it received the Royal Assent (which means it became law) on 29 August 1833 and came into force on 1 August 1834. On that date slavery was abolished throughout the vast British Empire. The Act automatically applied as new possessions (principally in Africa) subsequently became part of the British Empire.

To know who rules over you. Simply find out who it is that you are not allowed to criticise.Voltaire

We, as White people, have been GAGGED!! Then bullied, insulted, demonised, and provoked, until we object and complain. We then get called *dirty names* like Nazi, Racist, White Extremist, etc, etc.

Our weak & corrupt Lib/Lab/Con Politicians are the problem. As of Jan 2021, the UK elections are years away. Check out Populism, and Nationalism ASAP. Become "WHITE WOKE" & Push Back. **Do it today, NOW!**

"FACT: Black Lives Matter riots have destroyed more innocent black lives in the last month than white police officers have in a decade."
— CANDACE OWENS

Candace Owens @RealCandaceO
These images capture the horrific scene that took place outside of the Capitol building today. Truly disgraceful. Oh wait—my mistake. These are actually from the BLM "protests" over the summer.



Candace Owens @RealCandaceO
Black Lives Matter is an organization of white men, using the faces of dead black people, to raise millions of dollars toward electing white Democrats into positions of power. It is the most flagrantly racist organization in America.

MAGAPatriot Steve @RealMAGASteve
"The world is changing before our eyes. Tonight at Stanford, a black student stepped to the mic. He said he used to support BLM until he researched their lies. He shouted to a packed room "BUT NOW I'M FREE". The Black Revolution is unfolding and it's beautiful" —Candace Owens



Candace Owens @RealCandaceO
Confession: #GeorgeFloyd is neither a martyr or a hero. But I hope his family gets justice.



Candace Owens @RealCandaceO
Confession: #GeorgeFloyd is neither a martyr or a hero. But I hope his family gets justice. pscp.tv

"You know you live in a great country when even the people that absolutely detest it, refuse to leave."

"There are millions of black people who wake up every day and do the right thing. We do not riot. We do not loot. We do not do drugs. We do not disrespect law enforcement. We are tired of having our image tainted by the radical leftist anarchist black lives matter movement."
— Candace Owens

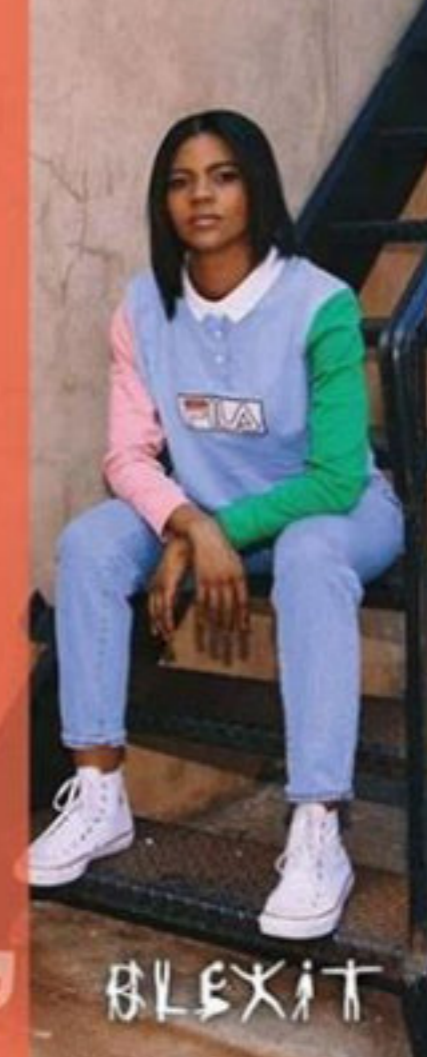

Candace Owens @RealCandaceO
Why does this happen? Because pea-brained celebrities that are idolized like @KingJames tell young black men that they are "literally being hunted". This is the natural result of such hyperbolic, dishonest rhetoric. The racist, anti-police, black lives matter LIE is to blame.

Candace Owens
WHERE IS THE BLM MONEY GOING?!



A socialist is someone who has read Lenin and Marx. An anti-socialist is someone who understands Lenin and Marx.

— Ronald Reagan —

AZ QUOTES



It's not the people who vote that count. It's the people who count the votes.

— Joseph Stalin —

AZ QUOTES

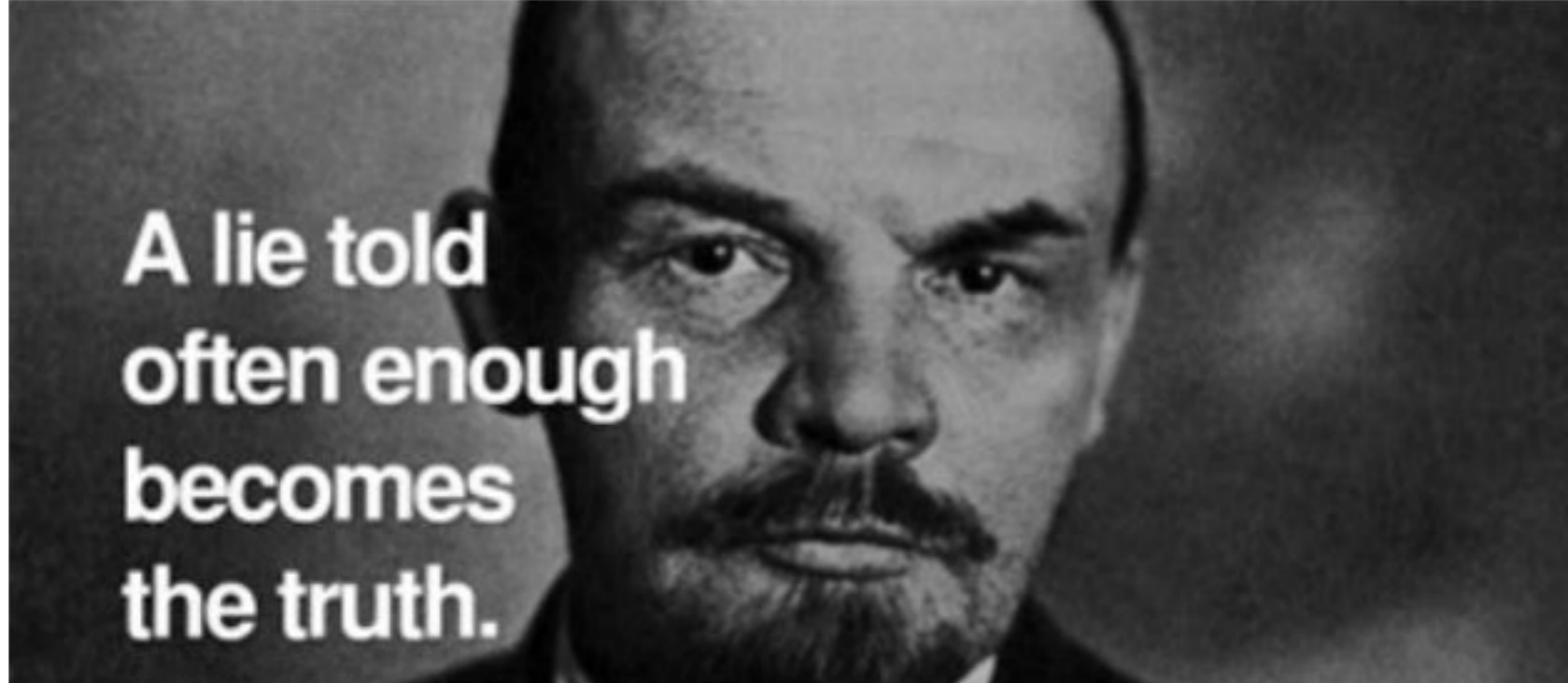

A lie told often enough becomes the truth.



No Marxist can deny that the interests of socialism are higher than the interests of the right of nations to self-determination.

— Vladimir Lenin —

AZ QUOTES

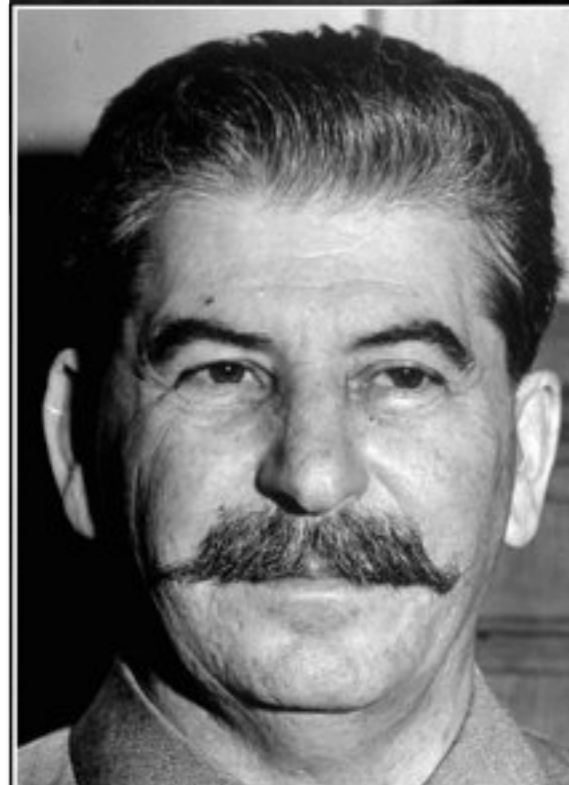

America is like a healthy body and its resistance is threefold: its patriotism, its morality and its spiritual life. If we can undermine these three areas, America will collapse from within.

— Joseph Stalin —

AZ QUOTES



The best way to control the opposition is to lead it ourselves.

— Vladimir Lenin —

AZ QUOTES



The Revolution won't happen with guns, rather it will happen incrementally, year by year, generation by generation. We will gradually infiltrate their educational institutions and their political offices, transforming them slowly into Marxist entities as we move towards universal egalitarianism.

— Max Horkheimer —

AZ QUOTES



We are indebted to Marx, Engels, Lenin and Stalin for giving us a weapon. The weapon is not a machine-gun, but Marxism-Leninism.

— Mao Zedong —

AZ QUOTES



William Wilberforce

On Friday July 26th 1833 as he lay on his deathbed Wilberforce exclaimed: "Thank God that I have lived to witness the day in which England is willing to give £20 million for the abolishment of slavery." (What would that be worth today ?) He died three days later.

The Slavery Abolition Bill 1833 passed through the House of Lords, it received the Royal Assent (which means it became law) on 29 August 1833 and came into force on 1 August 1834. On that date slavery was abolished throughout the vast British Empire. The Act automatically applied as new possessions (principally in Africa) subsequently became part of the British Empire.

To know who rules over you. Simply find out who it is that you are not allowed to criticise.Voltaire

We, as White people, have been GAGGED!! Then bullied, insulted, demonised, and provoked, until we object and complain. We then get called *dirty names* like Nazi, Racist, White Extremist, etc, etc.

Our weak & corrupt Lib/Lab/Con Politicians are the problem. As of Jan 2021, the UK elections are years away. Check out Populism, and Nationalism ASAP. Become "WHITE WOKE" & Push Back.

Do it today, NOW!



**Now then.
What were you taught in school
today, about the Slave Trade ?
Along with other lies, and half truths.**

**William Wilberforce**

On Friday July 26th 1833 as he lay on his deathbed Wilberforce exclaimed: "Thank God that I have lived to witness the day in which England is willing to give £20 million for the abolishment of slavery." (What would that be worth today ?)

He died three days later.

The Slavery Abolition Bill 1833 passed through the House of Lords, it received the Royal Assent (which means it became law) on 29 August 1833 and came into force on 1 August 1834. On that date slavery was abolished throughout the vast British Empire.

The Act automatically applied as new possessions (principally in Africa) subsequently became part of the British Empire.

To know who rules over you. Simply find out who it is that you are not allowed to criticise.Voltaire

We, as White people, have been GAGGED!! Then bullied, insulted, demonised, and provoked, until we object and complain. We then get called *dirty names* like Nazi, Racist, White Extremist, etc, etc.

Our weak & corrupt Lib/Lab/Con Politicians are the problem. As of Jan 2021, the UK elections are years away. Check out Populism, and Nationalism ASAP. Become "WHITE WOKE" & Push Back.

Do it today, NOW!

Keep people from their **history**,
and they are **easily controlled.**

— Karl Marx —

AZ QUOTES

The Post Democratic Age

David Hamilton

Slowly, and the elites hope imperceptibly, we are being brought under repressive state control operated by not only the police but also bureaucrats. It goes largely unnoticed because the new laws and regulations seem unconnected and journalists and opposition politicians are part of the same ruling caste.

But if you look at the new laws and regulations as a trend rather than independent Acts it becomes clear.

"Your papers please" is a phrase associated with Hitler's Gestapo when people without papers were taken to detention centres but it is beginning here.

The Daily Mail of , 21 March 2007: "British citizens will be quizzed on up to 200 different pieces of personal information in a 30 minute grilling when they apply for a passport. Those who fail to convince the bureaucrats they are who they say will be denied a travel document or face a full investigation by anti-fraud experts. There is no formal appeal process."



Peter Mandelson, the European Trade Commissioner once said: "We are now entering the post-democratic age."

To put it more directly, an era of the totalitarian control of people by the state. We are in the grip of a narrow ruling elite, an "Ideological Caste," that admits only those into power with the same views and expels after disgracing, any who dissent



Peter Mandelson with Jeffrey Epstein



as in the public humiliation and sacking of leading scientist Dr. James Watson. The "Ideological Caste" is made up of Cultural Marxists who earn vast sums of money and live in the best areas, send their children to the best schools but impose equality on the rest of us.

They are thought police but claim to be trying to correct centuries of unfairness, while in practice oppressing those with different views..
They call it tolerance.
They demonise their victims.

- if one opposes racially-based, privilege policies, one is racist; if one has religious convictions on sexuality, one is homophobic. They blame Western people for all evil in the world - the writers and heroes they promote are Marxist, Feminist, and homosexual. They believe if people can be moulded in a pre-ordained way they can make the world better and they have the rigid conviction that they know best. In 2006 nine members of Strathclyde Fire and Rescue Service were disciplined for refusing to hand out leaflets at Pride Scotia in Glasgow. The Cowcaddens fire-fighters had been asked to hand out leaflets at the rally in a publicity exercise but refused on moral grounds. Fire chiefs in Strathclyde gave them diversity training. Then at the 2007 event Lothian and Borders Fire and Rescue staff joined the Gay



William Wilberforce
On Friday July 26th 1833 as he lay on his deathbed Wilberforce exclaimed: "Thank God that I have lived to witness the day in which England is willing to give £20 million for the abolishment of slavery." (What would that be worth today ?)
He died three days later.

The Slavery Abolition Bill 1833 passed through the House of Lords, it received the Royal Assent (which means it became law) on 29 August 1833 and came into force on 1 August 1834. On that date slavery was abolished throughout the vast British Empire. The Act automatically applied as new possessions (principally in Africa) subsequently became part of the British Empire.

To know who rules over you. Simply find out who it is that you are not allowed to criticise.Voltaire

We, as White people, have been GAGGED!! Then bullied, insulted, demonised, and provoked, until we object and complain. We then get called *dirty names* like Nazi, Racist, White Extremist, etc, etc.

Our weak & corrupt Lib/Lab/Con Politicians are the problem. As of Jan 2021, the UK elections are years away. Check out Populism, and Nationalism ASAP. Become "WHITE WOKE" & Push Back.

Do it today, NOW! 170



William Wilberforce

On Friday July 26th 1833 as he lay on his deathbed Wilberforce exclaimed: "Thank God that I have lived to witness the day in which England is willing to give £20 million for the abolishment of slavery." (What would that be worth today?)

He died three days later.

The Slavery Abolition Bill 1833 passed through the House of Lords, it received the Royal Assent (which means it became law) on 29 August 1833 and came into force on 1 August 1834. On that date slavery was abolished throughout the vast British Empire.

The Act automatically applied as new possessions (principally in Africa) subsequently became part of the British Empire.

To know who rules over you. Simply find out who it is that you are not allowed to criticise.Voltaire

We, as White people, have been GAGGED!! Then bullied, insulted, demonised, and provoked, until we object and complain. We then get called *dirty names* like Nazi, Racist, White Extremist, etc, etc.

Our weak & corrupt Lib/Lab/Con Politicians are the problem. As of Jan 2021, the UK elections are years away. Check out Populism, and Nationalism ASAP. Become "WHITE WOKE" & Push Back.

Do it today, NOW!

drivers' licences with these totalitarian devices. Alarmingly, some of the companies supplying the finger mapping systems to schools have connections with the American intelligence services and military operating at Guantanamo Bay.

I looked at the Identity & Passport Service Website: "ID cards will link your basic personal information to something uniquely yours - like the pattern of your iris, your face shape or your fingerprint. It will protect your identity from people fraudulently claiming to be you and make it easier for you to prove your identity when you need to - like opening a bank account, moving house, applying for benefits or starting a job." The Home Office website: "21 of the 25 E.U. Member States have already introduced ID cards." Officials from Government to Council Officers will have powers to investigate every phone call in Britain. Laws are being introduced to compel phone companies to keep all landline and mobile calls however private and allow 795 public bodies and Quangos to eavesdrop, tax authorities, 475 local councils, and a many other organisations, including the Food Standards Agency, the Department of Health, the Immigration Service, the Gaming Board and the Charity Commission. The initiative, formulated after the Madrid and London terrorist attacks of 2004 and 2005, was presented as a major weapon in the fight against terrorism. This is being introduced across Europe and originates with the bureaucrats who run the E.U.



The records will detail the calls made, their time, duration, and the name and address of the registered user of the phone. The files will show where people are at the time they make mobile phone calls and by knowing which mast transmitted the signal officials can pinpoint the source of a call to within a few feet. If you make a call from a moving car it can track your route and also allows police and security services to investigate with or without cause the phone records of British subjects and businesses. Files will also be kept of all sent and received text messages. By 2009 the Government plans to extend the rules to cover internet use: the websites we have visited, the people we have emailed and phone calls made over the net. This was introduced by the decree of Home Secretary Jacqui Smith. The new laws will make it a legal requirement for phone companies to keep

Pride march with fire engine, promotional 'fire hats' and public information leaflets on fire safety were handed out. They had been browbeaten into "new people." The watchword of the Cultural Marxists grew up in the 1960s: "Everything is Political." **Cultural Marxism is a total ideological system, supplying opinions for every aspect of life. It is a less brutal but more manipulative technological version of Stalin's Russia.** <http://www.historyguide.org/europe/stalin.html> **The plan is ideological: to create a new kind of society and a new human personality like Homo Sovieticus; Nazi ideology in Germany was similar with the utopia as a thousand year Reich of "pure Aryans" as was Pol Pot's ideology to build civilization anew by wiping out the existing people. These were not merely forms of government but a Weltanschauung, the German word for the phrase a "world-perspective." In the west it is the masses with their traditional values who must be changed.**

They start with those who can not object: people who apply for crisis loans from Income Support are told "The Department of Works and Pensions retain personal details on computer." These people are being classified by the Government. Britain has more than a fifth of the world's CCTV cameras. NHS records are to be put on a national computer spine accessible to thousands of health workers. Ministers want every British subject to have their DNA kept on a national database.

The school leaving age is being raised to 18, though education will not improve there will be more time for state parenting as in school holiday clubs and breakfast clubs. This is Totalitarianism and our children are being taken over by the state. It is to condition them for being monitored 24 hours a day.

The State has the DNA records of nearly a million children, some as young as five, and have been secretly taking their fingerprints since 2001 and nearly 6,000 pupils have had their prints taken. Each week 20 schools introduce fingerprinting. Ostensibly this electronic mapping system allows children to borrow books from the library and is exciting for the children and helps them develop a love of books and reading? It replaces library cards by the child's fingerprint and placing the print on a scanner opens their computer file with records of the books they have borrowed. They say this would greatly simplify record-keeping. The biometric data could be stolen by identity thieves.

Minister for Schools and Learning, Jim Knight, said that when working on a crime police have access to the children's fingerprints but parents are not notified of this treatment of their children. To remove the prints takes professional cleansing. The schools, education authorities and the Government say it is difficult to convert this code back though not impossible and a computer whizz-kid could re-create the original fingerprints for illicit purposes. To save our children we must set up Home Schooling networks and when the authorities try to impose restrictions, refuse them.

Identity theft is a common reason given for increasing regulation. Biometric information such as fingerprints cannot be changed like a PIN number and will be used to authenticate passports or bank accounts. People confuse I.D. like



William Wilberforce

On Friday July 26th 1833 as he lay on his deathbed Wilberforce exclaimed: "Thank God that I have lived to witness the day in which England is willing to give £20 million for the abolishment of slavery." (What would that be worth today ?)
He died three days later.

The Slavery Abolition Bill 1833 passed through the House of Lords, it received the Royal Assent (which means it became law) on 29 August 1833 and came into force on 1 August 1834. On that date slavery was abolished throughout the vast British Empire. The Act automatically applied as new possessions (principally in Africa) subsequently became part of the British Empire.

To know who rules over you. Simply find out who it is that you are not allowed to criticise.
.....Voltaire

We, as White people, have been GAGGED!! Then bullied, insulted, demonised, and provoked, until we object and complain. We then get called *dirty names* like Nazi, Racist, White Extremist, etc, etc.

Our weak & corrupt Lib/Lab/Con Politicians are the problem. As of Jan 2021, the UK elections are years away. Check out Populism, and Nationalism ASAP. Become "WHITE WOKE" & Push Back.
Do it today, NOW!

records for at least a year, and to make them available to the authorities. The measures were implemented after Smith signed a 'statutory instrument' on July 26 2007 which allows the Government to alter laws without a full act of Parliament. The move was waved through the House of Lords two days earlier without a debate. It puts into UK law a European Directive aimed at the 'investigation, detection and prosecution of serious crime'. Other organizations with access to the data include - the Royal Navy Regulating Branch, the Atomic Energy Authority Constabulary, the Department of Trade and Industry, NHS Trusts, ambulance and fire services, the Department of Transport and the Department for the Environment.

The Home Office claims there are safeguards as every authority had a nominated senior member of staff who was legally responsible for the use the phone data was put to, 'the integrity of the process' and for 'reporting errors'. A spokesman said: 'The most detailed level of data can be accessed only by law enforcement agencies such as the police. More basic access is available to local authority bodies such as trading standards and environmental health who can only use these powers to prevent and detect crime.' It is said that Councils would only use these powers in circumstances such as benefit fraud. They say the powers would only be used against non-payers of council tax or for parking fines as the sums involved are not enough to justify the use of this information or the costs of applying it.

In July 2006 The Observer reported that British children, possibly as young as six, will be subjected to compulsory fingerprinting under European Union rules being drawn up in secret. The prints will be stored on a database which could be shared with countries around the world. Under proposed laws being drawn up secretly by the European Commission's 'Article Six' committee, which is composed of representatives of the European Union's 25 member states, all children will have to attend a finger-printing centre to obtain an EU passport by June 2009 at the latest. The Home Office wants to include children in its biometric passport scheme in three years' time, and automatically transfer their details and fingerprints to the new national identity database when they are 16.

Millions of children as young as 11 are to have their fingerprints taken and stored on a Government database, according to leaked Whitehall plans. As it is more than one million people's genetic fingerprints have been added to the police DNA database. It is biggest in the world and stores details of over 4.5million people and covers one in 13 of the population - around 7.5 per cent. The rapid growth indicates the Government is underhandedly building a universal genetic database. 6.5m people are on the police fingerprint database and a third of 3,000 matches a month with samples taken from crime scenes. Around a third of all the DNA stored is taken from individuals who were not charged with any offence, and have no criminal record. There has been a massive rise in the number of children on the database which includes 150,000 under-16. The DNA records are taken whether a youngster has committed a crime or not and held on file until they die. Data has been used for genetic research without consent, including attempts to predict "ethnic appearance" from DNA profiles.

Government agencies could use the database to track political activists, find out who they are related to, or to refuse jobs to any classified "undesirable" or just business people or the unemployed. The Government built this database in their own interests and without public or Parliamentary debate. In the past, police could take a DNA sample only from suspects who were charged with a criminal offence, and it was destroyed if they were subsequently cleared or a prosecution dropped. But under reforms introduced in 2000 officers no longer have to erase innocent people's entries. In 2004 police were given the power to take DNA swabs from anyone placed under arrest.



War criminal Tony Blair insisted there should be "no limit" to the number on the database even innocent people not accused of an offence should be listed.

The Government will eventually link the database to its plans for ID cards, and then make DNA sampling universal. The latest published figures show 4,523,154 entries are held. A third are from those with no convictions or criminal record, suggesting that 1.5 million innocent people have their DNA stored. At this rate the database will have nearly 10 million profiles by 2011. There are 150,000 children aged 16 or under stored, 334,000 between 16 and 18 and about 50 under-tens on the database. The DNA of a seven-month-old girl was added. Police can take DNA samples from anyone who is arrested. Regardless of whether the suspect is accused of a serious offence or a trivial one like dropping litter. They use a swab to scrape a few cells from the inside of the suspect's cheek, and lab workers extract the unique DNA gene sequence which is then uploaded to the database. Even if the case is dropped, the samples are kept on file. Police also take DNA from arrested children without parents permission. One can write to a chief constable asking for an entry to be deleted if they can prove they are an "exceptional case". But this is very difficult.

A proposed law giving unelected bureaucrats powers to punish people for offences instead of going to court will give civil servants the power to issue fines, was unjust and oppressive and could cause untold misery for businesses. Anyone affected would have to appeal to a tribunal to challenge a ruling" and pay their own legal bills. The legislation returns to the House of Lords today for a final day of debate before it moves to the Commons.



William Wilberforce

On Friday July 26th 1833 as he lay on his deathbed Wilberforce exclaimed: "Thank God that I have lived to witness the day in which England is willing to give £20 million for the abolishment of slavery." (What would that be worth today?)

He died three days later.

The Slavery Abolition Bill 1833 passed through the House of Lords, it received the Royal Assent (which means it became law) on 29 August 1833 and came into force on 1 August 1834. On that date slavery was abolished throughout the vast British Empire.

The Act automatically applied as new possessions (principally in Africa) subsequently became part of the British Empire.

To know who rules over you. Simply find out who it is that you are not allowed to criticise.Voltaire

We, as White people, have been GAGGED!! Then bullied, insulted, demonised, and provoked, until we object and complain. We then get called *dirty names* like Nazi, Racist, White Extremist, etc, etc.

Our weak & corrupt Lib/Lab/Con Politicians are the problem. As of Jan 2021, the UK elections are years away. Check out Populism, and Nationalism ASAP. Become "WHITE WOKE" & Push Back.

Do it today, NOW!

In an article "They also change the language," the Daily Express of July 3,2007 reported on moves towards totalitarian control of what we think through language.

"Gordon Brown has banned ministers from using the word "Muslim" in connection with Muslim terrorism. The Prime Minister has told his ministers that the phrase "war on -terror" is to be dropped. This is part of an attempt to improve community relations and avoid offending Muslims by adopting a more "consensual" tone than Blair. It is to mould our thinking. Home Secretary Smith is trying the old con of pretending political terrorists are criminals, "Let us be clear – terrorists are criminals, whose victims come from all walks of life, communities and religions. Terrorists attack the values shared by all law-abiding citizens. As a Government, as communities, as individuals, we need to ensure that the message of the terrorists is rejected." How, by changing their descriptions?

The Television companies are a vehicle of subtle tyranny and employees follow the movement or be put out of work. Vacancies in television were only ever advertised in the Guardian to make sure they only employed liberals and socialists. It helps ensure the right attitude in employees. Teaching posts were also advertised there too.

Following on the Religious Hatred Law which carries a 7 year penalty the totalitarian "Ideological Caste" is introducing anti homophobic laws that also has a 7 year penalty. If this is not tyranny I do not know what is. This is the counter culture of the 1960s making its moral values the basis of our law and oppressing the members of the public who are individual or think for themselves. As Christians once shaped society when sodomy was a crime, not a "lifestyle," the "lifestyle" view is now being enshrined in law and replacing the traditional view. As a judge put it "The Truth is no Defence." Just keep repeating the lie and prevent others from expressing opposition and soon there is a new reality supported by invented British history. Trevor Phillips openly called for British history to be rewritten at the 2007 Labour Party conference. The Commission for Equality and Human Rights has powers to impose their policies and the justification is upholding European Union laws on xenophobia and hate. To assert our identity is xenophobia – a criminal offence!

The Daily telegraph of 17 march 2008 reported that Harriet Harman, the Minister for Women, is considering scrapping current laws that stop employers from taking race or sex into consideration when interviewing candidates for jobs. White men could be stopped from getting jobs under government plans to allow employers to give ethnic minority and female candidates preferential treatment. The "doublespeak" is "positive action" and prevents applicants with better job credentials getting the job if they are the wrong sex or race. They are changing our morality from Traditional to a universal one based on equality but imposing Equality of Outcome. Their aim is the eradication of racism, sexism, class elitism the nation and the creation of pools of global cheap labour in a one-world or global state to be created in stages like the E.U.

In typical political jargon, ministers say the Regulatory Enforcement and Sanctions Bill is designed to take further important steps towards modern and effective regulatory enforcement. It will enable bureaucrats to issue fixed penalties to businesses of any size, as well as to individuals. The fines will range up to £3,500 " but could also include so-called unlimited variable penalties running into millions for big businesses and will harm businesses already struggling from 178 different Acts of Parliament. Like the other totalitarian states I have mentioned bureaucrats will be operating the law. Such regimes already exist with police cautions, (any crime which is thought possible to issue a caution for), on the spot fines for drunkenness; the Inland Revenue (penalties); Customs and Excise (now part of the combined Revenue and Customs department, HMRC) penalties; penalties for speeding, parking, littering etc.

Laws to protect people are being removed. A consequence of the Macpherson report is the reduction in legal protection for those under suspicion. Ostensibly, the repeal of Double Jeopardy in 2005 followed a marathon campaign by Ann Ming, after her daughter was murdered in 1989. Her killer, a violent alcoholic and acquitted in 1991, but later admitted his guilt, believing he would get away with the crime because of the traditional safeguard against tyrants charging people several times. Mrs.Ming, lobbied several Home Secretaries and won because the Macpherson report suggested double jeopardy should be abolished where there was "fresh and viable" new evidence. That happened in 2005, and in 2006 Dunlop was convicted. This was a convenient case to use because the removal of Double Jeopardy was a recommendation of the Macpherson Report into the murder of Stephen Lawrence and would enable the state to repeatedly try "racists" until they get a conviction.

The Pulborough Parish Council magazine reported that police were asking residents to report other residents for 'tailgating' or driving too close to another vehicle. What type of society calls on friends and neighbours to watch each other and report each other to the police apart from ours?- Mao's China, Stalinist Russia, the Eastern bloc 'Stasi' societies, and Nazi Germany. The police are being used to control people not to protect the public by stopping burglars, thieves, muggers, vandals, street beggars and drunkenness in public. They have given up on fighting crime to police our thoughts.

In Orwellian Doublethink, inequality is called equality; state control, freedom; persecution of the politically incorrect, tolerance; gender quotas equal opportunity and bigoted anti-racism that persecutes one race, whites! Language is the medium for transmitting thought and an embryonic totalitarian state gives words new meanings to shape thought for the new state. They believe reality is a social construct and if we can only think in the correct way reality will change. It is like the Sapir Whorf Hypothesis in linguistics which holds that without the word we cannot have the idea. But what about feelings? Without a wide and adequate grammar people become frustrated and angry as intelligent but inarticulate people do. We must do all in our power to expand our vocabularies and make sure our children are not denied the fullest English lexicon.

**William Wilberforce**

On Friday July 26th 1833 as he lay on his deathbed Wilberforce exclaimed: "Thank God that I have lived to witness the day in which England is willing to give £20 million for the abolishment of slavery." (What would that be worth today?)

He died three days later.

The Slavery Abolition Bill 1833 passed through the House of Lords, it received the Royal Assent (which means it became law) on 29 August 1833 and came into force on 1 August 1834. On that date slavery was abolished throughout the vast British Empire.

The Act automatically applied as new possessions (principally in Africa) subsequently became part of the British Empire.

To know who rules over you. Simply find out who it is that you are not allowed to criticise.
.....Voltaire

We, as White people, have been GAGGED!! Then bullied, insulted, demonised, and provoked, until we object and complain. We then get called *dirty names* like Nazi, Racist, White Extremist, etc, etc.

Our weak & corrupt Lib/Lab/Con Politicians are the problem. As of Jan 2021, the UK elections are years away. Check out Populism, and Nationalism ASAP. Become "WHITE WOKE" & Push Back.

Do it today, NOW!

ASK THE POWERFUL FIVE QUESTIONS

- ① WHAT POWER HAVE YOU GOT ?
- ② WHERE DID YOU GET IT FROM ?
- ③ IN WHOSE INTERESTS DO YOU EXERCISE IT ?
- ④ TO WHOM ARE YOU ACCOUNTABLE ?
- ⑤ HOW CAN WE GET RID OF YOU ?

ONLY DEMOCRACY
GIVES US THAT RIGHT

THAT IS WHY NO-ONE WITH
POWER LIKES DEMOCRACY

AND THAT IS WHY EVERY
GENERATION MUST STRUGGLE
TO WIN IT AND KEEP IT
— INCLUDING YOU AND ME
HERE AND NOW

TONY BENN
2005

Spin doctoring is to manipulate people into accepting what the elites are introducing.

One of the origins of Cultural Marxism was Anthony Crossland who destroyed Grammar Schools to turn the Working Classes into a Lumpenproletariat or Underclass.

Comprehensive schooling, by depriving people in the middle levels, of a proper historical and political education, has made manipulation easier as has teaching only small areas of history.

Children are taught to equate nationalism with Nazism. Our ancestors fought against tyranny and we must too! John Hampden's stand against King Charles I was heroic and he died in battle for his beliefs.

The struggle for trial by jury and Habeas Corpus, for the Right to Bear Arms for protection against the billeting of soldiers or searches of our houses must not be lost now to deception.

Macaulay's history tells of the Glorious Revolution of 1688, in which a courageous jury saved us from despotism - is inspirational.

The politicians then were cowardly and deceitful like the present lot but the core of the English people opposed tyranny as English men and women and defended national independence.

Sites of groups opposed to the new tyranny:

Statewatch : <http://www.statewatch.org>

Civil Liberty: <http://www.civilliberty.org.uk/>



William Wilberforce
On Friday July 26th 1833 as he lay on his deathbed Wilberforce exclaimed: "Thank God that I have lived to witness the day in which England is willing to give £20 million for the abolishment of slavery." (What would that be worth today ?)
He died three days later.

The Slavery Abolition Bill 1833 passed through the House of Lords, it received the Royal Assent (which means it became law) on 29 August 1833 and came into force on 1 August 1834. On that date slavery was abolished throughout the vast British Empire. The Act automatically applied as new possessions (principally in Africa) subsequently became part of the British Empire.

To know who rules over you. Simply find out who it is that you are not allowed to criticise.Voltaire

We, as White people, have been GAGGED!! Then bullied, insulted, demonised, and provoked, until we object and complain. We then get called *dirty names* like Nazi, Racist, White Extremist, etc, etc.

Our weak & corrupt Lib/Lab/Con Politicians are the problem. As of Jan 2021, the UK elections are years away. Check out Populism, and Nationalism ASAP. Become "WHITE WOKE" & Push Back.

Do it today, NOW! 175

NOTTING HILL for DUMMIES

At all future elections vote for one of the Populist or Nationalist parties.

Never again give your vote to any of the Lib/Lab/Con tricksters.

Check out the Populists and Nationalists. ASAP.

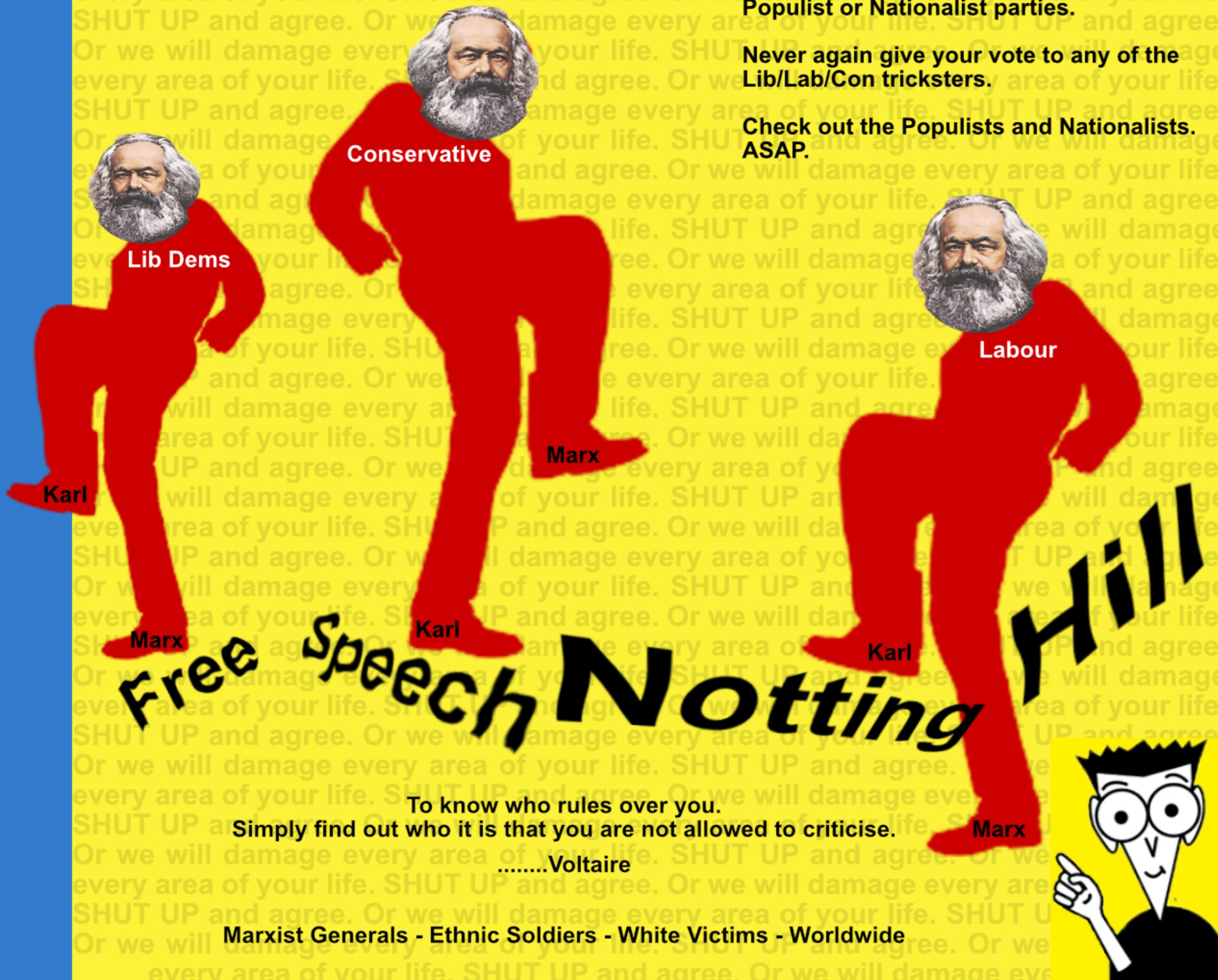

Free Speech Notting Hill

To know who rules over you. Simply find out who it is that you are not allowed to criticise.Voltaire

Marxist Generals - Ethnic Soldiers - White Victims - Worldwide

MEN OF CONVICTION !!!

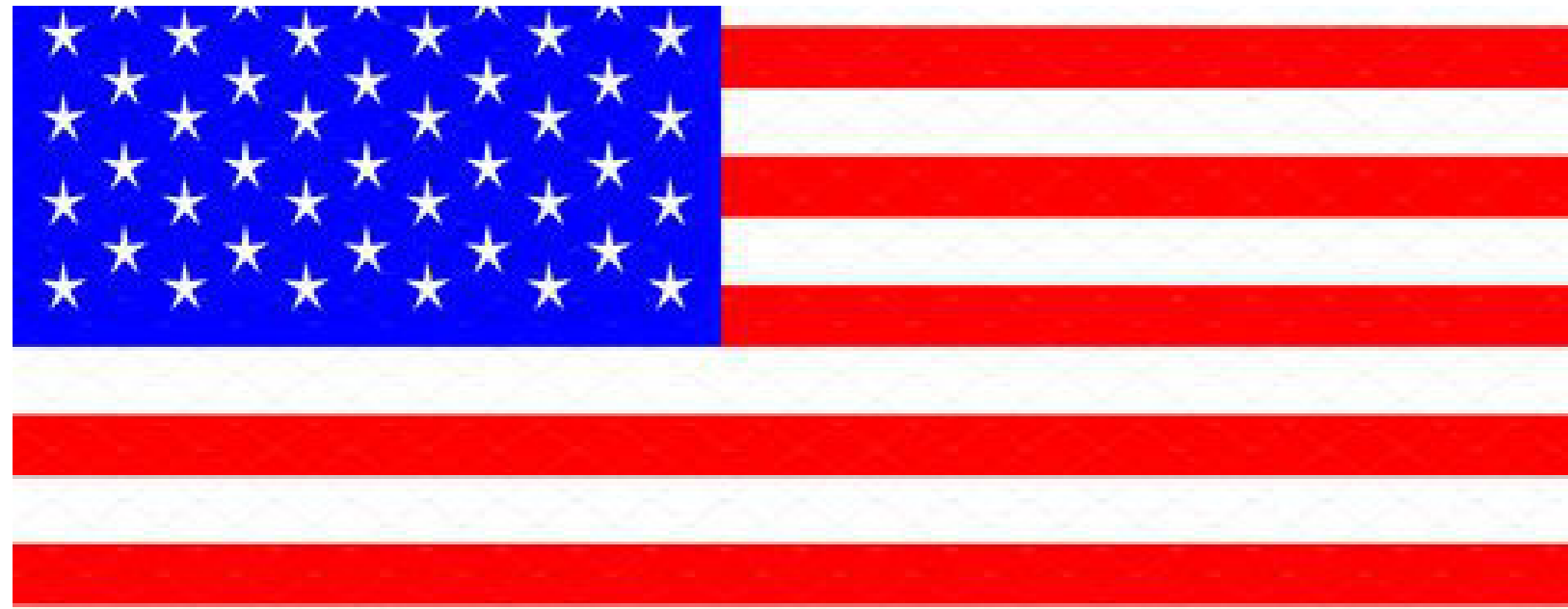

Mary Needham, President, Reserve Technology Inst.

Email: mneedham@iamerica.net

Have you ever wondered what happened to the 56 men who signed the American Declaration of Independence?

Five signers were captured by the British as traitors, and tortured before they died. Twelve had their homes ransacked and burned. Two lost their sons serving in the Revolutionary Army; another had two sons captured. Nine of the 56 fought and died from wounds or hardships of the Revolutionary War.

They signed and they pledged their lives, their fortunes, and their sacred honor.

What kind of men were they?

Twenty-four were lawyers and jurists. Eleven were merchants, nine were farmers and large plantation owners; men of means, well educated. But they signed the Declaration of Independence knowing full well that the penalty would be death if they were captured.

Carter Braxton of Virginia, a wealthy planter and trader, saw his ships swept from the seas by the British Navy. He sold his home and properties to pay his debts, and died in rags.

Thomas McKeam was so hounded by the British that he was forced to move his family almost constantly. He served in the Congress without pay, and his family was kept in hiding. His possessions were taken from him, and poverty was his reward.

Vandals or soldiers looted the properties of Dillery, Hall, Clymer, Walton, Gwinnett, Heyward, Rutledge, and Middleton. At the battle of Yorktown, Thomas Nelson Jr., noted that the British General Cornwallis had taken over the Nelson home for his head-quarters. He quietly urged General George Washington to open fire. The home was destroyed, and Nelson died bankrupt.

Francis Lewis had his home and properties destroyed. The enemy

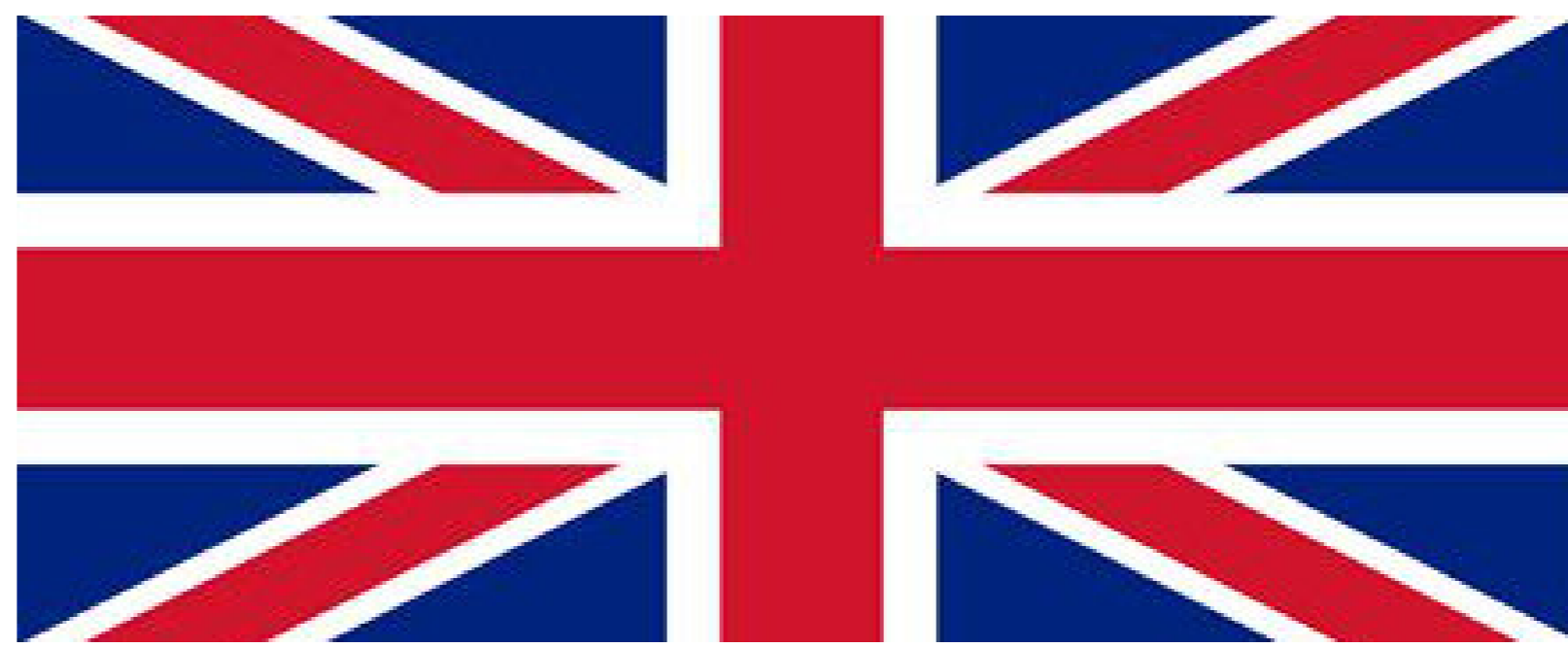

jailed his wife, and she died within a few months. John Hart was driven from his wife's bedside as she was dying. Their 13 children fled for their lives. His fields and his gristmill were laid to waste. For more than a year he lived in forests and caves, returning home to find his wife dead and his children vanished. A few weeks later he died from exhaustion and a broken heart.

Morris and Livingston suffered similar fates. Such were the stories and sacrifices of the American Revolution.

These were not wild-eyed, rabble-rousing ruffians. They were soft-spoken men of means and education. They had security, but they valued liberty more.

Standing tall, straight, and unwavering, they pledged: "For the support of this declaration, with firm reliance on the protection of the divine providence, we mutually pledge to each other our lives, our fortunes and our sacred honor."

They gave you and me a free and independent America. The history books never told you a lot about what happened in the Revolutionary War.

We didn't fight just the British.

We were British subjects at that time.

And we fought our own government!

Some of us take these liberties so much for granted, but we shouldn't. So take a few minutes while enjoying your 4th of July holiday and silently thank these patriots. It's not much to ask for the price they paid.

Remember: freedom is never free!

I hope you will show your support by please sending this to as many people as you can. It's time we get the word out that patriotism is NOT a sin and the Fourth of July has more to it than beer, picnics, and baseball games.



William Wilberforce

On Friday July 26th 1833 as he lay on his deathbed Wilberforce exclaimed: "Thank God that I have lived to witness the day in which England is willing to give £20 million for the abolishment of slavery." (What would that be worth today ?)

He died three days later.

The Slavery Abolition Bill 1833 passed through the House of Lords, it received the Royal Assent (which means it became law) on 29 August 1833 and came into force on 1 August 1834. On that date slavery was abolished throughout the vast British Empire.

The Act automatically applied as new possessions (principally in Africa) subsequently became part of the British Empire.

To know who rules over you. Simply find out who it is that you are not allowed to criticise.Voltaire

We, as White people, have been GAGGED!! Then bullied, insulted, demonised, and provoked, until we object and complain. We then get called *dirty names* like Nazi, Racist, White Extremist, etc, etc.

Our weak & corrupt Lib/Lab/Con Politicians are the problem. As of Jan 2021, the UK elections are years away. Check out Populism, and Nationalism ASAP. Become "WHITE WOKE" & Push Back.

Do it today, NOW!

In CONGRESS, July 4, 1776, The Unanimous Declaration Of The Thirteen United States Of America

When in the Course of human events, it becomes necessary for one people to dissolve the political bands which have connected them with another, and to assume among the Powers of the earth, the separate and equal station to which the Laws of Nature and of Nature's God entitle them, a decent respect to the opinions of mankind requires that they should declare the causes which impel them to the separation.

We hold these truths to be self-evident, that all men are created equal, that they are endowed by their Creator with certain unalienable Rights, that among these are Life, Liberty, and the pursuit of Happiness.

That to secure these rights, Governments are instituted among Men, deriving their just powers from the consent of the governed.

That whenever any Form of Government becomes destructive of these ends, it is the Right of the People to alter or to abolish it, and to institute new Government, laying its foundation on such principles and organizing its powers in such form, as to them shall seem most likely to effect their Safety and Happiness. Prudence, indeed, will dictate that Governments long established should not be changed for light and transient causes; and accordingly all experience hath shown, that mankind are more disposed to suffer, while evils are sufferable, than to right themselves by abolishing the forms to which they are accustomed. But when a long train of abuses and usurpations, pursuing invariably the same Object, evinces a design to reduce them under absolute Despotism, it is their right, it is their duty, to throw off such Government, and to provide new Guards for their future security.

Such has been the patient sufferance of these Colonies; and such is now the necessity which constrains them to alter their former Systems of Government. The history of the present King of Great Britain is a history of repeated injuries and usurpations, all having in direct object the establishment of an absolute Tyranny over these States. To prove this, let Facts be submitted to a candid world.

He has refused his Assent to Laws, the most wholesome and necessary for the public good.

He has forbidden his Governors to pass Laws of immediate and pressing

importance, unless suspended in their operation till his Assent should be obtained; and when so suspended, he has utterly neglected to attend to them.

He has refused to pass other Laws for the accommodation of large districts of people, unless those people would relinquish the right of Representation in the Legislature, a right inestimable to them and formidable to tyrants only.

He has called together legislative bodies at places unusual, uncomfortable, and distant from the depository of their public Records, for the sole purpose of fatiguing them into compliance with his measures.

He has dissolved Representative Houses repeatedly, for opposing with manly firmness his invasions on the rights of the people.

He has refused for a long time, after such dissolutions, to cause others to be elected; whereby the Legislative powers, incapable of Annihilation, have returned to the People at large for their exercise; the State remaining in the mean time exposed to all the dangers of invasion from without, and convulsions within.

He has endeavoured to prevent the population of these States; for that purpose obstructing the Laws of Naturalization of Foreigners; refusing to pass others to encourage their migrations hither, and raising the conditions of new Appropriations of Lands.

He has obstructed the Administration of Justice, by refusing his Assent to Laws for establishing Judiciary powers.

He has made Judges dependent on his Will alone, for the tenure of their offices, and the amount and payment of their salaries.

He has erected a multitude of New Offices, and sent hither swarms of Officers to harass our People, and eat out their substance.

He has kept among us, in times of peace, Standing Armies without the Consent of our legislatures.

He has affected to render the Military independent of and superior to the Civil power.



William Wilberforce

On Friday July 26th 1833 as he lay on his deathbed Wilberforce exclaimed: "Thank God that I have lived to witness the day in which England is willing to give £20 million for the abolishment of slavery." (What would that be worth today ?)
He died three days later.

The Slavery Abolition Bill 1833 passed through the House of Lords, it received the Royal Assent (which means it became law) on 29 August 1833 and came into force on 1 August 1834. On that date slavery was abolished throughout the vast British Empire. The Act automatically applied as new possessions (principally in Africa) subsequently became part of the British Empire.

To know who rules over you. Simply find out who it is that you are not allowed to criticise.
.....Voltaire

We, as White people, have been GAGGED!! Then bullied, insulted, demonised, and provoked, until we object and complain. We then get called *dirty names* like Nazi, Racist, White Extremist, etc, etc.

Our weak & corrupt Lib/Lab/Con Politicians are the problem. As of Jan 2021, the UK elections are years away. Check out Populism, and Nationalism ASAP. Become "WHITE WOKE" & Push Back.

Do it today, NOW!



William Wilberforce

On Friday July 26th 1833 as he lay on his deathbed Wilberforce exclaimed: "Thank God that I have lived to witness the day in which England is willing to give £20 million for the abolishment of slavery." (What would that be worth today ?)

He died three days later.

The Slavery Abolition Bill 1833 passed through the House of Lords, it received the Royal Assent (which means it became law) on 29 August 1833 and came into force on 1 August 1834. On that date slavery was abolished throughout the vast British Empire.

The Act automatically applied as new possessions (principally in Africa) subsequently became part of the British Empire.

To know who rules over you. Simply find out who it is that you are not allowed to criticise.Voltaire

We, as White people, have been GAGGED!! Then bullied, insulted, demonised, and provoked, until we object and complain. We then get called *dirty names* like Nazi, Racist, White Extremist, etc, etc.

Our weak & corrupt Lib/Lab/Con Politicians are the problem. As of Jan 2021, the UK elections are years away. Check out Populism, and Nationalism ASAP. Become "WHITE WOKE" & Push Back.

Do it today, NOW!

He has combined with others to subject us to a jurisdiction foreign to our constitution, and unacknowledged by our laws; giving his Assent to their Acts of pretended Legislation:

For quartering large bodies of armed troops among us:

For protecting them, by a mock Trial, from Punishment for any Murders which they should commit on the Inhabitants of these States:

For cutting off our Trade with all parts of the world:

For imposing Taxes on us without our Consent:

For depriving us in many cases, of the benefits of Trial by Jury:

For transporting us beyond Seas to be tried for pretended offences:

For abolishing the free System of English Laws in a neighbouring Province, establishing therein an Arbitrary government, and enlarging its Boundaries so as to render it at once an example and fit instrument for introducing the same absolute rule into these Colonies:

For taking away our Charters, abolishing our most valuable Laws, and altering fundamentally the Forms of our Governments:

For suspending our own Legislatures, and declaring themselves invested with power to legislate for us in all cases whatsoever.

He has abdicated Government here, by declaring us out of his Protection and waging War against us.

He has plundered our seas, ravaged our Coasts, burnt our towns, and destroyed the Lives of our people.

He is at this time transporting large armies of foreign mercenaries to compleat the works of death, desolation and tyranny, already begun with circumstances of Cruelty & perfidy scarcely paralleled in the most barbarous ages, and totally unworthy the Head of a civilized nation.

He has constrained our fellow Citizens taken Captive on the high Seas to bear Arms against their Country, to become the executioners of their friends and Brethren, or to fall themselves by their Hands.

He has excited domestic insurrections amongst us, and has endeavoured to bring on the inhabitants of our frontiers, the merciless Indian Savages, whose known rule of warfare, is an undistinguished destruction of all ages, sexes and conditions.

In every stage of these Oppressions We have Petitioned for Redress in the most humble terms: Our repeated Petitions have been answered only by repeated injury. A Prince, whose character is thus marked by every act which may define a Tyrant, is unfit to be the ruler of a free people.

Nor have We been wanting in attention to our British brethren. We have warned them from time to time of attempts by their legislature to extend an unwarrantable jurisdiction over us. We have reminded them of the circumstances of our emigration and settlement here. We have appealed to their native justice and magnanimity, and we have conjured them by the ties of our common kindred to disavow these usurpations, which would inevitably interrupt our connections and correspondence. They too have been deaf to the voice of justice and of consanguinity. We must, therefore, acquiesce in the necessity, which denounces our Separation, and hold them, as we hold the rest of mankind, Enemies in War, in Peace Friends.

We, therefore, the Representatives of the united States of America, in General Congress, Assembled, appealing to the Supreme Judge of the world for the rectitude of our intentions, do, in the Name, and by Authority of the good People of these Colonies, solemnly publish and declare,

That these United Colonies are, and of Right ought to be Free and Independent States; that they are Absolved from all Allegiance to the British Crown, and that all political connection between them and the State of Great Britain, is and ought to be totally dissolved; and that as Free and Independent States, they have full Power to levy War, conclude Peace, contract Alliances, establish Commerce, and to do all other Acts and Things which Independent States may of right do.

And for the support of this Declaration, with a firm reliance on the Protection of Divine Providence, we mutually pledge to each other our Lives, our Fortunes and our sacred Honor.

John Hancock

The 56 Signers of the American Declaration of Independence

New Hampshire

Josiah Bartlett
William Whipple
Mathew W. Thornton

Georgia

Button Gwinnett
Lyman Hall
Geo. Walton

North Carolina

William Hooper
Joseph Hewes
John Penn

Maryland

Samuel Chase
William Paca
Thomas Stone
Charles Carroll Of Carrollton

Massachusetts-Bay

Samule Adams
John Adams
Robert Treat Paine
Elbridge Gerry
John Hancock

Virginia

George Wythe
Richard Henry Lee
Thomas Jefferson
Benjamin Harrison
Thomas Nelson, Jr.
Francis Lightfoot Lee
Carter Braxton

South Carolina

Edward Rutledge
Thomas Heyward, Jr.
Thomas Lynch, Jr.
Arthur Middleton



Rhode Island

Stephen Hopkins
William Ellery

New York

William Floyd
Philip Livingston
Francis Lewis
Lewis Morris

New Jersey

Richard Stockton
John Witherspoon
Francis Hopkins
John Hart
Abraham Clark

Delaware

Caesar Rodney
George Read
Thomas M'Kean

Connecticut

Roger Sherman
Samuel Huntington
William Williams
Oliver Wolcott

Pennsylvania

Robert Morris
Benjamin Rush
Benjamin Franklin
John Morton
George Clymer
James Smith
George Taylor
James Wilson
George Ross



William Wilberforce

On Friday July 26th 1833 as he lay on his deathbed Wilberforce exclaimed: "Thank God that I have lived to witness the day in which England is willing to give £20 million for the abolishment of slavery." (What would that be worth today ?) He died three days later.

The Slavery Abolition Bill 1833 passed through the House of Lords, it received the Royal Assent (which means it became law) on 29 August 1833 and came into force on 1 August 1834. On that date slavery was abolished throughout the vast British Empire. The Act automatically applied as new possessions (principally in Africa) subsequently became part of the British Empire.

To know who rules over you. Simply find out who it is that you are not allowed to criticise.Voltaire

We, as White people, have been GAGGED!! Then bullied, insulted, demonised, and provoked, until we object and complain. We then get called *dirty names* like Nazi, Racist, White Extremist, etc, etc.

Our weak & corrupt Lib/Lab/Con Politicians are the problem. As of Jan 2021, the UK elections are years away. Check out Populism, and Nationalism ASAP. Become "WHITE WOKE" & Push Back.

Do it today, NOW!

Racial Envy

"The concept of envy — the hatred of the superior — has dropped out of our moral vocabulary ...

The idea that white Christian civilization is hated more for its virtues than its sins doesn't occur to us, because it's not a nice idea.

Western man towers over the rest of the world in ways so large as to be almost inexpressible.

It's Western exploration, science, and conquest that have revealed the world to itself.

Other races feel like subjects of Western power long after colonialism, imperialism, and slavery have disappeared.

The charge of racism puzzles whites who feel not hostility, but only baffled good will, because they don't grasp what it really means: humiliation.

The white man presents an image of superiority even when he isn't conscious of it.

And, superiority excites envy.

Destroying white civilization is the inmost desire of the league of designated victims we call minorities.

—Joseph Sobran (Sobran's — April 1997)"

The words "Racist" and "Racism" Just what do these words mean ?

"A RACIST is anyone who is winning an argument with a Labour Supporter/Liberal !"

I cant remember where I first saw this definition, but it seems to sum things up very nicely. We have problems because of the lack of precise definitions of what the words Racism or Racist mean. At the present time they have been made into emotional "CLICK" words with little or no meaning, other than the tone of voice used to say them at the time.

They have been designed to make people have a "Feel Bad" factor about something or someone, without really knowing why.

So far it has worked very well at doing this.

Getting the questions raised in peoples minds about just what the words Racist and Racism mean, would be a very good idea, but how ! Mr Average will not ask these questions unless forced to for some reason, and then will probably accept the most "comfortable" definitions given to him by someone else.

This is because Political Correctness has been used to place anyone who raises these questions, under suspicion of being guilty of "RACISM"

WOW !!

Even 'Al Capone' !!

Never had any rackets that were this good !!



Whites are only 10% of the Global population, and the only population in decline. Creating only 7% of the Worlds babies. Yet we are the most industrious and innovative race the World has ever known. Whites unlocked the secrets of DNA & Relativity, launched satelites etc. And very, very, much more

[Open](#)



William Wilberforce

On Friday July 26th 1833 as he lay on his deathbed Wilberforce exclaimed: "Thank God that I have lived to witness the day in which England is willing to give £20 million for the abolishment of slavery." (What would that be worth today ?)

He died three days later.

The Slavery Abolition Bill 1833 passed through the House of Lords, it received the Royal Assent (which means it became law) on 29 August 1833 and came into force on 1 August 1834. On that date slavery was abolished throughout the vast British Empire.

The Act automatically applied as new possessions (principally in Africa) subsequently became part of the British Empire.

To know who rules over you. Simply find out who it is that you are not allowed to criticise.Voltaire

We, as White people, have been GAGGED!! Then bullied, insulted, demonised, and provoked, until we object and complain. We then get called *dirty names* like Nazi, Racist, White Extremist, etc, etc.

Our weak & corrupt Lib/Lab/Con Politicians are the problem. As of Jan 2021, the UK elections are years away. Check out Populism, and Nationalism ASAP. Become "WHITE WOKE" & Push Back.

Do it today, NOW!

Contact: + Bits & Pieces + Kill A White On Sight



Sean Bryson.
Can be found on 'Gab' here.
https://gab.com/Sean_Bryson

Website
SeanBryson.com

Email contact
slaverypdf@protonmail.com



Made with
[Affinity Publisher](#) - and - [Affinity Photo](#)

[Download the latest version of this document.](#)

Get super secure Email from Switzerland.
<https://protonmail.com>



KILL A WHITE ON SIGHT

The leaflet above was being distributed by Black Lives Matter in Scotland, around June and July 2020.

So, they want to "Avenge Slavery" do they ? They need look no further than their own Black Race, in history, and in Africa today. Did you hear any outrage in the UK media about this leaflet ? No ? Me neither ! Can you imagine the Media outcry if BLM had said 'kill a Jew' or 'kill a Muslim' on sight !?

As of March 2021, you have to be very careful what you talk about in your own home in Scotland. In the UK it is already against the law to mention Jews as a group in certain conversations. Is the same now also going to apply to Blacks and Muslims in Scotland ?

We as White people, can no longer discuss, to defend against a common enemy. WAKE UP WHITE MAN !! GET WHITE WOKE !! AND DO IT DAMNED QUICK !!



William Wilberforce
On Friday July 26th 1833 as he lay on his deathbed Wilberforce exclaimed: "Thank God that I have lived to witness the day in which England is willing to give £20 million for the abolishment of slavery." (What would that be worth today ?)
He died three days later.

The Slavery Abolition Bill 1833 passed through the House of Lords, it received the Royal Assent (which means it became law) on 29 August 1833 and came into force on 1 August 1834. On that date slavery was abolished throughout the vast British Empire. The Act automatically applied as new possessions (principally in Africa) subsequently became part of the British Empire.

To know who rules over you. Simply find out who it is that you are not allowed to criticise.Voltaire

We, as White people, have been GAGGED!! Then bullied, insulted, demonised, and provoked, until we object and complain. We then get called *dirty names* like Nazi, Racist, White Extremist, etc, etc.

Our weak & corrupt Lib/Lab/Con Politicians are the problem. As of Jan 2021, the UK elections are years away. Check out Populism, and Nationalism ASAP. Become "WHITE WOKE" & Push Back.

Do it today, NOW!



Download my old Website in a Zip File.
Just over 400 MB file size.

[Download](#)



[Follow on Twitter](#)



[Follow on VK](#)



William Wilberforce

On Friday July 26th 1833 as he lay on his deathbed Wilberforce exclaimed: "Thank God that I have lived to witness the day in which England is willing to give £20 million for the abolishment of slavery." (What would that be worth today ?)

He died three days later.

The Slavery Abolition Bill 1833 passed through the House of Lords, it received the Royal Assent (which means it became law) on 29 August 1833 and came into force on 1 August 1834.

On that date slavery was abolished throughout the vast British Empire.

The Act automatically applied as new possessions (principally in Africa) subsequently became part of the British Empire.

To know who rules over you. Simply find out who it is that you are not allowed to criticise.Voltaire

We, as White people, have been GAGGED!! Then bullied, insulted, demonised, and provoked, until we object and complain. We then get called *dirty names* like Nazi, Racist, White Extremist, etc, etc.

Our weak & corrupt Lib/Lab/Con Politicians are the problem. As of Jan 2021, the UK elections are years away. Check out Populism, and Nationalism ASAP. Become "WHITE WOKE" & Push Back.

Do it today, NOW!

Black African Slave Traders Resisted Abolition by Britain	02	'RACE' THE FINAL FRONTIER & Kristen Clarke	106
African Chiefs Urged To Apologise For Slave Trade	07	Francis Crick Was a Race Realist, Too	107
European Imperialism Ended Slavery Worldwide	08	Global Genetic Warfare	109
Dixies Censored Subject: Black Slave Owners	12	Mentioning the Unmentionable	111
Slavery: The African Connection. Coast of Africa 1788	15	Videos - Immigrant Experience In Israel	114
Slavery And Race. Gerald A Foster	17	Videos - Immigration Into Britain	115
Slavery Myths Debunked	23	Videos - The Beginnings by Rudyard Kipling	116
In 1807 Britain Outlawed Slavery	26	Created Equal	117
Alex Haley - Roots Fraudster, Liar, Plagiariser	28	What Is Racism ? - Jared Taylor	122
Amistad Slave Ship: Cinque, Was Himself A Slave Trader	29	Race and Criminal Cowardice	125
Slavery and Race : Dr William Pierce	31	The Left And The Corruption Of Language And Thought	127
On Blaming White Folk For Slavery	34	Works For Me - Ethnic Recruitment	129
African Slave Trade: A History	37	Whites need not apply	136
Black African Slave Traders	38	Multiculturalism As a Tool To Divide And Conquer	138
Islamic Slavery And Racism	39	Domesticating People	142
Slavery In The Arab World	41	Guerilla War ? The elite's war on us, by immigrant proxy	146
Black Slaveowners And Slavemasters	42	Race and immigration in the West	150
Did African Slave Traders Sell Us Out	45	The Historical Roots of Political Correctness	157
Africa And The Atlantic Slave Trade	47	The Post Democratic Age	170
Slavery In Africa	48	MEN OF CONVICTION !!!	176
The Truth About Slavery	52	Racial Envy	180
Slavery: White Slaves African Masters	55	Contact: + Bits & Pieces + Kill A White On Sight	181
Barbary Pirates and English Slaves	56		
Whites Were Slaves In North Africa	57		
Barbary Slaves: White Slaves and North African Pirates	60		
Jews And The White Slave Trade	62		
Contraband Women Naive Slavic Women In Israel	65		
Sex Slavery In Israel Today	69		
FOR DUMMIES	72		
It's A Wonderful Race ! By James Bronson	74		
Dr Noel Ignatiev - Destroy The White Race	81		
The World Is A Better Place Because Of The White Man	82		
So! These People Don't Like Us Whites !!!	90		
Kriss Donald 15 - Did Anyone Take The Knee ?	91		
Shaun Bailey - The Man Who Would Be Mayor	96		
Videos About Slavery	105		



William Wilberforce

On Friday July 26th 1833 as he lay on his deathbed Wilberforce exclaimed: "Thank God that I have lived to witness the day in which England is willing to give £20 million for the abolishment of slavery." (What would that be worth today ?) He died three days later.

The Slavery Abolition Bill 1833 passed through the House of Lords, it received the Royal Assent (which means it became law) on 29 August 1833 and came into force on 1 August 1834. On that date slavery was abolished throughout the vast British Empire. The Act automatically applied as new possessions (principally in Africa) subsequently became part of the British Empire.

To know who rules over you. Simply find out who it is that you are not allowed to criticise.Voltaire

We, as White people, have been GAGGED!! Then bullied, insulted, demonised, and provoked, until we object and complain. We then get called *dirty names* like Nazi, Racist, White Extremist, etc, etc.

Our weak & corrupt Lib/Lab/Con Politicians are the problem. As of Jan 2021, the UK elections are years away. Check out Populism, and Nationalism ASAP. Become "WHITE WOKE" & Push Back.